



ECLAIRAGE

EDITION 10/2000

CITROËN

F

Nos produits recouvrent une approbation obligatoire de notre Laboratoire et de notre Service Médical sur les compositions chimiques et sur leur nature à préserver l'homme et son environnement. Toutes ces informations sont contenues dans les Fiches de Données de Sécurité. Tout utilisateur en contact avec des produits dangereux doit pouvoir en prendre connaissance.

Vous pouvez les consulter sur INTERNET : <http://www.quickfds.com>.

 Afin d'améliorer la qualité de nos catalogues, veuillez nous signaler toutes anomalies que vous pourriez constater au N° de Fax suivant : 33 (0)1 47 48 46 01

GB

All our products and their chemical components have been approved by our test laboratories and medical team, confirming that they do not exert a negative environmental impact. All this information is contained in related Coshh sheets. All users handling hazardous products must be able to access this information.

It can be found on the INTERNET : <http://www.quickfds.com>.

 In order to improve the quality of our catalogues, please let us know of any errors you find on the following Fax N°: 33 (0)1 47 48 46 01

E

Nuestros productos pasan por la aprobación de nuestro Laboratorio y de nuestro Servicio Médico sobre las composiciones químicas y su naturaleza, preservando al hombre y al medio ambiente. Todas estas informaciones se encuentran contenidas en las fichas de Datos de Seguridad. Todo utilizador en contacto con productos peligrosos debe tener conocimiento de ellas.

Vds. pueden consultarlas en INTERNET : <http://www.quickfds.com>.

 Con el fin de mejorar la calidad de nuestros catálogos rogamos nos indiquen cualquier anomalía que detecten al N° de Fax siguiente : 33 (0)1 47 48 46 01

P

Os nossos produtos estão aprovados pelo nosso Laboratório e Serviços de Saúde quanto à sua composição química, defesa do homem e do ambiente. Todas estas informações estão nas fichas de dados de segurança. Todo o utilizador destes produtos deverá ter conhecimento.

Podem ser consultados na INTERNET : <http://www.quickfds.com>.

 Para melhorar a qualidade dos nossos catálogos, é favor assinalar todas as anomalias encontradas pelo N° de Fax seguinte : 33 (0)1 47 48 46 01

D

Unsere produkte unterliegen der freigabe durch unser Labor und unseres "medizinischen service" bezüglich ihrer chemischen zusammensetzung und ihrer umweltverträglichen eigenschaften. Alle informationen sind in den sicherheitsdatenblättern enthalten.

Jedem anwender dieser gefahrenstoffe müssen diese zugänglich sein.

Abfrage im INTERNET möglich : <http://www.quickfds.com>.

 Zur qualitätsverbesserung unserer kataloge meldensie bei der feststellung von unklarheiten diese bitte per telefax an folgende nummer : 33 (0)1 47 48 46 01

I

I nostri prodotti ricoprono un'approvazione obbligatoria del nostro laboratorio e del nostro servizio medico sulle composizioni chimiche e sulla loro natura a preservare l'uomo e il suo ambiente naturale. Tutte queste informazioni sono presenti nelle schede di sicurezza. Tutte le persone in contatto con dei prodotti pericolosi devono poter prenderne conoscenza.

Potete consultarli su INTERNET : <http://www.quickfds.com>.

 Per poter migliorare la qualità dei nostri cataloghi, vi preghiamo di segnalare eventuali anomalie riscontrate al seguente N° di Fax : 33 (0)1 47 48 46 01

NL

De chemische samenstelling en de eventuele effecten op mens en natuur van onze producten zijn door onze laboratoria en Medische Dienst goedgekeurd. Al deze informatie staan vermeld op veiligheidskaarten. Elke gebruiker die in aanraking komt met gevaarlijke stoffen moet hiervan kennis kunnen nemen

U kunt hiervoor INTERNET raadplegen : <http://www.quickfds.com>.

 Om de kwaliteit van onze catalogussen te verbeteren, verzoeken wij u om de door u geconstateerde afwijkingen te melden op het volgende Faxnummer : 33 (0)1 47 48 46 01

ECLAIRAGE
LIGHTING - ILUMINACION - ILUMINAÇÃO
BELEUCHTUNG - ILLUMINAZIONE - VERLICHTING

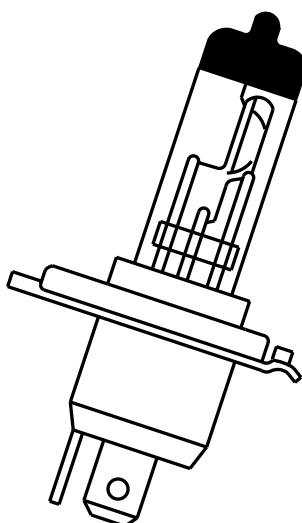

6216 41	C.E	6216 33	H3
6216 47	H1	6216 30	H4
6216 39	H2	6216 56	H7

R2 Visio CE	R2 CE	H1 Spot 65W	H2 65W	H3 65W	H4 60/65W	H7 65W	P21W (21W)	PY21W (21W)	P21/4W P21/5W	R5W 6W
6371 46 "Visio" 9466 02 "Haloroad"	6216 41 * 6216 42 **	6216 47	6216 39	6216 33	6216 30 * 6216 43 ** 9466 03 "Allseason"	6216 56	6216 27	6216 31	6216 52 (4W) 6216 28 (5W)	6216 26
R10W (10W)	W5W 6W	WY5W 6W	T2W (2W)	T4W (4W)	T5W 6W	T10/2W T10/3W	T10 Xénon (6W)	Diode	C3W/C4W C5W/C7W	W1,2 (1,2W)
6216 40	6216 32	6371 49	6216 36	6216 25	6216 44	6216 35 (2W) 6216 34 (3W)	6216 50	6371 40	6216 46 (3W) 6216 36 (4W) 6216 29 (5W) 6216 37 (7W)	6216 40

* BLANCHE - WHITE - BLANCA - BRANCA - WEISS - BIANCO - WIT

** JAUNE - YELLOW - AMARILLO - AMARELO - GELB - GIALLO - GEEL



Feux de croisement
Dipped beams
Luzes de crube
Faisés médios
Abblendlicht
Anabbagliante
Gedimd/grootlicht



Indicateur de direction gauche
Left indicator
Indicador de direccin izquierda
Blinker links
Indicatore di direzione sinistro
Krippellicht links



Feux de stop
Brake lights
Luzes de stop
Faisés de stop
Stopleuchte
Farnale stop
Remlicht



Eclairage plaque de police
Numberplate lighting
Luz placa matricula
Luz da chapa de matricula
Kennzeichnerleuchte
Illuminazione targa
Kentekerplaatverlichting



Lecteur de carte
Map reading lamp
Lector de mapas
Lector de mapas
Kaartleeslampe
Lettore carte
Kaartleeslamp



Indicateur de direction droit
Right indicator
Indicador de direccin derecha
Blinker rechts
Indicatore di direzione destro
Krippellicht rechts



Combiné
Instrument panel
Tablero de abordo
Combinado
Aimturien
Quadro instrument
Instrumentenpaneel



Feux de position
Side lights
Luzes de posicin
Faisés mínimos
Standlicht
Luz de posicione
Parkseilicht



Lève-vitre
Electric window
Elevavinas
Levante vidros
Schalbenheber
Alzavetro
Ruitmechanisme



Feux arrière de brouillard
Rear foglights
Luzes traseras de niebla
Faisés traseiros de nevoeiro
Nebelrückleuchte
Farnale nebbia posteriore
Mistlampen achter



Feux antibrouillard avant
Front fog lights
Luzes antineblia delanteras
Faisés de nevoeiro da frente
Nebelleuchte vorn
Faro antinebbia anteriore
Breedstralers vóór



Plafonnier
Interior lamp
Luz de techo
Luz de teto interior
Innenleuchte
Plafoniera
Binnenverlichting



Feux de route
Main beam
Luzes de carretera
Faisés de longo alcance
Fernlicht
Proiettile
Grootlicht



Eclairage de coffre
Boot light
Luz de maletero
Iluminação da mala
Kofferraumleuchte
Illuminazione baule
Kofferverlichting



Feux de recul
Reversing lights
Luzes de marcha atrás
Faisés de marcha atrás
Rückfahrleuchte
Farnale retromarcia
Achteruitrijlampen



Feux stop supplémentaire
Additional braking light
Luzes de stop suplementarias
Fard stop suplementar
Zusatzstopleuchte
Farnale stop supplementare
Derde remlicht











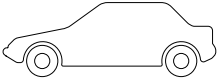







- TRI PAR MARQUES
- LISTED BY MANUFACTURER
- CLASIFICADO POR MARCAS
- TRI POR MARCAS
- GEORDNET NACH MARKEN
- ORDINE ALFABETICO PER MARCHE
- OP MERK VOLGORDE

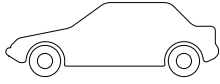







Pour :

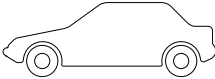



For/Para/Für/Per/Voor









ALFA ROMEO	5
AUDI	5
AUSTIN	6
BMW	6
CHRYSLER	6
DAEWOO	6
DAIHATSU	7
FIAT	7
FORD	8
HONDA	8
HYUNDAI	9
ISUZU	9
JAGUAR	9
KIA	9
LADA	10
LANCIA	10
LAND ROVER	10
LEXUS	10
MAZDA	10
MERCEDES	11
MITSUBISHI	12
NISSAN	12
OPEL	13
PEUGEOT	14
PORSCHE	14
RENAULT	14
ROVER	15
SAAB	16
SEAT	16
SKODA	16
SUBARU	16
SUZUKI	17
TALBOT	17
TOYOTA	17
VOLKSWAGEN	18
VOLVO	19

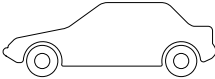







							
Pour ALFA ROMEO							
ALFA 33	→ 02/90	H4	6216 30	H4	6216 30		
ALFA 33	03/90 →	H4	6216 30	H4	6216 30	H3	6216 33
ALFA 33 Sportwagen	90 → 95	H4	6216 30	H4	6216 30	H3	6216 33
ALFA 75	85 →	H4	6216 30	H4	6216 30		
ALFA 90	85 → 87	H4	6216 30	H4	6216 30	H2	6213 39
ALFA 145/146	94 →	H4	6216 30	H4	6216 30		
ALFA 145/146	96 →	H1	6216 47	H1	6216 47	H1	6216 47
ALFA 155	92 →	H1	6216 47	H1	6216 47	H1	6216 47
ALFA 156		H7	6216 56	H1	6216 47	H1	6216 47
ALFA 164	87 →	H4	6216 30	H4	6216 30		
ALFA 166		H3	6216 33	H3	6216 33		
ALFASUD Sprint	78 → 89	H1	6216 47	H1	6216 47		
ALFETTA Quadrifoglio	83 → 86	H1	6216 47	H1	6216 47		
ALFETTA GT/GTV 2L	→ 81	H1	6216 47	H1	6216 47		
ALFETTA Guilleta	78 → 86	H4	6216 30	H4	6216 30		
GTV 2L/ GTV6 2,5L	81 → 88	H1	6216 47	H1	6216 47		
GTV 6 TB		H3	6216 33	H3	6216 33		
SPIDER		H3	6216 33	H3	6216 33		
ALFASUD/Super/Ti	78 → 89	H1	6216 47	H1	6216 47		
ARNA	83 → 86	H4	6216 30	H4	6216 30		
ALFA 6	84 → 86	H4	6216 30	H4	6216 30		
Pour AUDI							
A3		H7/H4	6216 56 6216 30	H1/H4	6216 47/ 6216 30	H3	6216 33
A4		H7/H4	6216 56 6216 30	H1/H4	6216 47/ 6216 30	H1	6216 47
A6		H1	6216 47	H1	6216 47	H3	6216 33
A8		H1/MPXL	6216 47	H3	6216 33	H3	6216 33
COUPE / QUATTRO	88 →	H4	6216 30	H1	6216 47	H3	6216 33
COUPE	89 →	H4	6216 30	H1	6216 47	H3	6216 33
80 I	72 → 76	H4/H1	6216 30 6216 47	H1	6216 47		
80 II	76 → 78	H4	6216 30	H1	6216 47	H3	6216 33
80 III	78 → 86	H4	6216 30	H4	6216 30	H3	6216 33
80 IV	86 → 91	H4	6216 30	H4	6216 30	H3	6216 33
80 V	91 →	H4	6216 30	H1	6216 47	H3	6216 33
90 / 90 QUATTRO	→ 87	H4	6216 30	H1	6216 47	H3	6216 33
90 / 90 QUATTRO	87 → 91	H4	6216 30	H1	6216 47	H3	6216 33
100	78 → 82	H4	6216 30	H4	6216 30	H3	6216 33
100	82 → 12/90	H4	6216 30	H4	6216 30	H3	6216 33
100	01/91 →	H4	6216 30	H4	6216 30	H3	6216 33
200	→ 82	H4	6216 30	H1	6216 47	H3	6216 33
200	82 →	H4	6216 30	H3	6216 33	H3	6216 33
COUPE QUATTRO	79 → 87	H4	6216 30	H1	6216 47	H3	6216 33
COUPE QUATTRO	88 →	H4	6216 30	H1	6216 47	H1	6216 47

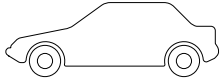





							
Pour AUDI (suite)							
V8	89 →	H4	6216 30	H3	6216 33	H3	6216 33
S 4		H7	6216 56	H7	6216 56	H7	6216 56
S 8				H3	6216 33		
Pour AUSTIN							
MAESTRO / MONTEGO	83 → 85	H4	6216 30	H4	6216 30		
MAESTRO / MONTEGO	86 →	H4	6216 30	H4	6216 30		
METRO	80 → 85	H4	6216 30	H4	6216 30		
METRO	86 → 90	R2	6216 41	R2	6216 41		
METRO (iode H4)	86 → 90	H4	6216 30	H4	6216 30		
MINI	80 →	R2	6216 41	R2	6216 41		
MONTEGO Kombi	83 → 85	H4	6216 30	H4	6216 30		
MONTEGO Kombi	86 →	H4	6216 30	H4	6216 30		
Pour BMW							
SERIE 3 (E21)	75 → 84	H4	6216 30	H4	6216 30		
SERIE 3 (E30)	82 → 92	H1 Spot	6216 47	H1 Spot	6216 47	H3	6216 33
SERIE 3 (E36)	90 → 95	H1 Spot	6216 47	H1 Spot	6216 47	H1	6216 47
SERIE 3 (E36)	95 → 98	H7	6216 56	H7	6216 56	H1	6216 47
SERIE 5 (E28)	80 → 90	H4	6216 30	H1 Spot	6216 47	H3	6216 33
SERIE 5 (E34)	88 → 95	H1 Spot	6216 47	H1 Spot	6216 47	H1	6216 47
SERIE 5 (E39)	95 →	H7	6216 56	H3	6216 33	H7	6216 56
SERIE 6 (E24)	76 → 90	H1	6216 47	H1	6216 47	H3	6216 33
SERIE 7 (E23)	77 → 86	H4	6216 30	H1 Spot	6216 47	H3	6216 33
SERIE 7 (E32)	86 → 94	H1 Spot	6216 47	H1 Spot	6216 47	H1	6216 47
SERIE 7 (E38)	94 →	H7	6216 56	H1 Spot	6216 47	H3	6216 33
850i	89 →	H1	6216 47	H1	6216 47	H1	6216 47
Z3		H7	6216 56	H3	6216 33	H7	6216 56
SERIE 3 Compact		H4	6216 30	H3	6216 33	H1	6216 47
Pour CHRYSLER							
CHEROKEE		H4	6216 30	H4	6216 30		
VOYAGER		H4	6216 30	H4	6216 30		
WRANGLER	83 →	H4	6216 30	H4	6216 30		
NEON		H4	6216 30				
STRATUS CAB		H2	6216 39	H2	6216 39	H3	6216 33
VIPER		H1	6216 47	H1	6216 47	H3	6216 33
Pour DAEWOO							
ESPERO	93 → 96	H1	6216 47	H1	6216 47		
LANOS	80	H4	6216 30	H4	6216 30		
LEGANZA	93 → 96	H1	6216 47	H3	6216 33		
MATIZ	89 → 96	H4	6216 30	H4	6216 30		
NEXIA	89 → 96	H4	6216 30	H4	6216 30		
NUBIRA	87	H4	6216 30	H4	6216 30		



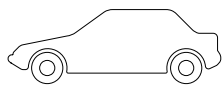



							
Pour DAIHATSU							
MIRA	93 → 96	H4	6216 30	H4	6216 30		
CUORE	80	H4	6216 30	H4	6216 30		
CHARADE	83 → 93	R2	6216 41	R2	6216 41		
CHARADE	93 → 96	H4	6216 30	H4	6216 30		
CHARMANT	82 → 86	R2	6216 41	R2	6216 41		
APPLAUSE	89 → 96	H4	6216 30	H4	6216 30		
F20/25/50/55/ROCHY	79 → 84	R2	6216 41	R2	6216 41		
ROCKY	87	H4	6216 30	H4	6216 30		
R80/85	84 → 91	R2	6216 41	R2	6216 41		
Pour FIAT							
126 FIORINO	84 → 92	R2	6216 41	R2	6216 41		
127 FIORINO	79 → 88	H4	6216 30	H4	6216 30		
131 MIRAFIORI	80 → 84	H1	6216 47	H1	6216 47		
900 TIE/283/242	79 → 84	R2	6216 41	R2	6216 41		
ARGENTA 83-86 X1 73-89		H4	6216 30	H4	6216 30		
BARCETTA	→ 95	H1	6216 47	H3	6216 33		
BRAVO / BRAVA	95 →	H1	6216 47	H1	6216 47		
BRAVO / BRAVA	97 →	H1	6216 47	H1	6216 47		
CINQUECENTO	94 →	H4	6216 30	H4	6216 30		
SEICENTO		H4	6216 30	H4	6216 30	H3	6216 33
CROMA	86 →	H4	6216 30	H4	6216 30	H3	6216 33
DUCATO	→ 82	R2	6216 41	R2	6216 41		
DUCATO	82 → 94	R2	6216 41	R2	6216 41		
DUCATO	94 →	H4	6216 30	H4	6216 30		
FIORINO	88 → 92	H4	6216 30	H4	6216 30		
FIORINO RS	93 → 93	H4	6216 30	H4	6216 30		
MAREA		H1	6216 47	H1	6216 47	H1Spot/H3	6216 47
MULTIPLIA		H4	6216 30	H4	6216 30	H1	6216 47
PALIO WEEK-END		H4	6216 30	H4	6216 30	H3	6216 33
PANDA	79 →	R2	6216 41	R2	6216 41		
PUNTO (Plastic Orange)	→ 93	H4	6216 30	H4	6216 30		
PUNTO (Plastic White)	→ 93	H4	6216 30	H4	6216 30		
PUNTO	94 →	H4	6216 30	H4	6216 30	H3	6216 33
PUNTO ELX	94 →	H1	6216 47	H1	6216 47	H3	6216 33
REGATA	83 → 91	H4	6216 30	H4	6216 30		
RITMO	83 → 89	H4	6216 30	H1	6216 47	H1	6216 47
TIPO / TEMPRA	88 → 95	H4	6216 30	H4	6216 30		
ULYSSE		H4	6216 30	H4	6216 30		
ULYSSE	94 →	H1	6216 47	H1	6216 47	H3	6216 33
UNO	82 → 09/89	H4	6216 30	H4	6216 30		
UNO	10/89 →	H4	6216 30	H4	6216 30	H3	6216 33
COUPE		H4	6216 30	H4	6216 30	H1	6216 47
BARCETTA		H1	6216 47	H1	6216 47	H3	6216 33



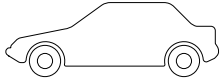





							
Pour FORD							
CAPRI	78 → 88	H1	6216 47	H1	6216 47		
ESCORT	74 → 80	H4	6216 30	H4	6216 30	H3	6216 33
ESCORT Turnier	75 → 81	H4	6216 30	H4	6216 30		
ESCORT III	80 → 85	H4	6216 30	H4	6216 30		
ESCORT	85 → 90	H4	6216 30	H4	6216 30		
ESCORT V	90 → 92	H4	6216 30	H4	6216 30	H3	6216 33
ESCORT VI	94	H4	6216 30	H4	6216 30		
FIESTA I	76 → 83	H4	6216 30	H4	6216 30		
FIESTA II	83 → 89	H4	6216 30	H4	6216 30		
FIESTA III	89 → 95	H4	6216 30	H4	6216 30	H3	6216 33
FIESTA IV	→ 96	H4	6216 30	H4	6216 30	H3	6216 33
FIESTA	96 →	H7	6216 56	H1	6216 47	H1	6216 47
FOCUS		H4	6216 30	H4	6216 30	H1	6216 47
GALAXY		H4	6216 30	H4	6216 30	H1	6216 47
GRANADA	72 → 85	H4	6216 30	H4	6216 30	H3	6216 33
KA	96 →	H7	6216 56	H1	6216 47	H1	6216 47
MAVERICK	93 → 98	H4	6216 30	H4	6216 30	H1	6216 47
MAVERICK	98 →	H4	6216 30	H4	6216 30	H1	6216 47
MONDEO I	93 → 96	H4	6216 30	H4	6216 30	H1	6216 47
MONDEO II	96 →	H7	6216 56	H7	6216 56	H2	6213 39
ORION I	83 → 86	H4	6216 30	H4	6216 30		
ORION II	86 → 90	H4	6216 30	H4	6216 30		
ORION III	90 → 93	H4	6216 30	H4	6216 30		
PROBE		H4	6216 30	H4	6216 30	H3	6216 33
PUMA		H3	6216 33	H3	6216 33		
SCORPIO I	85 → 94	H4	6216 30	H1	6216 47	H3	6216 33
SCORPIO II	94 →	H4	6216 30	H3	6216 33	H3	6216 33
SIERRA	82 → 86	H4	6216 30	H4	6216 30	H3	6216 33
SIERRA	87 → 93	H4	6216 30	H3	6216 33	H3	6216 33
SIERRA Turnier	87 → 93>	H4	6216 30	H3	6216 33	H3	6216 33
GALAXY	95 →	H4	6216 30	H4	6216 30		
GALAXY	97 →	H4	6216 30	H4	6216 30	H1	6216 47
P100	81 → 88	H4	6216 30	H4	6216 30		
P100	88 → 95	H4	6216 30	H4	6216 30		
TRANSIT	84 → 94	H4	6216 30	H4	6216 30		
TRANSIT	95 →	H4	6216 30	H4	6216 30		
Pour HONDA							
ACCORD	77 → 89	H1	6216 47	H1	6216 47		
ACCORD	93 → 96	H4	6216 30	H4	6216 30		
ACCORD	96	H1	6216 47	H1	6216 47	H1	6216 47
BALLADE	86 → 89	H4	6216 30	H4	6216 30		
CIVIC/CRX	11/91 →	H4	6216 30	H4	6216 30		
CIVIC/CRX	10/91	H4	6216 30	H4	6216 30		
CONCERTO		H7	6216 56	H7	6216 56	H1	6216 47

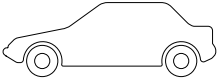







							
Pour HONDA (suite)							
INTEGRA	86 →	H4	6216 30	H4	6216 30		
INTEGRA	97 →	H3	6216 33	H4	6216 30		
JAZZ	83 → 86	H4	6216 30	H4	6216 30		
LEGEND	87 → 91	H4	6216 30	H4	6216 30		
LEGEND	91 →	H4	6216 30	H4	6216 30		
LEGEND	96 →	H4	6216 30	H4	6216 30		
LEGEND Coupé	91 →	H4	6216 30	H4	6216 30		
NSX		H3	6216 33	H3	6216 33	H3	6216 33
CR-V		H4	6216 30	H4	6216 30		
PRELUDE	83 → 92	H4	6216 30	H4	6216 30	H3	6216 33
PRELUDE		H4	6216 30	H4	6216 30	H3	6216 33
SHUTTLE	96	H4	6216 30	H4	6216 30		
Pour HYUNDAI							
PONY	85 → 90	H4	6216 30	H4	6216 30		
PONY	91 →	H4	6216 30	H4	6216 30		
PONY	96 →	H4	6216 30	H4	6216 30		
ATOS		H4	6216 30	H4	6216 30		
ACCENT	94 →	H4	6216 30	H4	6216 30		
LANTRA	93 → 95	H4	6216 30	H4	6216 30		
LANTRA	96 →	H4	6216 30	H4	6216 30		
SONATA	89 → 93	H4	6216 30	H4	6216 30		
SONATA	93 →	H4	6216 30	H4	6216 30		
SONATA	97 →	H4	6216 30	H4	6216 30		
S Coupé	93 →	H4	6216 30	H4	6216 30		
SATELLITE		H4	6216 30	H4	6216 30		
H100		H4	6216 30	H4	6216 30		
Pour ISUZU							
TROOPER	86 → 91	H4	6216 30	H4	6216 30	H3	6216 33
TROOPER	92 →	H4	6216 30	H4	6216 30	H4	6216 30
Pour JAGUAR							
XJ6	86 →	H4	6216 30	H4	6216 30	H2	6213 39
XJ6/12/SOVEREIGN	81 → 85	H4	6216 30	H1	6216 47	H1	6216 47
SOVEREIGN	96 →	H4	6216 30	H4	6216 30	H1	6216 47
XJS	78 → 83	H1	6216 47	H1	6216 47	H1	6216 47
XJS	84 →	H4	6216 30	H4	6216 30	H1	6216 47
Pour KIA							
PRIDE	91 → 94	H4	6216 30	H4	6216 30		
MENTOR	94 →	H4	6216 30	H4	6216 30		
SEPHIA		H4	6216 30	H4	6216 30		
SPORTAGE		H4	6216 30	H4	6216 30		
CLARUS		H4	6216 30	H4	6216 30		
PRIDE	94 →	H4	6216 30	H4	6216 30		

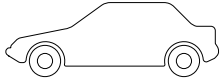







							
Pour KIA (suite)							
SHUMA		H1	6216 47	H1	6216 47		
Pour LADA							
KALINKA		H4	6216 30	H4	6216 30		
NIVA	80 →	H4	6216 30	H4	6216 30		
NIVA 1700	96 →	H4	6216 30	H4	6216 30		
RIVA	80 →	H4	6216 30	H4	6216 30		
SAGONA		H4	6216 30	H4	6216 30		
SAGONA	96 →	H4	6216 30	H4	6216 30		
SAMARA	80 →	H4	6216 30	H4	6216 30		
SAMARA	96 →	H4	6216 30	H4	6216 30		
Pour LANCIA							
BETA	76 → 85	H1	6216 47	H1	6216 47	H3	6216 33
BETA HPE/Spider	76 → 85	H1	6216 47	H1	6216 47	H3	6216 33
DEDRA	89 →	H4	6216 30	H4	6216 30	H3	6216 33
DELTA	80	H4	6216 30	H4	6216 30	H3	6216 33
DELTA	86 → 92	H4	6216 30	H4	6216 30	H3	6216 33
DELTA	93 →	H4	6216 30	H4	6216 30	H3	6216 33
GAMMA	76 → 85	H1	6216 47	H1	6216 47	H3	6216 33
GAMMA Coupé	76 → 85	H1	6216 47	H1	6216 47	H3	6216 33
KAPPA	94	H7	6216 56	H7	6216 56	H3	6216 33
IPSILO		H4	6216 30	H4	6216 30		
PRISMA	83 → 86	H4	6216 30	H4	6216 30	H3	6216 33
THEMA	84 → 91	H4	6216 30	H4	6216 30	H3	6216 33
THEMA	92 →	H4	6216 30	H4	6216 30	H3	6216 33
Y10	85 → 91	R2	6216 41	R2	6216 41		
Y10	92 →	R2	6216 41	R2	6216 41		
ZETA	95 →	H4	6216 30	H4	6216 30	H3	6216 33
Pour LAND ROVER							
90/110 Defender	83 → 96	H4	6216 30	H4	6216 30		
DISCOVERY	90 → 96	H4	6216 30	H4	6216 30		
RANGE ROVER	80 → 94	H4	6216 30	H4	6216 30		
RANGE ROVER Vogue	82 → 94	H4	6216 30	H4	6216 30	H3	6216 33
RANGE ROVER	94 →	H4	6216 30	H4	6216 30	H4	6216 30
Pour LEXUS							
LS 400	90 →	H4	6216 30	H4	6216 30	H3	6216 33
Pour MAZDA							
121 I	87 → 90	H4	6216 30	H4	6216 30		
121 II	90 → 96	H4	6216 30	H4	6216 30		
121 III	96 →	H7	6216 56	H1	6216 47		
323 BD	81 → 85	H4	6216 30	H4	6216 30		
323 BF	85 → 91	H4	6216 30	H4	6216 30		

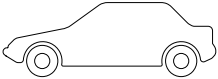



							
Pour MAZDA (suite)							
323 BG	89 → 94	H4	6216 30	H4	6216 30		
323 F BA	94 →	H4	6216 30	H4	6216 30		
626 II GC	82 → 87	H4	6216 30	H4	6216 30		
626 III	87 → 92	H4	6216 30	H4	6216 30		
626 STH GC	82 → 87	H4	6216 30	H4	6216 30		
626	87 → 96	H3	6216 33	H1	6216 47	H1	6216 47
626	96 →	H7	6216 56	H1	6216 47	H1	6216 47
929 II	82 → 87	H4	6216 30	H4	6216 30		
MX3	91 → 97	H4	6216 30	H4	6216 30	H3	6216 33
MX3	97 →	H4	6216 30	H4	6216 30	H3	6216 33
MX5	93 →	H4	6216 30	H3	6216 33		
MX6	92 → 96	H1	6216 47	H1	6216 47	H1	6216 47
RX7 I	79 → 84	H4	6216 30	H4	6216 30		
RX7 II	85 → 91	H4	6216 30	H4	6216 30		
RX7 III	92 → 93	H4	6216 30	H4	6216 30		
XEDOS 6	92 → 96	H4	6216 30	H4	6216 30		
XEDOS 6	96 →	H1	6216 47	H3	6216 33		
XEDOS 9	→ 96	H4	6216 30	H4	6216 30		
XEDOS 9	96 →	H4	6216 30	H1	6216 47		
Pour MERCEDES							
180 Klasse C	94 →	H1	6216 47	H1	6216 47	H3	6216 33
190E/200E/200TE	79 →	H4	6216 30	H4	6216 30	H3	6216 33
W115 (200 D-230.4"/8")	68 → 77	R2	6216 41	R2	6216 41	H3	6216 33
W114 (230.6-280 E"/8")	68 → 76	R2	6216 41	R2	6216 41	H3	6216 33
W114 Coupé (250 C-280 CE"/8")	69 → 77	R2	6216 41	R2	6216 41	H3	6216 33
W123 (200-280 E)/S123 (200T-280 TE)	76 → 85	H4	6216 30	H4	6216 30	H3	6216 33
W124 (200-500 E)	83 → 93	H4	6216 30	H4	6216 30	H3	6216 33
W124 E-Klasse	93 → 95	H4	6216 30	H4	6216 30	H3	6216 33
R 124 Cabrio		H4	6216 30	H4	6216 30	H3	6216 33
W461/463 Plane G-Klasse	79 →	H4	6216 30	H4	6216 30	H3	6216 33
280S/500E/560SEC	79 →	H4	6216 30	H4	6216 30	H3	6216 33
280SL/500SLC	80 → 90	H4	6216 30	H4	6216 30	H3	6216 33
300SE/600SL	91 →	H1	6216 47	H1	6216 47	H3	6216 33
300SL/500SL	89 →	H4	6216 30	H4	6216 30	H1	6216 47
730 D		H3	6216 33	H3	6216 33		
E-Klasse	93 → 95	H4	6216 30	H4	6216 30	H3	6216 33
E-Klasse	95	H7	6216 56	H7	6216 56	H3	6216 33
R 170 SLK	96 →	H7	6216 56	H7	6216 56	H3	6216 33
S-Klasse		H7	6216 56	H7	6216 56	H3	6216 33
A-Klasse		H7	6216 56	H7	6216 56	H3	6216 33
ML- 320		H7	6216 56	H1	6216 47	H3	6216 33
VITO		H4	6216 30	H4	6216 30		









							
Pour MERCEDES (suite)							
V-Klasse		H4	6216 30	H4	6216 30	H3	6216 33
CLK		H7	6216 56	H7	6216 56	H3	6216 33
Pour MITSUBISHI							
1200/1500/1600 Turbo	84 → 88	H4	6216 30	H4	6216 30		
3000 GT	93 → 95	H4	6216 30	H4	6216 30		
3000 GT	95 →	H4	6216 30	H3	6216 33		
CARISMA	95 →	H4	6216 30	H4	6216 30		
COLT / LANCER	84 → 88	H4	6216 30	H4	6216 30		
COLT / LANCER	88 → 92	H4	6216 30	H4	6216 30	H1	6216 47
COLT	92 →	H4	6216 30	H4	6216 30	H1	6216 47
ECLIPSE	91 →	H4	6216 30	H4	6216 30	H3	6216 33
GALANT III	84 → 88	H4	6216 30	H4	6216 30		
GALANT IV	88 → 92	H4	6216 30	H4	6216 30		
GALANT V	92 → 96	H4	6216 30	H4	6216 30	H1	6216 47
L200	86 →	H4	6216 30	H4	6216 30		
L300	86 →	H4	6216 30	H4	6216 30		
LANCER / KOMBI V	92 → 96	H4	6216 30	H4	6216 30	H1	6216 47
LANCER / KOMBI	96 →	H4	6216 30	H4	6216 30	H1	6216 47
PAJERO	83 → 85	H4	6216 30	H4	6216 30		
PAJERO	86 → 91	H4	6216 30	H4	6216 30		
PAJERO	91 →	H4	6216 30	H4	6216 30		
SIGMA / KOMBI	90 → 96	H4	6216 30	H4	6216 30	H1	6216 47
SPACE GEAR	95 →	H4	6216 30	H4	6216 30		
SPACE RUNNER	91 →	H4	6216 30	H4	6216 30		
SPACE WAGON	84 → 91	H4	6216 30	H4	6216 30		
SPACE WAGON	91 →	H4	6216 30	H4	6216 30		
Pour NISSAN							
ALMERA	95 →	H4	6216 30	H4	6216 30	H2	6213 39
100NX	91 →	H4	6216 30	H4	6216 30	H3	6216 33
200SX	81 →	H4	6216 30	H4	6216 30	H3	6216 33
300C	84 → 88	R2	6216 41	R2	6216 41		
300ZX (Z31)	→ 90	H4	6216 30	H4	6216 30		
300ZX (Z32)	90 →	H3	6216 33	H3	6216 33		
BLUEBIRD	80 → 90	H4	6216 30	H4	6216 30		
CABSTAR	82 →	H4	6216 30	H4	6216 30		
CHERRY (N12)	82 → 86	H4	6216 30	H4	6216 30		
LAUREL	85 → 89	H4	6216 30	H4	6216 30		
MAXIMA	88 →	H4	6216 30	H4	6216 30		
MAXIMA QX	95	H4	6216 30	H4	6216 30	H3	6216 33
MICRA	83 → 85	H4	6216 30	H4	6216 30		
MICRA	85 →	H4	6216 30	H4	6216 30		
MICRA	91 →	H4	6216 30	H4	6216 30		
PATROL	79 → 93	H4	6216 30	H4	6216 30		

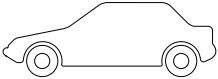





							
Pour NISSAN (suite)							
PATROL	93 →	H4	6216 30	H4	6216 30	H3	6216 33
PRAIRIE	83 → 89	H4	6216 30	H4	6216 30		
PRIMERA		H4	6216 30	H4	6216 30	H3	6216 33
PRIMERA	90 →	H4	6216 30	H4	6216 30	H3	6216 33
QX	95 →	H4	6216 30	H4	6216 30	H3	6216 33
SILVIA	84 → 88	H4	6216 30	H4	6216 30		
SUNNY	82 → 87	H4	6216 30	H4	6216 30		
SUNNY	87 → 91	H4	6216 30	H4	6216 30	H3	6216 33
SUNNY	90 → 95	H4	6216 30	H4	6216 30	H3	6216 33
TERRANO	86 → 96	H4	6216 30	H4	6216 30		
TERRANO II	93 → 96	H4	6216 30	H4	6216 30	H1	6216 47
URVAN E24	87 →	H4	6216 30	H4	6216 30		
VANETTE	85 →	H4	6216 30	H4	6216 30		
Pour OPEL							
ASCONA-C CC	81 → 88	H4	6216 30	H4	6216 30	H3	6216 33
ASTRA / CARAVAN	91 → 97	H4	6216 30	H4	6216 30	H1	6216 47
ASTRA-F	91 → 97	H4	6216 30	H4	6216 30	H1	6216 47
ASTRA	97 →	H3	6216 33	H3	6216 33		
CALIBRA-A	90 → 97	H1 Spot	6216 47	H1 Spot	6216 47	H3	6216 33
CORSA-A CC	82 → 93	H4	6216 30	H4	6216 30		
CORSA-B	93 →	H4	6216 30	H4	6216 30	H3	6216 33
FRONTERA	92 →	H1	6216 47	H2	6213 39	H4	6216 30
KADETT-D	79 → 84	H4	6216 30	H4	6216 30		
KADETT-E	84 → 91	H4	6216 30	H4	6216 30		
MANTA-B CC	75 → 88	H4	6216 30	H4	6216 30		
MONTEREY	94 → 96	H4	6216 30	H4	6216 30		
MONZA-A	78 → 86	H4	6216 30	H4	6216 30	H3	6216 33
OMEGA-A CARAVAN	86 → 94	H4	6216 30	H1 Spot	6216 47	H3	6216 33
OMEGA-A	86 → 94	H4	6216 30	H1 Spot	6216 47	H3	6216 33
OMEGA CARAVAN	86 →	H4	6216 30	H4	6216 30	H3	6216 33
OMEGA	86 →	H4	6216 30	H4	6216 30	H3	6216 33
OMEGA-B	94	H7	6216 56	H1	6216 47	H3	6216 33
OMEGA	98/5					H3	6216 33
REKORD-E	77 → 83	H4	6216 30	H4	6216 30		
REKORD-E	84 → 86	H4	6216 30	H4	6216 30		
REKORD CARAVAN	77 → 87	H4	6216 30	H4	6216 30		
SENATOR-B	88 → 93	H4	6216 30	H1	6216 47	H3	6216 33
SENATOR/MONZA	83 → 87	H4	6216 30	H4	6216 30	H3	6216 33
SENATOR-CD	84 → 87	H4	6216 30	H3	6216 33	H3	6216 33
TIGRA	94 →	H1	6216 47	H1	6216 47		
VECTRA-A	88 → 95	H4	6216 30	H4	6216 30	H3	6216 33
VECTRA	95 →	H7	6216 56	H1	6216 47	H3	6216 33

							
Pour PEUGEOT							
104	72 → 83	R2	6216 41	R2	6216 41		
104	83 → 88	H4	6216 30	H4	6216 30		
106	91 → 96	H4	6216 30	H4	6216 30	H3	6216 33
205 / L GL GLD GR GRD XE XA XL	83 → 87	R2	6216 41	R2	6216 41		
206		H4	6216 30	H4	6216 30	H7	6216 56
305	78 → 88	H4	6216 30	H4	6216 30		
306 XN/XR	93 →	H4	6216 30	H4	6216 30		
306 XT/XSI	→ 95	H1 Spot	6216 47	H1 Spot	6216 47	H3	6216 33
306 XT/XSI	95 →	H7	6216 56	H7	6216 56	H3	6216 33
309	85 →	H4	6216 30	H4	6216 30	H1	6216 47
405 (- SRI STI MI 16)	87 →	H4	6216 30	H4	6216 30	H3	6216 33
405 SRI STI MI 16	87 →	H4	6216 30	H1 Spot	6216 47	H3	6216 33
405		H4	6216 30	H1	6216 47	H3	6216 33
406		H7	6216 56	H7	6216 56	H3	6216 33
504		H4	6216 30	H4	6216 30		
505	79 → 93	H4	6216 30	H4	6216 30		
604	77 → 87	H4	6216 30	H4	6216 30		
605	89 → 95	H1 Spot	6216 47	H1 Spot	6216 47	H3	6216 33
605	95 →	H7	6216 56	H7	6216 56	H1	6216 47
806	94 →	H1 Spot	6216 47	H1 Spot	6216 47	H3	6216 33
J5 / J7	82 → 95	R2	6216 41	R2	6216 41		
BOXER	94 →	H4	6216 30	H4	6216 30		
EXPERT		H4	6216 30	H4	6216 30		
PARTNER		H4	6216 30	H4	6216 30	H3	6216 33
Pour PORSCHE							
911	77 →	H4	6216 30	H4	6216 30	H3	6216 33
911 CARRERA/TURBO	93 → 96	H1	6216 47	H1	6216 47	H3	6216 33
911	93 → 96			H2	6213 39	H4	6216 30
924 / 944/ S2 TURBO		H4	6216 30	H3	6216 33	H3	6216 33
928	78 → 86	H4	6216 30	H4	6216 30	H3	6216 33
928/S4	87 →	H4	6216 30	H3	6216 33	H3	6216 33
968	92 →	H4	6216 30	H1	6216 47	H3	6216 33
993		H1	6216 47	H3	6216 33	H3	6216 33
993	95 →	H1	6216 47	H3	6216 33	H3	6216 33
Pour RENAULT							
CLIO RL	90 →	R2	6216 41	R2	6216 41	H3	6216 33
CLIO RN RT Baccara	90 →	H4	6216 30	H4	6216 30	H3	6216 33
CLIO S.Optic	98 →	H4	6216 30	H4	6216 30	H1	6216 47
CLIO D.Optic	98 →	H3	6216 33	H7	6216 56	H1	6216 47
EXPRESS	85 →	H4	6216 30	H4	6216 30	H1	6216 47
MASTER	81 → 95	R2	6216 41	R2	6216 41	H1	6216 47
MASTER	96 →	H4	6216 30	H4	6216 30	H1	6216 47
R4	62 → 93	R2	6216 41	R2	6216 41	H2	6213 39

							
Pour RENAULT (suite)							
R5	72 → 90	H4	6216 30	H4	6216 30	H2	6213 39
TWINGO	93 → 98	H4	6216 30	H4	6216 30		
TWINGO II	98 →	H4	6216 30	H4	6216 30	H3	6216 33
R9	81 → 88	H4	6216 30	H4	6216 30		
R9 Turbo GTL Broadway	08/85 → 88	H1	6216 47	H1	6216 47		
R11	83 → 86	H1	6216 47	H1	6216 47	H2	6213 39
R11 (- TXE Turbo)	08/86 → 88	H4	6216 30	H4	6216 30		
R11 TXE Turbo	08/86 → 88	H1	6216 47	H1	6216 47	H2	6213 39
R14	70 → 80	H4	6216 30	H4	6216 30		
ESPACE	84 → 91	H4	6216 30	H4	6216 30	H1	6216 47
ESPACE	92 → 96	H4	6216 30	H1	6216 47	H3	6216 33
ESPACE	96 →	H1Spot	6216 47	H1Spot	6216 47	H1 Spot	6216 47
FUEGO	80 → 85	H4	6216 30	H4	6216 30		
LAGUNA	93 → 96	H1 Spot	6216 47	H1Spot	6216 47	H1 Spot	6216 47
LAGUNA II	97	H7	6216 56	H7	6216 56	H1	6216 47
MASTER	81 → 95	R2	6216 41	R2	6216 41	H1	6216 47
R18	78 → 86	H4	6216 30	H4	6216 30		
R19 I	88 → 92	H4	6216 30	H4	6216 30	H3	6216 33
R19 II	88 → 92	H4	6216 30	H4	6216 30	H3	6216 33
R20 TL GTL	→ 80	R2	6216 41	R2	6216 41		
R20 TX GTD LS TS TD	→ 80	H4	6216 30	H4	6216 30		
R21	84 → 94	H4	6216 30	H4	6216 30	H3	6216 33
R21 Turbo		H4	6216 30	H3	6216 33	H2	6213 39
R25 GTS GTD TX	84 → 92	H4	6216 30	H4	6216 30		
R25 TI TXI V6 TURBO D DX	84 → 92	H4	6216 30	H1	6216 47		
SAFRANE	92 → 96	H1 Spot	6216 47	H1 Spot	6216 47	H1 Spot	6216 47
SAFRANE	97 → 98	H1 Spot	6216 47	H1 Spot	6216 47	H7	6216 56
SAFRANE RTE	98 →	H1 Spot	6216 47	H1 Spot	6216 47	H1	6216 47
SAFRANE RXE RXT Initiale	98 →					H1	6216 47
SCENIC		H4	6216 30	H4	6216 30		
SPIDER		H1 Spot	6216 47	H1 Spot	6216 47	H2	6213 39
MEGANE berline classic Scenic		H4	6216 30	H4	6216 30	H1	6216 47
MEGANE Coupé		H1 Spot	6216 47	H1 Spot	6216 47	H1spot	6216 47
KANGOO		H4	6216 30	H4	6216 30	H1	6216 47
Pour ROVER							
DEFENDER		H4	6216 30	H4	6216 30		
DISCOVER		H4	6216 30	H4	6216 30		
FREE LANDER		H4	6216 30	H4	6216 30		
LAND RANGE/ROVER	92 →	H4	6216 30	H4	6216 30		
100	90 →	H4	6216 30	H4	6216 30		
100	94 →	H4	6216 30	H4	6216 30		
200	86 → 90	H4	6216 30	H4	6216 30		
200	90 →	H4	6216 30	H4	6216 30		

							
Pour ROVER (suite)							
200	94 →	H4	6216 30	H4	6216 30	H1	6216 47
200	95 →	H7	6216 56	H7	6216 56	H1	6216 47
400	→ 95	H4	6216 30	H4	6216 30	H1	6216 47
400	95 →	H7	6216 56	H7	6216 56	H2	6213 39
420		H1	6216 47	H7	6216 56	H1	6216 47
600	94 →	H1	6216 47	H1	6216 47	H3	6216 33
800	86 → 92	H4	6216 30	H4	6216 30		
MG		H1	6216 47	H1	6216 47		
Pour SAAB							
9—3		H4	6216 30	H4	6216 30	H3	6216 33
9—5		H7	6216 56	H7	6216 56	H3	6216 33
900	84 → 87	H4	6216 30	H4	6216 30		
900	78 → 94	H4	6216 30	H4	6216 30		
9000 FLH	84 →	H4	6216 30	H4	6216 30		
9000 STH	85 →	H4	6216 30	H4	6216 30		
9000 CS	94 →	H1	6216 47	H1	6216 47		
Pour SEAT							
ALHAMBRA	96 →	H4	6216 30	H4	6216 30	H1	6216 47
ALHAMBRA	97 →	H4	6216 30	H4	6216 30	H1	6216 47
AROSA	97 →	H4	6216 30	H4	6216 30		
CORDOBA	→ 94	H4	6216 30	H4	6216 30	H3	6216 33
CORDOBA	94 →	H4	6216 30	H4	6216 30	H3	6216 33
IBIZA	85 →	H4	6216 30	H4	6216 30		
INCA	95 →	H4	6216 30	H4	6216 30		
MALAGA	85 →	H4	6216 30	H4	6216 30		
MARBELLA	88 →	H4	6216 30	H4	6216 30		
CORDOBA LR	97 →	H4	6216 30	H4	6216 30	H3	6216 33
CORDOBA HR	97 →	H1	6216 47	H1 Spot	6216 47	H3	6216 33
IBIZA LR	95 →	H4	6216 30	H4	6216 30		
IBIZA HR	95 →	H1	6216 47	H1 Spot	6216 47		
TERRA LR	97 →	R2	6216 41	R2	6216 41		
TERRA HR	97 →	H4	6216 30	H4	6216 30		
TOLEDO	91 → 97	H4	6216 30	H4	6216 30		
TOLEDO	97 →	H1	6216 47	H7	6216 56	H3	6216 33
Pour SKODA							
ESTELLE/RAPID	84 → 91	H4	6216 30	H4	6216 30		
FAVORIT	89 → 96	H4	6216 30	H4	6216 30	H3	6216 33
FAVORIT	97 →	H4	6216 30	H4	6216 30	H3	6216 33
FELICIA	97 →	H4	6216 30	H4	6216 30	H3	6216 33
PICK UP	97 →	H4	6216 30	H4	6216 30	H3	6216 33
Pour SUBARU							
JUSTY	84 → 88	H4	6216 30	H4	6216 30		

							
Pour SUBARU (suite)							
JUSTY	89 →	H4	6216 30	H4	6216 30		
L-Serie 1600/1800	79 → 84	H4	6216 30	H4	6216 30		
L-Serie 1600/1800	85 → 89	H4	6216 30	H4	6216 30		
E Serie	89 → 92	R2	6216 41	R2	6216 41		
E Serie/Libero	93 →	H4	6216 30	H4	6216 30		
LEGACY	90 →	H4	6216 30	H4	6216 30		
LEGACY Kombi	90 →	H4	6216 30	H4	6216 30		
IMPREZA	93 →	H4	6216 30	H4	6216 30		
SVX	92 →	H1	6216 47	H3	6216 33		
Pour SUZUKI							
SWIFT	84 → 89	H4	6216 30	H4	6216 30	H3	6216 33
SWIFT /VITARA	89	H4	6216 30	H4	6216 30	H3	6216 33
SWIFT SF	90 → 96	H4	6216 30	H4	6216 30		
SJ 410/413	82 →	R2	6216 41	R2	6216 41		
BALENO		H4	6216 30	H4	6216 30		
CARRY BIS	85	R2	6216 41	R2	6216 41		
CARRY AB	85	R2	6216 41	R2	6216 41		
ALTO	→ 85	R2	6216 41	R2	6216 41		
ALTO	85 →	R2	6216 41	R2	6216 41		
SUPERCARRY	86 → 96	R2	6216 41	R2	6216 41		
WAGON		H4	6216 30	H4	6216 30		
VITARA	96 →	H4	6216 30	H4	6216 30		
VITARA	98 →	H4	6216 30	H4	6216 30		
Pour TALBOT							
1307/1309/1510	78 → 86	H4	6216 30	H4	6216 30		
HORIZON	78 → 86	H4	6216 30	H4	6216 30		
EXPRESS	83 →	R2	6216 41	R2	6216 41		
MATRA RANCHO	77 → 84	H4	6216 30	H4	6216 30	H3	6216 33
SAMBA	78 → 86	H4	6216 30	H4	6216 30		
SIMCA 1100	73 → 86	H4	6216 30	H4	6216 30		
SOLARA		H4	6216 30	H4	6216 30		
TAGORA	81 → 84	H4	6216 30	H1	6216 47		
Pour TOYOTA							
CAMRY	84 →	H4	6216 30	H4	6216 30		
CAMRY	91 → 96	H1	6216 47	H1	6216 47	H1	6216 47
CAMRY	97	H4/H7	6216 30 6216 56	H4/H7	6216 30 6216 56		
CARINA	81 → 84	H4	6216 30	H4	6216 30		
CARINA II	84 →	H4	6216 30	H4	6216 30		
CARINA E	93 →	H4	6216 30	H4	6216 30	H3	6216 33
CELICA 2,0 L GT/4x4	86	H4	6216 30	H4	6216 30	H3	6216 33
COROLLA	83 → 87	H4	6216 30	H4	6216 30		
COROLLA Coupé	83 → 87	H4	6216 30	H4	6216 30		

							
Pour TOYOTA (suite)							
COROLLA	87 → 92	H4	6216 30	H4	6216 30		
COROLLA	92 → 97	H1	6216 47	H1	6216 47	H1	6216 47
COROLLA	97 →	H4	6216 30	H4	6216 30		
HI-ACE	83 → 90	R2	6216 41	R2	6216 41		
HI-ACE	90 → 96	H4	6216 30	H4	6216 30		
HI-LUX	83 → 96	R2	6216 41	R2	6216 41		
LAND CRUISER	88 → 97	H4	6216 30	H4	6216 30		
LAND CRUISER	97 →	H4	6216 30	H4	6216 30		
LAND CRUISER	90	H4	6216 30	H1	6216 47		
LEXUS		H4	6216 30	H4	6216 30	H3	6216 33
LITE ACE	83 →	H4	6216 30	H4	6216 30		
MR 2	85 → 90	H4	6216 30	H4	6216 30		
MR2	90 →	H4	6216 30	H4	6216 30	H3	6216 33
PASSEO		H4	6216 30	H4	6216 30		
PICNIC		H7	6216 56	H3	6216 33		
AVENSIS		H7	6216 56	H7	6216 56		
PREVIA		H4	6216 30	H4	6216 30	H1	6216 47
RAV 4		H7	6216 56	H7	6216 56		
SPACE CRUISER	83 → 91	H4	6216 30	H4	6216 30		
STARLET 1.0/.2/1.3	78 → 84	H4	6216 30	H4	6216 30		
STARLET	85 → 96	H4	6216 30	H4	6216 30		
STARLET	96 →	H4	6216 30	H4	6216 30		
SUPRA Turbo	86 →	H4	6216 30	H4	6216 30	H3	6216 33
TERCEL 1.3	79 → 85	H4	6216 30	H4	6216 30		
TERCEL 1.5/4x4	82 → 88	H4	6216 30	H4	6216 30		
Pour VOLKSWAGEN							
1200/1300/1303/1600	76 → 86	R2	6216 41	R2	6216 41		
BORA		H7	6216 56	H7	6216 56		
CADDY	83 →	H4	6216 30	H4	6216 30	H3	6216 33
CADDY	95 →	H4	6216 30	H4	6216 30	H3	6216 33
CORRADO	89 →	H4	6216 30	H3	6216 33		
GOLF I	74 → 80	H4	6216 30	H4	6216 30	H3	6216 33
GOLF I	81 → 83	H4	6216 30	H4	6216 30	H3	6216 33
GOLF II	84 →	H4	6216 30	H4	6216 30	H3	6216 33
GOLF III Alternativ	93 →	H1	6216 47	H1	6216 47	H1	6216 47
GOLF III GTi	93 →	H1	6216 47	H1	6216 47	H1	6216 47
GOLF III Cabrio	95 →	H4	6216 30	H4	6216 30	H3	6216 33
GOLF I Cabrio	79 → 91	H4	6216 30	H4	6216 30	H3	6216 33
GOLF II GTi	79 →	H4	6216 30	H4	6216 30	H3	6216 33
GOLF GTi/G60		H4	6216 30	H4	6216 30	H3	6216 33
GOLF IV		H7	6216 56	H1	6216 47	H3	6216 33
BEETLE		H7	6216 56	H1	6216 47		
JETTA I	79 → 83	H4	6216 30	H4	6216 30	H3	6216 33
JETTA II	84 →	H4	6216 30	H4	6216 30	H3	6216 33

DROITS DE PROPRIETE

"Les droits de propriété intellectuelle relatifs aux informations techniques contenues dans cette brochure appartiennent exclusivement au Constructeur. Toute reproduction et/ou diffusion de tout ou partie de ces informations sont interdites sans autorisation écrite préalable du Constructeur."
"Les informations techniques contenues dans la présente documentation sont destinées exclusivement aux professionnels de la réparation automobile. Dans certains cas, ces informations peuvent concerner la sécurité des véhicules.
Elles seront utilisées par les réparateurs automobiles auxquels elles sont destinées, sous leur entière responsabilité, à l'exclusion de celle du Constructeur."
"Les informations techniques figurant dans cette brochure peuvent faire l'objet de mises à jour en fonction de l'évolution des caractéristiques des modèles de chaque gamme.
Nous invitons les réparateurs automobiles à se mettre en rapport périodiquement avec le Constructeur/avec son réseau, pour se procurer les mises à jour nécessaires."

F

PROPERTY RIGHTS

"The intellectual copyrights relating to the technical information contained in this brochure are the exclusive property of the Manufacturer. Any reproduction and/or distribution of all or part of this information is forbidden without the Manufacturer's preliminary written authorisation."
"The technical information contained in this documentation is intended exclusively for automobile repair professionals. In certain cases, the information may relate to vehicle safety.
It will be used by the automobile repairers to whom it is addressed, on their full responsibility, to the exclusion of the Manufacturer's liability."
"The technical information that figures in this brochure may be updated in accordance with the changing features of models in each range.
We would request automobile repairers to get in touch with the Manufacturer/the network at regular intervals, to obtain the necessary updates."

GB

DERECHOS DE PROPIEDAD

"Los derechos de propiedad intelectual relativos a las informaciones técnicas que figuran en este folleto pertenecen exclusivamente al Constructor. Se prohíbe toda reproducción y/o difusión de la totalidad o parte de estas informaciones sin autorización previa y por escrito del Constructor."
"Las informaciones técnicas que figuran en la presente documentación están destinadas exclusivamente a los profesionales de la reparación de automóviles. En ciertos casos, pueden afectar a la seguridad de los vehículos.
Serán utilizadas por los reparadores de automóviles, a quienes están destinadas, bajo su entera responsabilidad, excluyéndose la del Constructor."
"Las informaciones técnicas que figuran en este folleto pueden ser objeto de actualizaciones en función de la evolución de las características de los modelos de cada gama.
Invitamos a los reparadores de automóviles a ponerse en contacto periódicamente con el Constructor/con su red, para conseguir las actualizaciones necesarias."

E

DIREITOS DE PROPRIEDADE

"Os direitos de propriedade intelectual relativos às informações técnicas contidas nesta brochura pertencem exclusivamente ao Construtor. Qualquer reprodução e/ou difusão da totalidade ou parte destas informações são proibidas sem a autorização prévia e escrita do Construtor."
"As informações técnicas contidas na presente documentação destinam-se exclusivamente aos profissionais da reparação automóvel. Em certos casos, estas informações podem referir-se à segurança dos veículos.
Serão utilizadas pelos reparadores automóvel a que se destinam, sob a sua total responsabilidade, excluindo a responsabilidade do Construtor."
"As informações técnicas que figuram nesta brochura podem ser objecto de actualizações consoante a evolução das características dos modelos de cada gama.
Os reparadores automóvel são convidados a entrarem periodicamente em contacto com o Construtor/com a sua rede, para obterem as actualizações necessárias."

P

EIGENTUMSRECHTE

"Die Rechte auf geistiges Eigentum in Verbindung mit den in der vorliegenden Broschüre enthaltenen technischen Informationen stehen ausschließlich dem Hersteller zu. Jede vollständige oder teilweise Reproduktion und/oder Verbreitung dieser Informationen sind ohne vorherige schriftliche Genehmigung des Herstellers verboten."
"Die in der vorliegenden Dokumentation enthaltenen technischen Informationen sind ausschließlich für Autoreparaturfachleute bestimmt. In einigen Fällen können diese Informationen die Sicherheit der Fahrzeuge betreffen.
Sie werden von den Kraftfahrzeughandwerkern, für die sie bestimmt sind, in ihrer eigenen Verantwortung benutzt, unter Ausschluß der Verantwortung des Herstellers."
"Die in dieser Broschüre enthaltenen technischen Informationen können je nach Fortentwicklung der verschiedenen Modelle in jeder Produktreihe aktualisiert werden.
Wir fordern die Kraftfahrzeughandwerker auf, sich regelmäßig an den Hersteller/an sein Vertriebsnetz zu wenden, um sich die erforderlichen Aktualisierungen zu beschaffen".

D

DIRITTI DI PROPRIETÀ

"I diritti di proprietà intellettuale riguardanti le informazioni tecniche contenute nel presente manuale appartengono esclusivamente al Costruttore. Qualsiasi riproduzione e/o diffusione di tutto o parte di queste informazioni sono vietate senza autorizzazione preventiva scritta del Costruttore."
"Le informazioni tecniche contenute nella presente documentazione sono destinate esclusivamente agli autoriparatori. In alcuni casi, queste informazioni possono riguardare la sicurezza dei veicoli.
Esse verranno utilizzate dagli autoriparatori ai quali esse sono destinate sotto la loro piena responsabilità, ad esclusione di quella del Costruttore."
"Le informazioni tecniche contenute nel presente manuale possono essere soggetto ad aggiornamenti in funzione dell'evoluzione delle caratteristiche dei modelli di ogni gamma.
Invitiamo gli autoriparatori a mettersi in contatto periodicamente con il Costruttore/la sua rete, per procurarsi gli aggiornamenti necessari."

I

EIGENDOMSRECHT

"Het individuele eigendomsrecht betreffende technische informatie die in deze brochure staat vermeld behoort exclusief aan de Fabrikant. Alle reproductie en/of verspreiding van alles of een gedeelte van deze informatie is verboden zonder voorafgaande, schriftelijke toestemming van de Fabrikant."
"De technische informatie die in deze documentatie staat vermeld is alleen bestemd voor vakmensen in de branche van de automobielreparatie. In bepaalde gevallen kan deze informatie betrekking hebben op de veiligheid van de wagens.
Deze wordt gebruikt door automobielreparateurs waarvoor zij is bestemd, onder hun volledig verantwoordelijkheid, waardoor die van de Fabrikant vervalt."
"De technische informatie die in deze brochure staat vermeld kan onderhavig zijn aan aanvullingen als gevolg van een ontwikkeling in de technische gegevens van de modellen van elke serie.
Wij vragen de automobielreparateurs zich regelmatig met de Fabrikant of zijn netwerk in verbinding te stellen, om deze noodzakelijke aanvullingen te verkrijgen."

NL