

**Cat. AUTRES MARQUES**



**AMORTISSEUR**

EDITION 09/2003 - CAT. 14 791

**CITROËN**

**F**

Nos produits recouvrent une approbation obligatoire de notre Laboratoire et de notre Service Médical sur les compositions chimiques et sur leur nature à préserver l'homme et son environnement. Toutes ces informations sont contenues dans les Fiches de Données de Sécurité. Tout utilisateur en contact avec des produits dangereux doit pouvoir en prendre connaissance.  
Vous pouvez les consulter sur INTERNET : <http://www.quickfds.com>

Pour connaître les dernières dates de mise à jour, voir DOC FLASH : DIF/DOC/MKSP

**GB**

All our products and their chemical components have been approved by our test laboratories and medical team, confirming that they do not exert a negative environmental impact. All this information is contained in related Coshh sheets. All users handling hazardous products must be able to access this information.

It can be found on the INTERNET : <http://www.quickfds.com>

To see the latest update refer to DOC FLASH : DIF/DOC/MKSP

**E**

Nuestros productos pasan por la aprobación de nuestro Laboratorio y de nuestro Servicio Médico sobre las composiciones químicas y su naturaleza, preservando al hombre y al medio ambiente. Todas estas informaciones se encuentran contenidas en las fichas de Datos de Seguridad. Todo utilizador en contacto con productos peligrosos debe tener conocimiento de ellas.  
Vds. pueden consultarlas en INTERNET : <http://www.quickfds.com>

Para conocer las últimas fechas de puesta al día, ver DOC FLASH : DIF/DOC/MKSP

**P**

Os nossos produtos estão aprovados pelo nosso Laboratório e Serviços de Saúde quanto à sua composição química, defesa do homem e do ambiente. Todas estas informações estão nas fichas de dados de segurança. Todo o utilizador destes produtos deverá ter conhecimento. Podem ser consultados na INTERNET : <http://www.quickfds.com>

Para saber as últimas datas de actualização, ver DOC FLASH : DIF/DOC/MKSP

**D**

Unsere produkte unterliegen der freigabe durch unser Labor und unseres "medizinischen service" bezüglich ihrer chemischen zusammensetzung und ihrer umweltverträglichen eigenschaften. Alle informationen sind in den sicherheitsdatenblättern enthalten. Jedem anwender dieser gefahrenstoffe müssen diese zugänglich sein.  
Abfrage im INTERNET möglich : <http://www.quickfds.com>

Die Daten der aktuellen Ausgaben finden Sie in : DOC FLASH : DIF/DOC/MKSP

**I**

I nostri prodotti ricoprono un'approvazione obbligatoria del nostro laboratorio e del nostro servizio medico sulle composizioni chimiche e sulla loro natura a preservare l'uomo e il suo ambiente naturale. Tutte queste informazioni sono presenti nelle schede di sicurezza. Tutte le persone in contatto con dei prodotti pericolosi devono poter prenderne conoscenza.  
Potete consultarli su INTERNET : <http://www.quickfds.com>

Per conoscere l'ultima data aggiornamento vedere DOC FLASH : DIF/DOC/MKSP





**NL**



De chemische samenstelling en de eventuele effecten op mens en natuur van onze producten zijn door onze laboratoria en Medische Dienst goedgekeurd. Al deze informatie staan vermeld op veiligheidskaarten. Elke gebruiker die in aanraking komt met gevaarlijke stoffen moet hiervan kennis kunnen nemen  
U kunt hiervoor INTERNET raadplegen : <http://www.quickfds.com>

Voor de laatste versiedatum, zie DOC FLASH : DIF/DOC/MKSP



**FICHE QUALITE DES EDITIONS CATALOGUE PIECES AUTO  
AMENDMENT REQUEST QUALITY FORM PARTS CATALOGUE  
FICHA CALIDAD DE LAS EDICIONES CATALOGOS PIEZAS AUTO  
FICHA QUALIDADE EDIÇÕES CATÁLOGOS PEÇAS AUTO  
QUALITÄTS-DATENBLATT KATALOGAUSGABEN KFZ-TEILE  
SCHEDA QUALITÀ DELLE EDIZIONI CATALOGHI PEZZI AUTO  
KVALITEITSFICHE ONDERDELENCATALOGUS**

EXPEDITEUR / SENDER	DESTINATAIRE / RECIPIENT
SOCIETE / COMPANYY :	CITROËN / DSPC / MKSP
NOM / NAME :	NOM / NAME : Didier PAPILLAUD
 .....	 01.58.79.73.95
 .....	 <a href="mailto:didier.papillaud@mpsa.com">didier.papillaud@mpsa.com</a>
 .....	

N° CAT 14. . . . .   . . . / 200 .

**ANOMALIE / CORRECTION / ANOMALIA / ANOMALIA / ANOMALIEN / ANOMALIA / FOUNT**



**SUGGESTION / SUGGESTION / SUGERENCIA / SUGESTÃO / VORSCHLÄGE / SUGGERIMENTO / SUGGESTIE**





**AMORTISSEUR**  
**ABSORBER - AMORTIGUADOR - AMORTECDOR**  
**STOSSDÄMPFER - AMMORTIZZATORE - SCHOKBREKER**

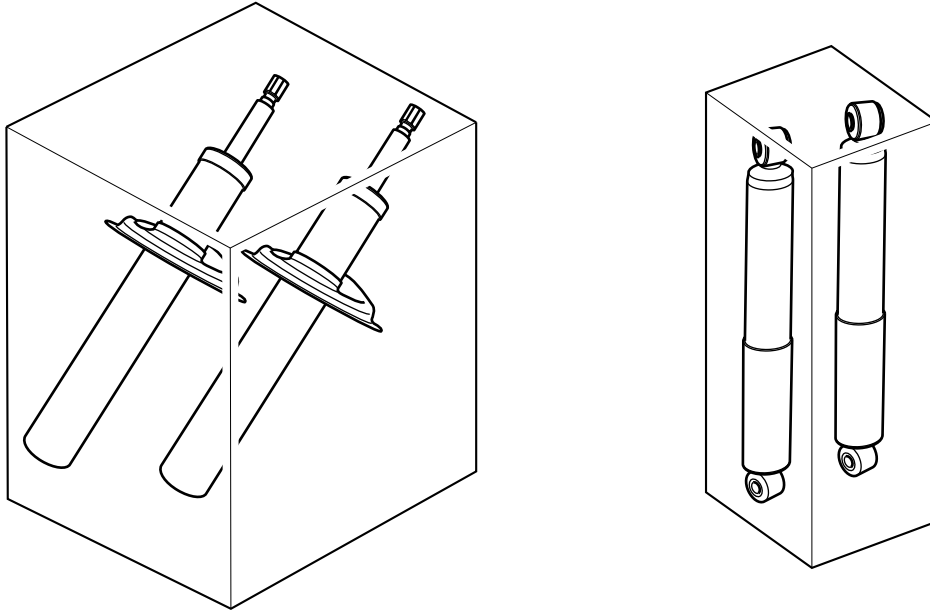

**KITS DE BUTEES DE SUSPENSION**  
**MACPHERSON SUSPENSION STRUT BEARING KIT - KIT D RODAMIENTOS**  
**DE SUSPENSION MAC PHERSON - CONJUNTO DE TROPEÇADOS DE**  
**SUSPENSÃO - REPARATURSATZ FÜR FEDERBEINLAGER FÜR**  
**MACPHERSON - KIT REGGISPINTA PAR SOSPENSIONI MAC PHERSON**  
**AXIAALLAGERS KITS VOOR DE MACPHERSON OPHANGING**

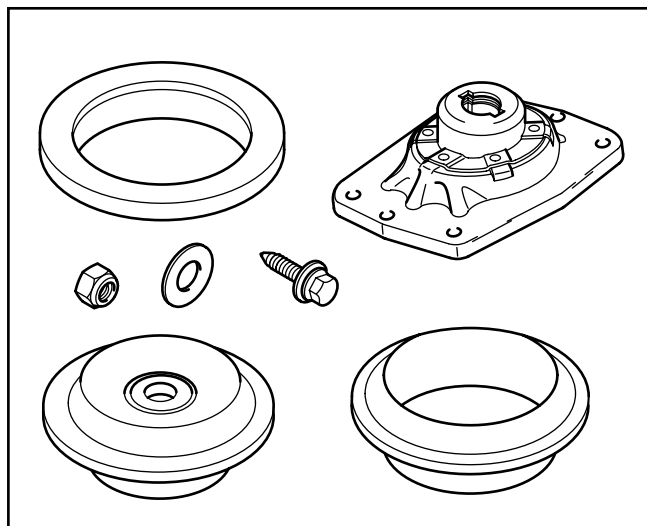

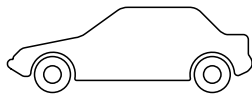

- Véhicule
- Vehicle
- Vehiculos
- Veículos
- Wagen
- Veicolo
- Automobielen



- Validité
- Validity
- Validez
- Validade
- Gültigkeit
- Validita'
- Geldgheidsduur



- Temps de remplacement (en min) d'une paire (2) d'amortisseurs. Ce temps est donné à titre indicatif.
- Replacement times in minutes for a pair (2) shock absorbers. This time is to be used as a guideline only.
- Tiempo de sustitucion (en minutos) para 1 par (2) de amortiguadores. Este tiempo, solo debe usarse a titulo de orientacion.
- Tempo de substituição (em minutos) para 1 par (2) de amortecedores. Deve ser usado apenas como orientação.
- Auswechselzeit (in minuten) für 1 Satz (2 Stück), ist als Richtlinie zu betrachten.
- Sostizione (in min) ammortizzatori (coppia). I tempi sono puramente indicativi.
- Vervangingstijd (in minuten) voor 1 paar (2) schokdempers, Deze tijd dient als richtlijn.

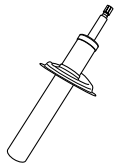

- AMORTISSEURS AVANT
- FRONT SHOCK ABSORBER
- AMORTIGUADOR DELANTERO
- AMORTECEDOR DA FRENTE
- STOSSDÄMPFER VORN
- AMMORTIZZATORE ANTERIORE
- SCHOKDEMPERS VOOR

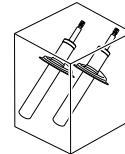

- PAIRE (2) D'AMORTISSEURS AVANT
- PAIR (2) FRONT SHOCK ABSORBER
- PAR (2) DE AMORTIGUADOR DELANTERO
- PAR (2) DE AMORTECEDOR DA FRENTE
- SATZ (2 STÜCKS) STOSSDÄMPFER VORN
- COPPIA AMMORTIZZATORE ANTERIORE
- PAAR (2) SCHOKDEMPERS VOOR

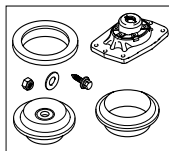

- KITS DE BUTEES DE SUSPENSION
- MACPHERSON SUSPENSION STRUT BEARING KIT
- KIT D RODAMIENTOS DE SUSPENSION MAC PHERSON
- CONJUNTO DE TROPEÇADOS DE SUSPENSÃO
- REPARATURSATZ FÜR FEDERBEINLAGER FÜR MACPHERSON
- KIT REGGISPINTA PAR SOSPENSIONI MAC PHERSON
- AXIAALLAGERS KITS VOOR DE MACPHERSON OPHANGING



- AMORTISSEURS ARRIERE
- REAR SHOCK ABSORBER
- AMORTIGUADOR TRASERO
- AMORTECEDOR ATRAS
- STOSSDÄMPFER HINTEN
- AMMORTIZZATORE POSTERIORE
- SCHOKDEMPERS ACHTER

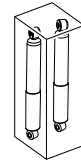

- PAIRE (2) D'AMORTISSEURS ARRIERE
- PAIR (2) REAR SHOCK ABSORBER
- PAR (2) DE AMORTIGUADOR TRASERO
- PAR (2) DE AMORTECEDOR ATRAS
- SATZ (2 STÜCKS) STOSSDÄMPFER HINTEN
- COPPIA AMMORTIZZATORE POSTERIORE
- PAAR (2) SCHOKDEMPERS ACHTER

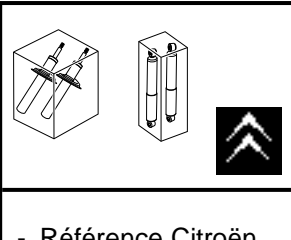

- Référence Citroën
- Citroën part number
- Referencia Citroën
- Referencia Citroën
- Referenz Citroën
- Riferimento Citroën
- Citroën referentie

- **Les références en caractère gras** = pièces "autre marque"
- **Part number in bold** = other makes
- **Las referencias en negrita** = piezas "otras marcas"
- **As referências em caractere bold** = peças "outras marcas"
- **Fett gedruckte teilenummern** = teile "andere mersteller"
- **I riferimenti in grassetto** = pezzi altre marche
- **Onderdeelnummers vet gedrukt** = onderdelen "andere merken"
  
- **Les références en caractère normal** = pièces Citroën polyvalentes
- **Part numbers in standard font** = Citroën and other makes
- **Las referencias en carácter normal** = piezas Citroën polivalantes
- **As referências em caractere normal** = peças Citroën polivalantes
- **Nicht hervor gehobene teilenummern** = Citroën-teil mehrfacher anwendungsbereich
- **I riferimenti non in grassetto** = pezzi Citroën polivalenti
- **Onderdeelnummers niet vet gedrukt** = onderdelen Citroën (neerdere toepassingen)







- --> **1990 : jusqu'à 1990** - TO - HASTA EL - ATE - BIS - FINO A - TOT
- **1990 -> : à partir de 1990** - FROM - A PARTIR DEL - A PARTIR DE - AB - A PARTIR DA - VANAF
- **AIRBAG CONDUCTEUR** - DRIVER AIRBAG - AIRBAG CONDUCTOR - AIRBAG CONDUTOR - AIRBAG LEITEND - AIRBAG CONDUTTORE - AIRBAG LEIDEND
- **AMBULANCE** - Ambulance - Ambulancia - Ambulância - Krankenwagen - Ambulanza - Ziekenwagen
- **AR : ARRIERE** - REAR - DETRAS - TRASEIRA - ACHTER - POSTERIORE - ACHTER
- **AV : AVANT** - FRONT- DELANTE - FRENTE - VORNE - ANTERIORE - VOOR
- **BARRE DE TORSION** - TORSION BARS - BARRA DE TORSIÓN - BARRA DE TORÇÃO - TORSIONSSTÄBE - SBARRA DI TORSIONE - TORSIESTANGEN
- **BERL : BERLINE** - SALOON - BERLINA - BERLINA - LIMOUSINE - BERLINA - SEDAN
- **BREAK** - ESTATE - BREAK - BREAK - KOMBI - BREAK - STATIONWAGEN
- **BVA : BOITE DE VITESSE AUTOMATIQUE** - AUTOMATIC GEARBOX - CAJA DE CAMBIOS AUTOMATICA - CAIXA DE VELOCIDADES AUTOMATICA - AUTOMATIK-GETRIEBE - SCATOLA CAMBIO VELICITA - AUTOMATICA - AUTOMATISCHE VERSNELLINSBAK
- **BVM : BOITE DE VITESSE MANUELLE** - MANUAL GEARBOX - CAJA DE CAMBIOS MANUAL - CAIXA DE VELOCIDADES MANUAL - MANUELLES GETRIEBE - SCATOLA CAMBIO VELICITA MANUELE - HANDGE SCHADELDE VERSNELLINSBAK
- **CABRIOLET** - CONVERTIBLE - CABRIOLET - CABRIOLET - CABRIO - CABRIOLET - CABRIOLET
- **CARBU : CARBURATION** - CARBURATION - CARBURACION - CARBURAÇÃO - VERGASUNG - CARBURAZIONE - CARBURATIE
- **CARTER CYLINDRE ALU** - CASING ALUMINIUM - CARTER ALUMINIO - CARTER ALUMINIO - GEHAUSE ALUMINIUM - CARTER ALUMINIUM - CARTER ALUMINIUM
- **CARTOUCHE MAC PHERSON** - MAC PHERSON INSERT - CARTUCHO MACPHERSON - CARTUCHO MACPHERSON - MAC PHERSON FEDERBEINEINSATZ - CARTUCCIA MACPHERSON - MACPHERSON VERVAN GINGSPATROON
- **CH : CHASSIS** - CHASSIS - CHASSIS - CHASSIS - CHASSIS - TELAIO - CHASSIS
- **COUPE** - COUPE- COUPE - COUPE- COUPE- COUPE- COUPE
- **CU+ : CHARGE UTILE AUGMENTEE** - Increased payload - Carga util incrementada - Sobrecarga- Erhöhter nutzlast - Sospensioni rinforzate - Verzwaaarde belading
- **DA : DIR ASSIST : DIRECTION ASSISTEE** - POWER STEERING - DIRECCION ASITIDA - DIRECÇÃO ASSIS TIDA - SERVOLENKUNG - DIREZIONE ASSISTITA - STUURBEK-RACHTIGING
- **DIESEL** - DIESEL - DIESEL - DIESEL - DIESEL - DIESEL - DIESEL
- **DIRECTION MANUELLE** - MANUAL STEERING - DIRECCION NON ASITIDA - DIRECÇÃO NAO ASSISTIDA OHNE SERVOLENKUNG - DIREZIONE NON ASSISTITA - HANDDIRECTIE
- **ENT : ENTREPRISE** - COMPANY - EMPRESA - EMPRESA - ENTREPRISE - SOCIETA - BEDRIJK
- **ESS SANS PB : ESSENCE SANS PLOMB** - LEADFREE PETROL - GAZOLINA SIN PLOMO - GAZOLINA SEM CHUMBO - BLEIFREIES BENZIN - BENZINA SENZA PIOMBO - LOODVRIJE
- **ESSENCE** - PETROL - GASOLINA - GASOLINA - BENZIN - BENZINA SENZA PIOMBO - BENZINE
- **FOURGON COURT** - SHORT VAN - FURGON CORTO - FURGÃO CURTO - KURZLIEFERWAGEN - FURGO NE CORTO - BESTELWAGEN KORT
- **FOURGONNETTE FAMILIALE** - ESTATE VAN - FURGONETA FAMILIAR - FURGONETA FAMILIAR - LIEFER WAGEN FAMILIALE - FURGONCINO FAMILIARE - BESTELWAGEN FAMILIALE
- **GPL : GAZ DE PETROLE LIQUEFIE** - LPG - GPL - GPL - LPG - GPL - LPG
- **INJECTION** - INJECTION - INYECCION - INJECÇÃO - EINSPRITZUNG - INIEZIONE - INJECTIE
- **JAMBE DE FORCE MAC PHERSON** - COMPLETE MACPHERSON STRUT - PIERNA DE FUERZA MAC PHERSON - PERNA DE FORÇA MACPHERSON - KOMPLETTES MACPHERSON FEDERBEIN - GAMBA DI FORZA MACPHERSON - KOMPLETE MACPHERSON VERPOOT

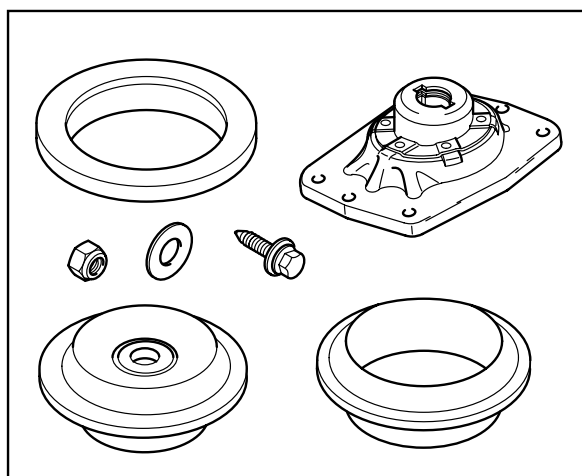
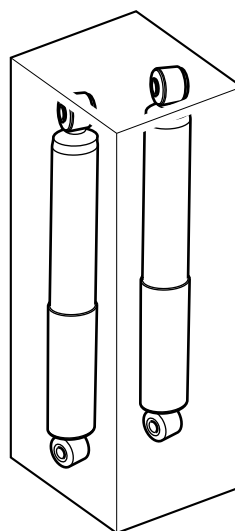
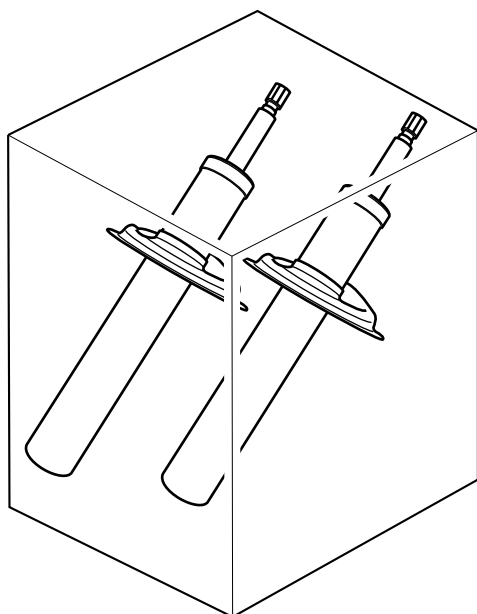

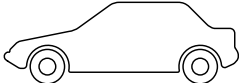

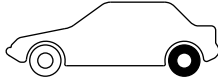

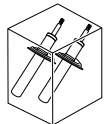
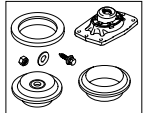
- **MOTEUR ELECTRIQUE** - ELECTRIC ENGINE - MOTOR ELECTRICO - MOTOR ELECTRICO - ELEKTRO FAHRZEUG - MOTORE ELETTRICO - ELEKTRISCHE MOTOR
- **NIVEAU** - LEVEL - NIVEL - NIVEL - FÜLLSTAND - LIVELLO - PEIL
- **P : PTES : PORTES** - DOOR            PUERTA - PORTA - TÜR - PORTIERA - DEUR
- **PAVILLON MULTIFONCTION** - MULTIFUNCTION ROOF - TECHO MULTIFUNCION - TEJADILHO MULTIFUNÇÃO - MULTIFUNKTIONSDACH - TETTO MULTIFUNZIONZ - MODUTOP
- **PNEU** - TYRE - NEUMATICO - PNEU - REIFEN - PNEUMATICO - BAND
- **POUR** - FOR - PARA - PARA - FÜR - PER - VOOR
- **PROTECTION SOUS CAISSE** - ENGINE PROTECTION - PROTECCION MOTOR - PROTECÇÃO MOTOR - MOTORSCHUTZ - PROTEZIONE MOTORE - MOTORBESCHERMING
- **ROUTES INEGALES** - BAD ROAD - MALA CARRETERA - ESTRADA MA - SCHLECHTE STRASSE - STRADA IN CATTIVE CONDIZIONI - SLECHTE WEG
- **S : N° SERIE** - SERIAL N° - N° SERIE - N° SERIE - SERIENNR - N° DI SERIE - SERIENUMMER
- **SANS** - WITHOUT - SIN - SEM - OHNE - SENZA - ZONDER
- **SAUF** - EXCEPT - SALVO - SALVO - AUSSER - TRANNE - BEHALVE
- **SN : SUSPENSION NORMALE** - NORMAL SUSPENSION - SUSPENCION NORMAL - SUSPENSÃO NORMAL NORMALE AUFHÄNGUNG - SOSPENSIONE NORMALE - NORMALE VERING
- **SUSPENSION PILOTEE** - CONTROLLED SUSPENSION - SUSPENSÓN CONTROLADA - SUSPENSÃO PILOTADA GESTEUERTE SUSPENSION - SOSPENSIONE CONTROLLATA - GEREDEN OPSCHORTING
- **SUSPENSION PNEUMATIQUE** - AIR SUSPENSION - SUSPENSÓN NEUMÁTICA - SUSPENSÃO PNEUMÁTICA - LUFTFEDERUNG - SOSPENSIONE PNEUMATICA - LUCHTVERING
- **SUSPENSION REHAUSSEE** - RAISED SUSPENSION - SUSPENSION REALZADA - SUSPENSÃO SOBRELEVADA - ERHÖHTE FEDERUNG - SOSPENSIONE RIALZATA - VERHOOGDE VERING
- **SUSPENSION RENFORCE** - REINFORCED SUSPENSION - SUSPENCION REFORZADA - SUSPENSÃO REFORCADA - VERSTAKTE AUFHÄNGUNG - SOSPENSIONE RAFFORZATA - VERSTERKTE OPHANGI
- **SUSPENSION SURBAISSEE** - FLATTENED SUSPENSION - SUSPENSÓN APLANADA - SUSPENSÃO REBAIXADA - GEDRÜCKTE SUSPENSION - SOSPENSIONE APPIATTITA - VERLAAGDE OPSCHORTING
- **TIGE EMBOUT CONIQUE** - CONICAL STEM END - TRONCO CONTERA CÓNICA - CAULE TÉRMINO CÓNICO - STAMM KONISCHES ENDE - GAMBO FINE CONICA - HOOFDLIJN NIET SCHROEVEN KEGEL VORMIG
- **TIGE EMBOUT DROIT** - STEM RIGHT END - TRONCO CONTERA DERECHA - CAULE TÉRMINO DIREITO STAMM GERADES ENDE - GAMBO FINE DIRITTA - HOOFDLIJN NIET SCHROEVEN RECHT
- **TOUS MODELES** - ALL MODELS - TODOS LOS MODELOS - TODOS OS MODELOS - ALLE MODELLE TUTTI I MODELLI - ALLE MODELLEN
- **UTILITAIRE** - UTILITY VEHICLE - CAMIONETA - CAMIONETA - KLEINLASWAGEN - CAMIONCINO LICHTEVRACTHWAGEN

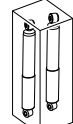

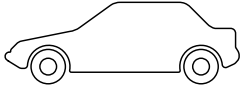

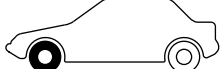
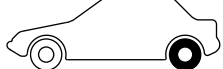

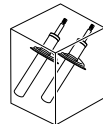
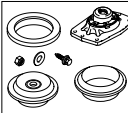

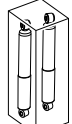



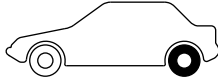

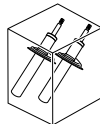
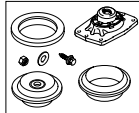
- 1**
- TRI PAR MARQUES
  - LISTED BY MANUFACTURER
  - CLASIFICADO POR MARCAS
  - TRI POR MARCAS
  - GEORDNET NACH MARKEN
  - ORDINE ALFABETICO PER MARCHE
  - OP MERK VOLGORDE

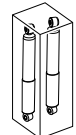

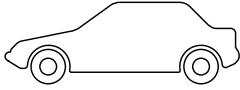

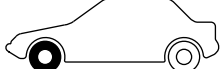
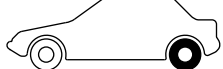

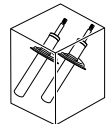
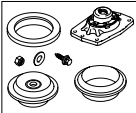

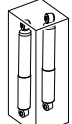



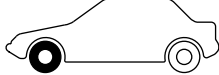
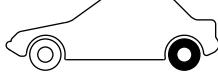

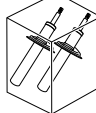
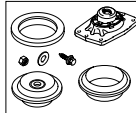
								
								
<b>POUR ALFA ROMEO</b>								
<b>145 / 146</b>								
1.3 (Boxer)	03.95 -> 1997					55		5204 66
1.6 (Boxer)	03.95 -> 1997					55		5204 66
1.7ie 16V (Boxer)	03.95 -> 1997					55		5204 66
2.0TS (Boxer)	03.95 -> 1997					55		5204 66
1.4, 1.6, 1.8, 2.0 (L4)	11.96 ->					55		5204 66
1.9 TDS	07.94 ->					55		5204 66
1.9 JTD	1999 ->					55		5204 66
<b>POUR AUDI</b>								
<b>Audi 80</b>								
berline , break sauf Quattro	09.78 ->1986	195		5204 04	5030 40	85		5204 63
tous modèles sauf Quattro, suspension surbaissée	1986 -> 07.91	220		5204 04	5030 40	85		5204 63
berline sauf Quattro, V6, S2, sport susp.	08.91 -> 09.94	220		5204 04	5030 40			
break sauf V6, Quattro, Sport Susp.	08.91 -> 09.95	220		5204 04	5030 40			
<b>Audi 90</b>								
tous modèles sauf Quattro	1984 -> 1986	195		5204 04	5030 40	85		5204 63
tous modèles sauf 2.3L, Quattro, suspension surbaissée	1987 -> 07.91	220		5204 04	5030 40	85		5204 63
<b>A3</b>								
tous modèles sauf Quattro, Sport Susp.	1996 -> 06.99				5030 42	40		5204 62
tous modèles sauf Quattro, Sport Susp.	06.99 ->				5030 42	40		5204 62
<b>CABRIOLET</b>								
	05.91 ->				5030 40			
<b>COUPE</b>								
tous modèles sauf Quattro	1980 -> 1989	195		5204 04	5030 40	85		5204 63
<b>TT</b>								
1.8 20V / 1.8 20V Turbo	10.98 ->				5030 42			
<b>POUR AUTOBIANCHI</b>								
<b>Y10</b>								
tous modèles (4x2)	03.85 -> 1992					40		5204 77
<b>POUR BEDFORD</b>								
<b>ASTRA</b>								
Astra utilitaire	1982 -> 1984	145		5204 05				
Astra utilitaire	1984 -> 07.91	145		5204 05				
Astra Max	1985 -> 07.91	145		5204 05				
<b>POUR DAEWOO</b>								
<b>ESPERO</b>								
tous modèles	01.95 ->			5204 05				5204 72
<b>LANOS</b>								
tous modèles	1997 ->			5204 05				5204 72
<b>NEXIA / CIELO</b>								
tous modèles	01.95 ->			5204 05				5204 72
<b>POUR FIAT</b>								
<b>BRAVA</b>								
1.4, 1.6 (->Ch. 4085697)	1995 -> 1996	40		5204 53	5030 03	45		5204 74
1.4 (Ch. 4085697->) direction assistée, 1.9D	1996 ->	40		5204 59	5030 03	45		5204 74
1.6	1995 ->	40		5204 59	5030 04 + 5030 05	45		5204 74

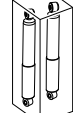

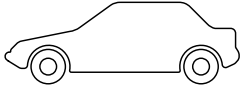

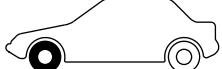
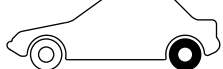

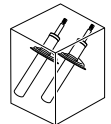
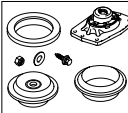
										
										
<b>POUR FIAT</b>										
<b>BRAVA</b>										
1.8, 1.9TD (75 & 100/105)	1995 ->				5030 03	45			5204 74	
<b>BRAVA / BRAVO</b>										
1.4, 1.6 (->Ch. 4085697)	1995 -> 1996	40		5204 53	5030 03	45			5204 74	
1.4 (Ch. 4085697->) direction assistée, 1.9D	1996 ->	40		5204 59	5030 03	45			5204 74	
1.6	1995 ->	40		5204 59	5030 03	45			5204 74	
1.8, 1.9TD (75 & 100/105)	1995 ->				5030 03	45			5204 74	
2.0 Sport	10.95 ->				5030 04 + 5030 05					
<b>MAREA</b>										
berline, break 1.4, 1.6, 1.8	1996 ->				5030 03				5204 74	
berline, break 1.9TD-75, 1.9TD-100	1996 ->				5030 03				5204 74	
<b>PALIO / SIENA</b>										
break	1998 ->					25			5204 74	
<b>PANDA</b>										
tous modèles sauf 4x4	1980 -> 1986	70		5204 18	5030 06					
tous modèles sauf 4x4	1986 ->	70		5204 18	5030 06	30			5204 77	
<b>PUNTO</b>										
1.1, 1.2, 1.6, 1.7D	11.93 -> 1999	85		5204 55	5030 01	50			5204 71	
1.4 Turbo G.T.	11.93 -> 1999					50			5204 71	
1.7 Turbo Diesel	11.93 -> 1999	85		5204 56	5030 01	50			5204 71	
<b>SCUDO</b>										
	06.95 -> 09.97		5202 K8		5031 66 + 5031 67		5206 E4			
	09.97 -> 09.00				5031 66 + 5031 67					
	09.00 ->				5031 68 + 5031 69					
<b>TEMPRA</b>										
berline 1.4, 1.6, 1.9D	1990 ->	70		5204 53	5030 04 + 5030 05	45			5204 06	
berline 1.8, 2.0, 1.9TD	1990 ->				5030 04 + 5030 05	45			5204 66	
break 1.4, 1.6, 1.9D (4x2)	1990 ->	70		5204 53	5030 04 + 5030 05					
<b>TIPO</b>										
1.1, 1.4, 1.6, 1.7 D, 1.9 D	1988 ->	70		5204 53	5030 04 + 5030 05				5204 66	
1.8i, 1.8i-16V, 1.9TD, 2.0i	1988 ->				5030 04 + 5030 05	45			5204 74	
2.0ie-16V	1991 ->				5030 04 + 5030 05	45			5204 74	
<b>ULYSSE</b>										
sauf XU7JP	06.94 -> 09.97		5202 H1		5031 66 + 5031 67		5206 E8			
sauf XU7JP	01.98 -> 09.00		5202 H1		5031 66 + 5031 67		5206 R4			
sauf XU7JP	09.00 -> 03.02		5202 H1		5031 68 + 5031 69		5206 R4			
XU7JP	09.96 -> 09.97		5202 K8		5031 66 + 5031 67		5206 E8			
XU7JP	01.98 -> 09.00		5202 K8		5031 66 + 5031 67		5206 R4			
XU7JP	09.00 -> 03.02		5202 K8		5031 68 + 5031 69		5206 R4			

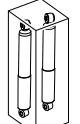
								
								
<b>POUR FIAT</b>								
<b>ULYSSE R</b>								
	03.02 ->		5202 FY + 5202 FZ		5031 68 + 5031 69			
<b>UNO</b>								
tous modèles sauf Turbo	1983 -> 1995	80		5204 11	5030 02	50		5204 82
<b>POUR FORD</b>								
<b>COURRIER</b>								
utilitaire sauf Diesel	1991 -> 12.93	120		5204 24	5030 09			
utilitaire Diesel	1991 -> 12.93	120		5204 24	5030 07			
utilitaire sauf Diesel	01.94 -> 1995	120		5204 32	5030 09			
utilitaire Diesel	01.94 -> 1995	120		5204 32	5030 07			
utilitaire sauf Diesel	11.95 ->	120		5204 42	5030 10			
utilitaire Diesel	11.95 ->	120		5204 43	5030 10			
<b>ESCORT III / IV</b>								
berline, break sauf XR3	1980 -> 05.83					55		5204 06
berline, break sauf Diesel, XR3	06.83 -> 11.84	60		5204 16		55		5204 06
berline, break sauf Diesel, XR3	12.84 -> 01.86	60		5204 16	5030 09	55		5204 06
berline, break Diesel	06.83 -> 11.84	60		5204 20	5030 07	55		5204 06
berline, break Diesel	12.84 -> 01.86	60		5204 20	5030 07	55		5204 06
berline, break sauf Diesel, XR3, RS	01.86 -> 07.90	60		5204 16	5030 09	55		5204 06
berline, break Diesel	01.86 -> 07.90	60		5204 20	5030 07	55		5204 06
cabriolet sauf XR 3i	06.83 -> 11.84			5204 16	5030 09			5204 06
cabriolet sauf XR 3i	12.84 -> 07.90			5204 16	5030 09			5204 06
<b>ESCORT V</b>								
berline 1.1, 1.3	08.90 -> 1995	90		5204 27	5030 08	45		5204 99
break 1.3	08.90 -> 08.95	90		5204 27	5030 08			
break 1.3i	08.95 -> 1999	90		5204 27	5030 08			
berline 1.4	08.90 -> 10.90	90		5204 27	5030 08	45		5204 99
break 1.4	08.90 -> 10.90	90		5204 27	5030 08			
berline 1.4	10.90 -> 1995	90		5204 21	5030 08	45		5204 99
berline 1.4i	08.90 -> 1995	90		5204 21	5030 08			
break 1.4, 1.4i	08.90 -> 1995	90		5204 21	5030 08			
berline 1.6	08.90 -> 1995	90		5204 21	5030 08	45		5204 99
berline 1.6i	08.90 -> 1995	90		5204 21	5030 08			
break 1.6, 1.6i, 1.6i 16V	08.90 -> 1995	90		5204 21	5030 08			
berline 1.6i 16V (4x2)	01.95 -> 1999			5204 58	5030 11	45		5204 A4
break 1.6i 16V	01.95 -> 08.95			5204 58	5030 11			
break 1.6i 16V	08.95 -> 1999			5204 58	5030 11			
berline 1.8i sauf Sport	01.92 -> 1995	90		5204 21	5030 08	45		5204 99
berline 1.8i Sport	01.92 -> 1995	90		5204 21	5030 08			
break 1.8i	01.92 -> 1995	90		5204 21	5030 08			
berline 1.8i, i-16V	01.95 -> 1999			5204 58	5030 11	45		5204 A4
break 1.8i, i-16V	01.95 -> 08.95			5204 58	5030 11			
break 1.8i, i-16V	08.95 -> 1999			5204 58	5030 11			
berline 1.8D	08.90 -> 10.90	90		5204 27	5030 08	45		5204 99
break 1.8D	08.90 -> 10.90	90		5204 27	5030 08			
berline 1.8D/TD	10.90 -> 1995	90		5204 21	5030 08	45		5204 99
break 1.8D/TD	10.90 -> 1995	90		5204 21	5030 08			
berline 1.8D/TD	01.95 -> 1999			5204 58	5030 11	45		5204 A4
break 1.8D/TD	01.95 -> 08.95			5204 58	5030 11			
break 1.8D/TD	08.95 -> 1999			5204 58	5030 11			

										
										
<b>POUR FORD</b>										
<b>ESCORT V</b>										
cabriolet	01.95 -> 1999			<b>5204 58</b>	<b>5030 11</b>	45				<b>5204 A4</b>
utilitaire 500 kg	1991 -> 1995	90		<b>5204 27</b>	<b>5030 08</b>					
utilitaire 500 kg	01.95 -> 1999			<b>5204 58</b>	<b>5030 11</b>					
utilitaire 700 kg	1991 -> 1995	90		<b>5204 21</b>	<b>5030 08</b>					
utilitaire 700 kg	01.95 -> 1999			<b>5204 58</b>	<b>5030 11</b>					
<b>FIESTA I</b>										
tous modèles sauf XR2	1976 -> 08.83					50				<b>5204 92</b>
<b>FIESTA II</b>										
tous modèles sauf XR2	09.83 -> 11.84	120		<b>5204 15</b>	<b>5030 09</b>	50				<b>5204 92</b>
tous modèles Essence sauf XR2	12.84 -> 12.88	120		<b>5204 15</b>	<b>5030 09</b>	50				<b>5204 92</b>
Diesel	12.84 -> 12.88	120		<b>5204 15</b>	<b>5030 07</b>	50				<b>5204 92</b>
<b>FIESTA III</b>										
1.0, 1.1, 1.3, 1.4, 1.6	01.89 -> 12.93	120		<b>5204 19</b>	<b>5030 09</b>	50				<b>5204 98</b>
1.4S, 1.6S, 1.8Si	01.89 -> 12.93	120		<b>5204 24</b>	<b>5030 09</b>	50				<b>5204 98</b>
1.8D, 1.8TD	01.89 -> 12.93	120		<b>5204 24</b>	<b>5030 07</b>	50				<b>5204 98</b>
XR 2i, RS 1800	01.89 -> 12.93					50				<b>5204 98</b>
utilitaire essence (sauf Courier)	01.89 -> 12.93	120		<b>5204 19</b>	<b>5030 09</b>	50				<b>5204 98</b>
utilitaire Diesel (sauf Courier)	01.89 -> 12.93	120		<b>5204 19</b>	<b>5030 07</b>	50				<b>5204 98</b>
1.1, 1.3, 1.4 C/CLX/Ghia/Youth/ Classic (direction manuelle)	01.94 -> 08.95	120		<b>5204 31</b>	<b>5030 09</b>	50				<b>5204 A1</b>
1.1, 1.3, 1.4 C/CLX/Ghia/Youth/ Classic (direction manuelle)	01.94 -> 08.95	120		<b>5204 32</b>	<b>5030 09</b>	50				<b>5204 A1</b>
1.1 SX/Classic	01.94 -> 08.95	120		<b>5204 32</b>	<b>5030 09</b>	50				<b>5204 A1</b>
1.3 SX/Classic	01.94 -> 08.95	120		<b>5204 32</b>	<b>5030 09</b>	50				<b>5204 A1</b>
1.4 SI/SX/Futura/Classic	01.94 -> 08.95	120		<b>5204 32</b>	<b>5030 09</b>	50				<b>5204 A1</b>
1.6 / 1.6 Classic	01.94 -> 08.95	120		<b>5204 32</b>	<b>5030 09</b>	50				<b>5204 A1</b>
1.8 D / TD Classic	01.94 -> 08.95	120		<b>5204 31</b>	<b>5030 07</b>	50				<b>5204 A1</b>
XR2i, RS 1800	01.94 -> 08.95			<b>5204 32</b>	<b>5030 09</b>					<b>5204 A1</b>
utilitaire essence (sauf Courier)	01.94 -> 08.95			<b>5204 32</b>	<b>5030 09</b>					<b>5204 A1</b>
utilitaire Diesel (sauf Courier)	01.94 -> 08.95			<b>5204 32</b>	<b>5030 07</b>					<b>5204 A1</b>
<b>FIESTA IV</b>										
1.0, 1.25, 1.3 16V, 1.4 16V sauf Classic	08.95 -> 10.98			<b>5204 42</b>	<b>5030 10</b>					<b>5204 A2</b>
1.0, 1.25, 1.3 16V	10.98 -> 2001			<b>5204 42</b>	<b>5030 10</b>					
1.4 16V, 1.6	10.98 -> 2001			<b>5204 42</b>	<b>5030 10</b>					<b>5204 A2</b>
Diesel sauf Classic	08.95 -> 10.98			<b>5204 43</b>	<b>5030 10</b>					<b>5204 A2</b>
Diesel	10.98 -> 2001			<b>5204 43</b>	<b>5030 10</b>					
<b>GALAXY</b>										
Tous modèles	02.95 ->				<b>5030 39</b>					
<b>KA</b>										
Tous modèles	09.96 ->				<b>5030 10</b>					
<b>MONDEO</b>										
berline (4x2) sauf suspension pilotée	03.93 -> 05.93					120				<b>5204 94</b>
berline (4x2) sauf suspension pilotée	06.93 -> 1996	90		<b>5204 57</b>	<b>5030 12</b>	120				<b>5204 94</b>
break CLIPPER (4x2) sauf suspension pilotée	06.93 -> 1996	90		<b>5204 57</b>	<b>5030 12</b>					
berline 1.6, 1.8, 1.8D sauf suspension pilotée	09.96 -> 10.00				<b>5030 12</b>	120				<b>5204 94</b>
berline 2.0, 2.5-V6 sauf suspension pilotée	09.96 -> 10.00					120				<b>5204 94</b>

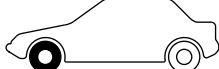
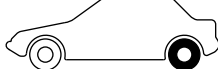
										
										
<b>POUR FORD</b>										
<b>ORION</b>										
berline sauf Diesel, 1.6i	1983 -> 11.84	90			<b>5204 16</b>		55			<b>5204 06</b>
berline sauf Diesel, 1.6i	12.84 -> 07.90	90			<b>5204 16</b>	<b>5030 09</b>	55			<b>5204 06</b>
berline Diesel	1983 -> 11.84	90			<b>5204 20</b>	<b>5030 07</b>	55			<b>5204 06</b>
berline Diesel	12.84 -> 07.90	90			<b>5204 20</b>	<b>5030 07</b>	55			<b>5204 06</b>
1.3	08.90 -> 1995	90			<b>5204 27</b>	<b>5030 08</b>	45			<b>5204 99</b>
1.4	08.90 -> 10.90				<b>5204 27</b>	<b>5030 08</b>	45			<b>5204 99</b>
1.4	10.90 -> 1995	90			<b>5204 21</b>	<b>5030 08</b>	45			<b>5204 99</b>
1.4i, 1.6, 1.6i, 1.8i saufGhia	08.90 -> 1995	90			<b>5204 21</b>	<b>5030 08</b>	45			<b>5204 99</b>
1.4i, 1.6i, 1.8i Ghia	08.90 -> 1995	90			<b>5204 21</b>	<b>5030 08</b>				
1.8D	08.90 -> 10.90	90			<b>5204 27</b>	<b>5030 08</b>	45			<b>5204 99</b>
1.8D, 1.8TD	11.90 -> 1995	90			<b>5204 21</b>	<b>5030 08</b>	45			<b>5204 99</b>
<b>P100</b>										
Tous modèles	1988 ->					<b>5030 07</b>				
<b>PUMA</b>										
tous modèles	1997 -> 10.98									<b>5204 A2</b>
<b>SIERRA</b>										
berline sauf XR4i	1982 -> 04.84						50			<b>5204 75</b>
berline Essence sauf 4x4, V6, XR4, RS Cosworth	05.84 -> 1993	60			<b>5204 23</b>	<b>5030 09</b>	50			<b>5204 75</b>
berline Diesel sauf 4x4	05.84 -> 1993	60			<b>5204 23</b>	<b>5030 07</b>	50			<b>5204 75</b>
break Essence sauf 4x4	05.84 -> 1993	60			<b>5204 23</b>	<b>5030 09</b>				
break Diesel sauf 4x4	05.84 -> 1993	60			<b>5204 23</b>	<b>5030 07</b>				
<b>POUR LANCIA</b>										
<b>DEDRA</b>										
berline, break 1.6, 1.8, 1.9TD, 2.0 (4x2)	1989 -> 12.97					<b>5030 04 + 5030 05</b>	50			<b>5204 74</b>
berline, break 2.0 16V (4x2)	09.94 -> 12.97					<b>5030 04 + 5030 05</b>	50			<b>5204 74</b>
berline, break 1.6, 1.8, 1.9TD, 2.0 (4x2)	01.98 ->					<b>5030 04 + 5030 05</b>	50			<b>5204 74</b>
berline, break 2.0 16V (4x2)	01.98 ->					<b>5030 04 + 5030 05</b>	50			<b>5204 74</b>
<b>DELTA</b>										
1400, 1600	1993 ->					<b>5030 04 + 5030 05</b>	50			<b>5204 66</b>
1800, 2000 16V	1993 ->					<b>5030 04 + 5030 05</b>	50			<b>5204 74</b>
1900 Turbo Diesel	1994 ->					<b>5030 04 + 5030 05</b>	50			<b>5204 74</b>
<b>PHEDRA</b>										
	03.02 ->			5202 FY + 5202 FZ		5031 68 + 5031 69				
<b>Y10</b>										
tous modèles (4x2)	1985 -> 1992						30			<b>5204 77</b>
<b>ZETA</b>										
sauf XU7JP	06.94 -> 09.97			5202 H1		5031 66 + 5031 67			5206 E8	
sauf XU7JP	01.98 -> 09.00			5202 H1		5031 66 + 5031 67			5206 R4	
sauf XU7JP	09.00 -> 03.02			5202 H1		5031 68 + 5031 69			5206 R4	
XU7JP	09.96 -> 09.97			5202 K8		5031 66 + 5031 67			5206 E8	

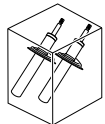
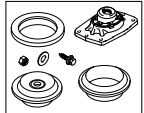
								
								
<b>POUR LANCIA</b>								
<b>ZETA</b>								
XU7JP	01.98 -> 09.00		5202 K8		5031 66 + 5031 67		5206 R4	
XU7JP	09.00 -> 03.02		5202 K8		5031 68 + 5031 69		5206 R4	
<b>POUR MAZDA</b>								
<b>121 / REVUE</b>								
1250, 1.3 16V, 1.4 16V	08.95 -> 09.98			5204 42	5030 10			5204 A2
1250, 1.3 16V	10.98 ->			5204 42	5030 10			
1.4 16V	10.98 ->			5204 42	5030 10			5204 A2
1800D	08.95 -> 09.98			5204 43	5030 10			5204 A2
1800D	10.98 ->			5204 43	5030 10			
<b>POUR OPEL</b>								
<b>ASTRA</b>								
berline, 5P sauf GT, GSi	09.91 -> 1998	150		5204 02	5030 15	40		5204 72
break Caravan	09.91 -> 1998	150		5204 02	5030 15			
<b>CALIBRA</b>								
2.0i, 2.0i-16V, 2.5 V6 sauf Turbo, suspension pilotée	1990 ->	145		5204 03	5030 16			
<b>COMBO</b>								
utilitaire	1985 -> 1993	140		5204 05	5030 14			
<b>CORSA A</b>								
Tous modèles sauf GSi	09.82 -> 1993	150		5204 12	5030 13	50		5204 80
<b>CORSA B</b>								
Tous modèles sauf GSi	01.93 -> 11.00			5204 30	5030 13	50		5204 87
<b>KADETT D</b>								
berline sauf GTE	1979 -> 08.84	140		5204 05				
break	1979 -> 08.84	140		5204 05				
<b>KADETT E</b>								
berline 1.2, 1.3, 1.4, 1.6 (->Ch.J 2791967) (->Ch.J 5273427)	08.84 -> 07.88	140		5204 05	5030 14			
berline 1.2, 1.3, 1.4, 1.6 (Ch.J 2791968->) (Ch.J 5273428->)	08.88 -> 07.91	140		5204 05	5030 14	25		5204 72
break Caravan	08.84 -> 07.91	140		5204 05	5030 14			
utilitaire COMBO	1985 -> 1993	140		5204 05	5030 14			
<b>TIGRA</b>								
tous modèles	1994 ->				5030 13			
<b>VECTRA A</b>								
tous modèles sauf 4x4, 16V, V6, GT	09.88 -> 1995	145		5204 03	5030 16	40		5204 72
1.8 4x4, 2.0i 4x4 sauf GT	09.88 -> 1995	145		5204 03	5030 16			
2.0i-16V sauf 4x4, GT (->Ch.NV199999) (->Ch.N1999999) (->Ch.N5999999)	09.88 -> 1992	145		5204 03	5030 16			
2.0i-16V sauf 4x4, GT (Ch.NV199999->) (Ch.N1999999->) (Ch.N5999999->)	09.88 -> 1992	145		5204 03	5030 16	40		5204 72

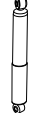
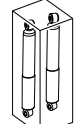
								
								
<b>POUR PEUGEOT</b>								
<b>106 (-&gt; 96)</b>								
Berline entreprise 3 portes SN sauf TUD5 (Tige embout droit) (-> S 50265608)	10.92 ->		5202 FH		5031 54			
Berline entreprise 3 portes SN sauf TUD5 (Tige embout droit) (S 50265609 ->)	10.92 ->		5202 FH		5031 53			
Carbu TU1 Niveau 3 SN (-> S 50265608)	09.91 ->		5202 FH		5031 54			
Carbu TU1 Niveau 3 SN (S 50265609 ->)	09.91 ->		5202 FH		5031 53			
Carbu TU1 SN sauf Niveau 3 (-> S 50265608)	09.91 ->		5202 FN		5031 54		5206 G3	
Carbu TU1 SN sauf Niveau 3 (S 50265609 ->)	09.91 ->		5202 FN		5031 53		5206 G3	
Carbu TU3 (-> S 50265608)	09.91 ->		5202 FH		5031 54			
Carbu TU3 (S 50265609 ->)	09.91 ->		5202 FH		5031 53			
Carbu TU3-2 SN (-> S 50265608)	09.91 ->		5202 FH		5031 54			
Carbu TU3-2 SN (-> S 50265608)	03.94 ->		5202 FN		5031 54			
Carbu TU3-2 SN (S 50265609 ->)	09.91 ->		5202 FH		5031 53			
Carbu TU3-2 SN (S 50265609 ->)	03.94 ->		5202 FN		5031 53			
Carbu TU9 SN (-> S 50265608)	09.91 ->		5202 FN		5031 54		5206 G3	
Carbu TU9 SN (S 50265609 ->)	09.91 ->		5202 FN		5031 53		5206 G3	
Diesel TUD3 SN (-> S 50265608)	10.92 ->		5202 FN		5031 54		5206 G3	
Diesel TUD3 SN (S 50265609 ->)	10.92 ->		5202 FN		5031 53		5206 G3	
Diesel TUD5 Berl Ent 3ptes SN (-> S 50265608)	07.94 ->				5031 54		5206 Q2	
Diesel TUD5 Berl Ent 3ptes SN (S 50265609 ->)	07.94 ->				5031 53		5206 Q2	
Diesel TUD5 SN (-> S 50265608)	07.94 ->		5202 FN		5031 54			
Diesel TUD5 SN (S 50265609 ->)	07.94 ->		5202 FN		5031 53			
Diesel TUD5 SN sauf Berl Ent 3ptes (-> S 50265608)	07.94 ->				5031 54		5206 F8	
Diesel TUD5 SN sauf Berl Ent 3ptes (S 50265609 ->)	07.94 ->				5031 53		5206 F8	
Injection TU1M Niveau 1 sans ABR (-> S 50265608)	09.91 ->		5202 FN		5031 54		5206 G3	
Injection TU1M Niveau 1 sans ABR (S 50265609 ->)	09.91 ->		5202 FN		5031 53		5206 G3	
Injection TU1M Niveau 1 SN avec ABR (-> S 50265608)	02.93 ->		5202 FH		5031 54			
Injection TU1M Niveau 1 SN avec ABR (S 50265609 ->)	02.93 ->		5202 FH		5031 53			
Injection TU1M Niveau 2 sans ABR (tige embout conique) (-> S 50265608)	09.91 ->		5202 FN		5031 54			



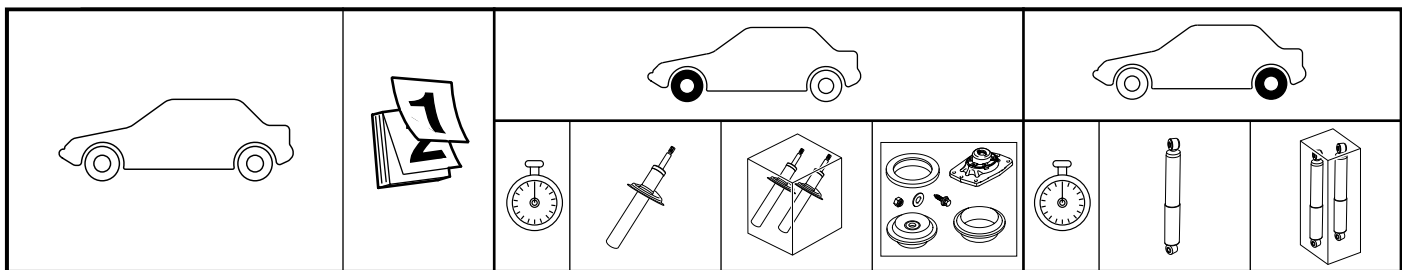

### POUR PEUGEOT

#### 106 (-> 96 )

Injection TU1M Niveau 2 sans ABR (tige embout conique) (S 50265609 ->)	09.91 ->		5202 FN		5031 53			
Injection TU1M Niveau 2 SN avec ABR (-> S 50265608)	02.93 ->		5202 FH		5031 54			
Injection TU1M Niveau 2 SN avec ABR (S 50265609 ->)	02.93 ->		5202 FH		5031 53			
Injection TU1M Niveau 3 SN (-> S 50265608)	09.91 ->		5202 FH		5031 54			
Injection TU1M Niveau 3 SN (S 50265609 ->)	09.91 ->		5202 FH		5031 53			
Injection TU2J2 Rallye SN (-> S 50265608)	10.93 ->		5202 FH		5031 54		5206 S0	
Injection TU2J2 Rallye SN (S 50265609 ->)	10.93 ->		5202 FH		5031 53		5206 S0	
Injection TU3J SN (-> S 50265608)	09.91 ->		5202 FH		5031 54		5206 S0	
Injection TU3J SN (S 50265609 ->)	09.91 ->		5202 FH		5031 53		5206 S0	
Injection TU3M SN (-> S 50265608)	09.91 ->		5202 FH		5031 54			
Injection TU3M SN (-> S 50265608)	03.94 ->		5202 FN		5031 54			
Injection TU3M SN (S 50265609 ->)	09.91 ->		5202 FH		5031 53			
Injection TU3M SN (S 50265609 ->)	03.94 -		5202 FN		5031 53			
Injection TU3MC (carter cylindre Alu) SN (-> S 50265608)	09.91 ->				5031 54		5206 Q2	
Injection TU3MC (carter cylindre Alu) SN (S 50265609 ->)	09.91 ->				5031 53		5206 Q2	
Injection TU3MC SN (-> S 50265608)	09.91 ->		5202 FH		5031 54			
Injection TU3MC SN (-> S 50265608)	03.94 ->		5202 FN		5031 54			
Injection TU3MC SN (S 50265609 ->)	09.91 ->		5202 FH		5031 53			
Injection TU3MC SN (S 50265609 ->)	03.94 ->		5202 FN		5031 53			
Injection TU5J2 SN (-> S 50265608)	03.94 ->		5202 FH		5031 54		5206 S0	
Injection TU5J2 SN (S 50265609 ->)	03.94 ->		5202 FH		5031 53		5206 S0	
Injection TU5JP 90CV BVA SN (-> S 50265608)	06.95 ->		5202 FC		5031 54			
Injection TU5JP 90CV BVA SN (S 50265609 ->)	06.95 ->		5202 FC		5031 53			
Injection TU5JP 90CV Niveau 5 SN (-> S 50265608)	07.94 ->		5202 FC		5031 54			
Injection TU5JP 90CV Niveau 5 SN (S 50265609 ->)	07.94 ->		5202 FC		5031 53			

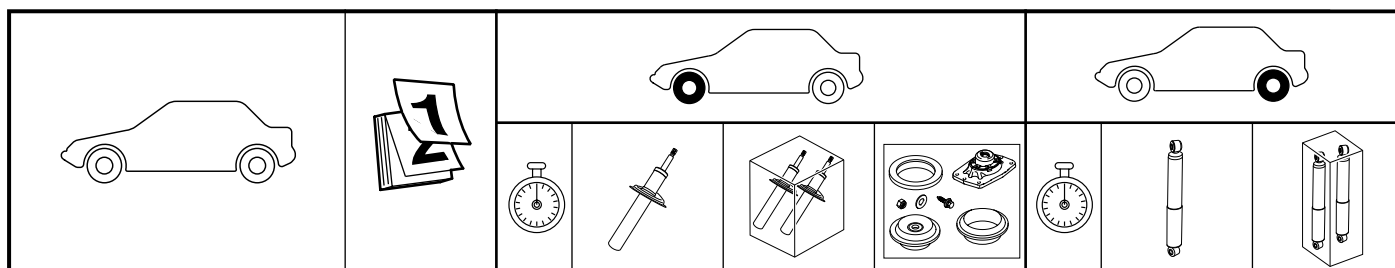

**POUR PEUGEOT**

**106 ( -> 96 )**

Injection TU5JP 90CV sauf Niveau 5 (-> S 50265608)	07.94 ->		5202 FN		5031 54		5206 Q2	
Injection TU5JP 90CV sauf Niveau 5 (S 50265609 ->)	07.94 ->		5202 FN		5031 53		5206 Q2	
Injection TU9M Niveau 1 sans ABR (-> S 50265608)	09.91 ->		5202 FN		5031 54		5206 G3	
Injection TU9M Niveau 1 sans ABR (S 50265609 ->)	09.91 ->		5202 FN		5031 53		5206 G3	
Injection TU9M Niveau 2 sans ABR (-> S 50265608)	09.91 ->		5202 FN		5031 54			
Injection TU9M Niveau 2 sans ABR (S 50265609 ->)	09.91 ->		5202 FN		5031 53			
Injection TU9M Niveau 2 SN avec ABR (-> S 50265608)	02.93 ->		5202 FH		5031 54			
Injection TU9M Niveau 2 SN avec ABR (S 50265609 ->)	02.93 ->		5202 FH		5031 53			
Moteur électrique SA13 (-> S 50265608)	02.93 ->		5202 FH		5031 54			
Moteur électrique SA13 (-> S 50265608)	07.95 ->		5202 FN		5031 54		5206 F5	
Moteur électrique SA13 (S 50265609 ->)	02.93 ->		5202 FH		5031 53			
Moteur électrique SA13 (S 50265609 ->)	07.95 ->		5202 FN		5031 53		5206 F5	
Suspension renforcée AV/AR (-> S 50265608)	07.92 ->		5202 FF		5031 54		5206 H8	
Suspension renforcée AV/AR (S 50265609 ->)	07.92 ->		5202 FF		5031 53		5206 H8	





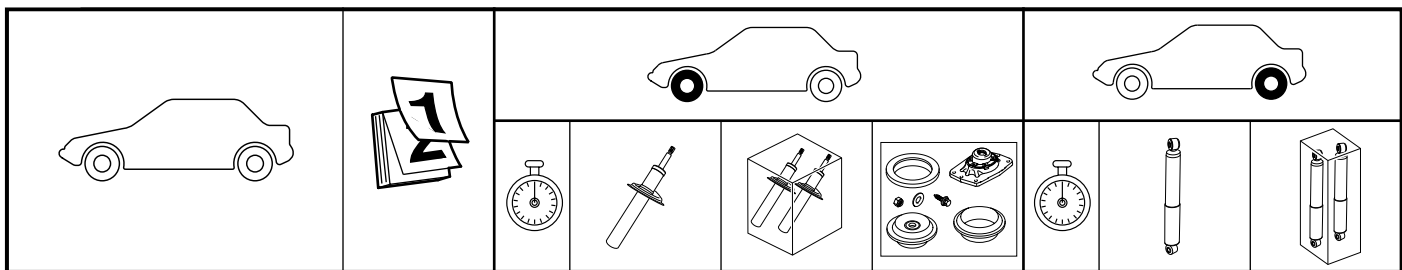

**106 ( 96 -> )**

Carbu TU1 direction non assistée	04.96 -> 03.03		5202 FN		5031 53		5206 G3	
Carbu TU3-2 SN	03.96 -> 07.03		5202 FH		5031 53		5206 H0	
Diesel TUD5 berl Entr SN	03.96 -> 07.03		5202 FN		5031 53		5206 Q2	
Diesel TUD5 berl VP SN	03.96 -> 07.03		5202 FN		5031 53			
Diesel TUD5B berl Ent 3ptes SN	09.01 -> 07.03		5202 FN		5031 53		5206 Q2	
Diesel TUD5B Berl VP SN	09.01 -> 07.03		5202 FN		5031 53			
Injection TU1JP SN	05.00 -> 07.03		5202 FN		5031 53			
Injection TU1JP SN Berl Ent 3ptes	05.00 -> 07.03				5031 53		5206 Q2	
Injection TU1JP SN Berl VP Sport, Quicksilver	05.00 -> 07.03				5031 53		5206 H0	
Injection TU1M+ Berl Ent 3ptes SN	03.96 -> 07.03				5031 53		5206 Q2	
Injection TU1M+ Berl Ent 3ptes SN GPL+Ess ss Pb	09.98 -> 07.03				5031 53		5206 Q2	
Injection TU1M+ berl VP sauf Sport	03.96 -> 07.03		5202 FN		5031 53			
Injection TU1M+ berl VP Sport	03.96 -> 07.03		5202 FH		5031 53		5206 H0	
Injection TU1M+ berl VP sans dir assist sans airbag conducteur SN	03.96 -> 07.03				5031 53		5206 G3	
Injection TU1M+ berl VP sans dir assist niveau 1+2 SN	03.96 -> 03.98				5031 53		5206 G3	

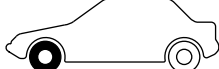
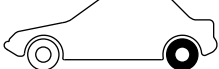

### POUR PEUGEOT

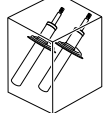
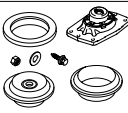

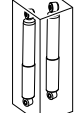

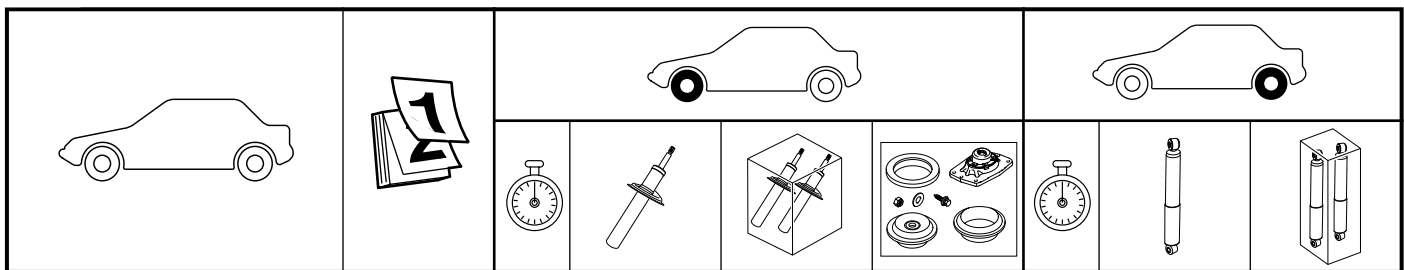

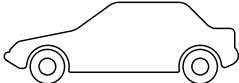

<b>106 ( 96 -&gt; )</b>							
Injection TU1M+ berl VP sans dir assist, Active SN	03.98 -> 07.03				5031 53		5206 G3
Injection TU3JP BVA SN	06.97 -> 07.03		5202 FN		5031 53		
Injection TU3JP BVM active SN	03.98 -> 07.03		5202 FN		5031 53		
Injection TU3JP BVM classic SN	03.98 -> 07.03		5202 FN		5031 53		
Injection TU3JP BVM niveau 2 SN	03.96 -> 03.98		5202 FN		5031 53		
Injection TU3JP BVM niveau 2S SN	03.96 -> 03.98		5202 FH		5031 53		5206 H0
Injection TU3JP BVM niveau 3 SN	03.96 -> 03.98		5202 FN		5031 53		
Injection TU3JP BVM niveau 5 SN	03.96 -> 03.98		5202 FN		5031 53		
Injection TU3JP BVM sport SN	03.98 -> 07.03		5202 FH		5031 53		5206 H0
Injection TU3JP pneu 165x65x14H	02.97 -> 07.03		5202 FH		5031 53		5206 H0
Injection TU5J2 SN	04.96 -> 03.03		5202 Q9		5031 53		
Injection TU5J4 SN	06.96 -> 07.03		5202 Q9		5031 53		
Injection TU5JP BVA SN	06.96 -> 04.98		5202 FN		5031 53		
Injection TU5JP BVM Niveau 2S SN	03.96 -> 03.98		5202 FH		5031 53		5206 H0
Injection TU5JP BVM sauf niveau 2S SN	03.96 -> 03.98		5202 FN		5031 53		
Injection TU9M berl Entr 3P SN	03.96 -> 07.98		5202 FN		5031 53		5206 Q2
Injection TU9M berl VP airbag conducteur SN	03.96 -> 07.03		5202 FN		5031 53		
Injection TU9M berl VP sans airbag conducteur SN	03.96 -> 07.03				5031 53		5206 G3
Moteur électrique SA13	05.96 -> 07.03		5202 FN		5031 53		5206 F5
Suspension renforcée AV/AR	03.96 -> 07.03		5202 FF		5031 53		5206 H8
<b>205</b>							
tous modèles SN sauf GTi, CTi, Rallye, Turbo D, F	1983 ->		96085227		<b>5030 22</b>	50	<b>5204 A5</b>
CTi	1985 ->	180		<b>5204 44</b>	<b>5030 22</b>	50	<b>5204 A5</b>
Turbo Diesel	1990 ->				<b>5030 22</b>	50	<b>5204 A5</b>
Gentry	1991 ->				<b>5030 22</b>	50	<b>5204 A5</b>
utilitaire F	1994 ->			<b>5204 44</b>	<b>5030 22</b>		
<b>306 ( -&gt;97 )</b>							
Berline 4 portes SN	09.94 -> 04.97		5202 P9 + 5202 Q3		<b>(+DA) 5030 18 / (-DA) 5030 17</b>		<b>5204 A5</b>
Berline Entreprise 3 ptes SN	03.94 -> 04.97		5202 P9 + 5202 Q3		<b>(+DA) 5030 18 / (-DA) 5030 17</b>		<b>5204 A5</b>
Carbu TU3-2 berl 3/5 ptes SN pneu 175x65x14	02.93 -> 04.97		5202 P9 + 5202 Q3		<b>(+DA) 5030 18 / (-DA) 5030 17</b>		<b>5204 A5</b>
Carbu TU3-2 Berl 3/5 ptes SN pneu 175x70x13	02.93 -> 04.97		5202 P9 + 5202 Q3		<b>(+DA) 5030 18 / (-DA) 5030 17</b>		<b>5204 A5</b>
Diesel XUD7 berl 3/5 ptes SN	02.93 -> 04.97		5202 P9 + 5202 Q3		<b>(+DA) 5030 18 / (-DA) 5030 17</b>		<b>5204 A5</b>
Diesel XUD9 Berl 3/5 ptes SN	07.93 -> 04.97		5202 P9 + 5202 Q3		<b>(+DA) 5030 18 / (-DA) 5030 17</b>		<b>5204 A5</b>

								
								
<b>POUR PEUGEOT</b>								
<b>306 ( -&gt;97 )</b>								
Diesel Turbo XUD9TE berl 3/5 ptes SN	07.93 -> 04.97		5202 P9 + 5202 Q3		(+DA) 5030 18 / (-DA) 5030 17			5204 A5
Inj TU3JP berl 3/5 ptes SN pneu 175x70x13	06.96 -> 04.97		5202 P9 + 5202 Q3		(+DA) 5030 18 / (-DA) 5030 17			5204 A5
Inj TU3MC Berl 3/5 ptes SN pneu 175x65x14	02.93 -> 04.97		5202 P9 + 5202 Q3		(+DA) 5030 18 / (-DA) 5030 17			5204 A5
Inj TU3MC Berl 3/5 ptes SN pneu 175x70x13	02.93 -> 04.97		5202 P9 + 5202 Q3		(+DA) 5030 18 / (-DA) 5030 17			5204 A5
Inj TU5JP 90CV Berl 3/5 ptes SN	02.93 -> 04.97		5202 P9 + 5202 Q3		(+DA) 5030 18 / (-DA) 5030 17			5204 A5
Inj XU7JP Berl 3/5 ptes SN	02.93 -> 04.97		5202 P9 + 5202 Q3		(+DA) 5030 18 / (-DA) 5030 17			5204 A5
Inj XU10J2 BVA berl 3/5 ptes ISRAEL	11.93 -> 04.97		5202 P9 + 5202 Q3		(+DA) 5030 18 / (-DA) 5030 17			5204 A5
<b>306 ( 97-&gt; )</b>								
Carbu TU suspension renforcée AV/AR	06.97 ->		5202 AV + 5202 AW		(+DA) 5030 18 (-DA) 5030 17			
Diesel DW suspension renforcée AV/AR	11.98 ->		5202 AV + 5202 AW		(+DA) 5030 18 (-DA) 5030 17			
Diesel DW8	11.98 ->		5202 P9 + 5202 Q3		(+DA) 5030 18 / (-DA) 5030 17			5204 A5
Diesel DW8B	11.99 ->		5202 P9 + 5202 Q3		(+DA) 5030 18 / (-DA) 5030 17			5204 A5
Diesel Turbo DW10TD SN	03.99 ->		5202 P9 + 5202 Q3		(+DA) 5030 18 / (-DA) 5030 17			5204 A5
Diesel Turbo XUD9TE	04.97 ->		5202 P9 + 5202 Q3		(+DA) 5030 18 / (-DA) 5030 17			5204 A5
Diesel XUD7	04.97 ->		5202 P9 + 5202 Q3		(+DA) 5030 18 / (-DA) 5030 17			5204 A5
Diesel XUD9	04.97 ->		5202 P9 + 5202 Q3		(+DA) 5030 18 / (-DA) 5030 17			5204 A5
Ess TU berl 4 ptes SN sauf GPL+Ess ss Plomb	04.97 ->		5202 P9 + 5202 Q3		(+DA) 5030 18 / (-DA) 5030 17			5204 A5
Essence TU suspension renforcée AV/AR	06.97 ->		5202 AV + 5202 AW		(+DA) 5030 18 / (-DA) 5030 17			
Inj TU3JP Berline entreprise 3 ptes	04.97 ->		5202 P9 + 5202 Q3		(+DA) 5030 18 / (-DA) 5030 17			5204 A5
Inj TU3JP SN GPL+Ess sans Plomb	10.99 ->		5202 P9 + 5202 Q3		(+DA) 5030 18 / (-DA) 5030 17			5204 A5
Inj TU5JP 100CV SN	09.00 ->		5202 P9 + 5202 Q3		(+DA) 5030 18 / (-DA) 5030 17			5204 A5
Inj TU5JP 90CV SN	04.97 ->		5202 P9 + 5202 Q3		(+DA) 5030 18 / (-DA) 5030 17			5204 A5
Inj XU10J4R SN	04.97 ->		5202 P9 + 5202 Q3		(+DA) 5030 18 / (-DA) 5030 17			
Inj XU7JP	04.97 ->		5202 P9 + 5202 Q3		(+DA) 5030 18 / (-DA) 5030 17			5204 A5
Inj XU7JP Berl 4 ptes SN	04.97 ->		5202 P9 + 5202 Q3		(+DA) 5030 18 / (-DA) 5030 17			5204 A5
Inj XU7JP4 SN	04.97 ->		5202 P9 + 5202 Q3		(+DA) 5030 18 / (-DA) 5030 17			5204 A5
Inj XU7JP4 SN sauf GPL+Ess sans Plomb	04.97 ->		5202 P9 + 5202 Q3		(+DA) 5030 18 / (-DA) 5030 17			5204 A5

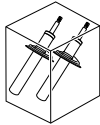
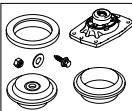

## POUR PEUGEOT

<b>306 ( 97 -&gt; )</b>								
TU5JP 100CV berline 4 portes suspension normale BVA AL4	09.00 ->		5202 AV + 5202 AW		(+DA) 5030 18 / (-DA) 5030 17			
TU5JP 90CV BVA berline 4 portes suspension normale	04.97 ->		5202 AV + 5202 AW		(+DA) 5030 18 / (-DA) 5030 17			5204 A5
Berline 4 portes suspension renforcée AV/AR	06.97 ->		5202 AV + 5202 AW		(+DA) 5030 18 / (-DA) 5030 17			
Diesel XU/XUD suspension renforcée AV/AR	06.97 ->		5202 AV + 5202 AW		(+DA) 5030 18 / (-DA) 5030 17			
Break suspension réhaussée	06.97 -		5202 AV + 5202 AW		(+DA) 5030 18 / (-DA) 5030 17			
Break suspension renforcée AV/AR	06.97 ->		5202 AV + 5202 AW		(+DA) 5030 18 / (-DA) 5030 17			
<b>309</b>								
1.1, 1.3, 1.4 (TU) SN	1985 ->	135		5204 44	5030 22	40		5204 A5
1.6 (XU5) SN sauf Gti	1985 -> 10.89			5204 44	5030 22	40		5204 A5
1.9 (XU9) SN sauf GTI, GTI-16V	1985 -> 07.88			5204 44	5030 22	40		5204 A5
1.8D, 1.9D SN	1985 ->			5204 44	5030 22	40		5204 A5
1.6 (XU5) SN sauf GTI	10.89 ->				5030 22	40		5204 A5
1.8TD (XUD7T) SN	1989 ->				5030 22	40		5204 A5
1.9 (XU9) SN sauf GTI, GTI 16V	07.88 ->				5030 22	40		5204 A5
<b>405 ( -&gt;92 )</b>								
berline 1.4/1.6/1.8 (GL/GR/SR) (-> Ch S8026754)	1987 -> 02.92	180		5204 46	5030 21			
berline 1.4/1.6/1.8 (GL/GR/SR) (Ch S8026755 ->)	02.92 -> 12.92	180		5204 46	5030 19			
berline Diesel sauf Turbo (-> Ch S8026754)	1988 -> 02.92			5204 46	5030 21			
berline Diesel sauf Turbo (Ch S8026755 ->)	02.92 -> 12.92			5204 46	5030 19			
berline Turbo Diesel (-> Ch S8026754)	1987 -> 02.92	180		5204 49	5030 21			
berline Turbo Diesel (Ch S8026755 ->)	02.92 -> 12.92	180		5204 49	5030 19			
berline GRX4, SRX4 (-> Ch S8026754)	1989 -> 02.92	180		5204 46	5030 21			
berline GRX4, SRX4 (Ch S8026755 ->)	02.92 -> 12.92	180		5204 46	5030 19			
break 1.4/1.6/1.8 (4x2) (-> Ch S8026754)	1987 -> 02.92	180		5204 46	5030 21			
break 1.4/1.6/1.8 (4x2) (Ch S8026755 ->)	02.92 -> 12.92	180		5204 46	5030 19			
break Diesel sauf Turbo (4x2) (-> Ch S8026754)	1987 -> 02.92			5204 46				
break Diesel sauf Turbo (4x2) (Ch S8026755 ->)	02.92 -> 12.92			5204 46				
break GRi, SRi, STi (4x2) (-> Ch S8026754)	1987 -> 12.92	180		5204 49	5030 21			
break GRi, SRi, STi (4x2) (Ch S8026755 ->)	1987 -> 12.92	180		5204 49	5030 21			
break Turbo Diesel (4x2) (-> Ch S8026754)	1987 -> 12.92			5204 49	5030 21			

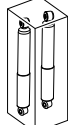
								
								
<b>POUR PEUGEOT</b>								
<b>405 ( -&gt;92 )</b>								
break Turbo Diesel (4x2) (Ch S8026755 ->)	1987 -> 12.92				<b>5204 49</b>	<b>5030 21</b>		
break (4x4) (-> Ch S8026754)	1988 -> 12.92	180			<b>5204 49</b>			
break (4x4) (Ch S8026755 ->)	1988 -> 12.92	180			<b>5204 49</b>			
<b>405 ( 92 -&gt; )</b>								
berline 1.4/1.6/1.8 (GL/GR/SR) (Ch. 70613612 ->)	1993 -> 1995	180			<b>5204 46</b>	<b>5030 20</b>		
berline Diesel sauf Turbo (Ch. 70613612 ->)	1993 -> 1995				<b>5204 46</b>	<b>5030 20</b>		
berline Turbo Diesel (Ch. 70613612 ->)	1993 -> 1995	180			<b>5204 49</b>	<b>5030 20</b>		
berline GRX4, SRX4 (Ch. 70613612 ->)	1993 -> 1995	180			<b>5204 46</b>	<b>5030 20</b>		
break 1.4/1.6/1.8 (4x2) (Ch. 70613612 ->)	1993 ->	180			<b>5204 46</b>	<b>5030 20</b>		
break Diesel sauf Turbo (4x2) (Ch. 70613612 ->)	1993 ->				<b>5204 46</b>	<b>5030 20</b>		
break GRi, SRi, STi (4x2) (Ch. 70613612 ->)	1993 ->	180			<b>5204 49</b>	<b>5030 20</b>		
break Turbo Diesel (4x2) (Ch. 70613612 ->)	1993 ->				<b>5204 49</b>	<b>5030 20</b>		
break (4x4) (Ch. 70613612 ->)	1993 ->	180			<b>5204 49</b>	<b>5030 20</b>		
<b>406</b>								
berline 1.6i, 1.8, 2.0i	1996 ->	100			<b>5204 36</b>	<b>5030 23</b>	60	<b>5204 86</b>
berline 1.9D/TD, 2.0HDi	1996 ->				<b>5204 36</b>	<b>5030 23</b>	60	<b>5204 86</b>
break 1.6i, 1.8, 2.0i	1996 ->	100			<b>5204 36</b>	<b>5030 23</b>		
break 1.9D/TD, 2.0HDi	1996 ->				<b>5204 36</b>	<b>5030 23</b>		
<b>605</b>								
tous modèles sauf suspension pilotée	10.89 ->	200			<b>5204 39</b>	<b>5030 24*</b>	80	<b>5204 70</b>
<b>806</b>								
Injection XU7JP sans protection sous caisse	09.96 -> 09.97		5202 K8			5031 66 + 5031 67		5206 E8
Injection XU7JP sans protection sous caisse	09.97 -> 05.00		5202 K8			5031 66 + 5031 67		5206 R4
sans protection sous caisse sauf XU7JP	06.94 -> 09.97		5202 H1			5031 66 + 5031 67		5206 E8
sans protection sous caisse sauf XU7JP	09.97 -> 05.00		5202 H1			5031 66 + 5031 67		5206 R4
sans protection sous caisse sauf XU7JP	05.00 -> 12.01		5202 H1			5031 68 + 5031 69		5206 R4
<b>807</b>								
tous modèles sauf moteurs ES	03.02 ->		5202 FY + 5202 FZ			5031 68 + 5031 69		5206 AR
<b>BOXER ( -&gt;01 )</b>								
1000 Kg	02.94 -> 09.01		5202 J3			5031 70 + 5031 71		5206 Q1
1400 Kg	02.94 -> 09.01		5202 J3			5031 70 + 5031 71		5206 Q0
1800 Kg	02.94 -> 09.01		5202 J5			5031 70 + 5031 71		5206 J2
Combi Luxe	02.94 -> 09.01					5031 70 + 5031 71		5206 P9
<b>* Roulement seul - Bearing alone - Solo rodamiento - Rolamento único - Nur rollen - Rotolamento solo - Enige circulatie</b>								

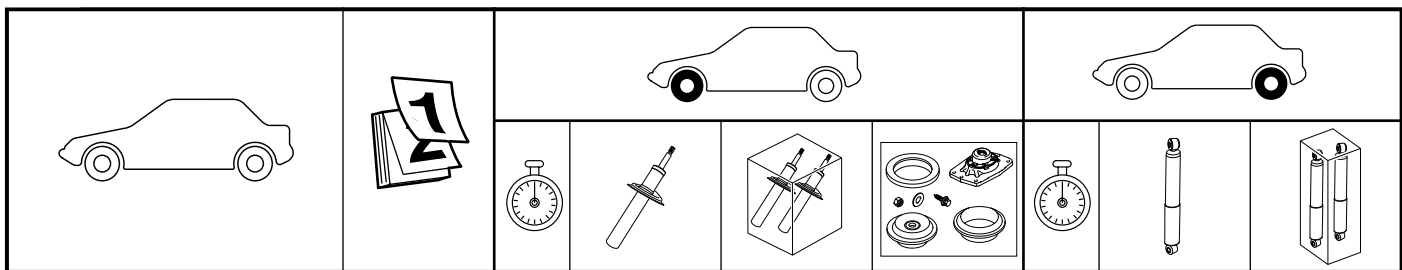

### POUR PEUGEOT

#### BOXER ( 01-> )

1000 Kg Ambulance Ent SN	09.01 ->		5202 J3		5031 78 + 5031 79		5206 Y9	
1000 Kg Combi Luxe SN	09.01 ->		5202 J3		5031 78 + 5031 79		5206 Y9	
1000 Kg Combi SN	09.01 ->		5202 J3		5031 78 + 5031 79		5206 Q1	
1000 Kg SN	09.01 ->		5202 J3		5031 78 + 5031 79		5206 Q1	
1400 Kg Ambulance Ent SN	09.01 ->		5202 J3		5031 78 + 5031 79		5206 Y9	
1400 Kg Combi Luxe SN	09.01 ->		5202 J3		5031 78 + 5031 79		5206 Y9	
1400 Kg Combi SN	09.01 ->		5202 J3		5031 78 + 5031 79		5206 Q1	
1400 Kg SN	09.01 ->		5202 J3		5031 78 + 5031 79		5206 Q1	
1800 Kg Combi SN	09.01 ->		5202 JA		5031 78 + 5031 79		5206 Y7	
1800 Kg SN	09.01 ->		5202 JA		5031 78 + 5031 79		5206 Y7	

#### EXPERT

Sauf routes inégales	06.95 -> 09.97		5202 K8		5031 66 + 5031 67		5206 E4	
Sauf routes inégales	09.97 -> 08.00		5202 K8		5031 66 + 5031 67		5206 R2	
Sauf routes inégales	09.00 ->		5202 K8		5031 68 + 5031 69		5206 R2	

#### PARTNER ( ->02 )

Fourgon court 475 kg SN	07.96 -> 09.02		5202 P9 + 5202 Q3		(+DA) 5031 73 /(-DA) 5031 72		5206 H1	
Fourgon court 600 kg SN	07.96 -> 09.02		5202 P9 + 5202 Q3		(+DA) 5031 73 /(-DA) 5031 72		5206 H1	
Fourgon court 765-800 kg SN	07.96 -> 09.02		5202 Q1 + 5202 Q5		(+DA) 5031 73 /(-DA) 5031 72		5206 H2	
Fourgon court Susp renforcée AV/AR	11.96 -> 09.02		5202 AA + 5202 AC		(+DA) 5031 73 /(-DA) 5031 72		5206 H1	
Fourgonnette familiale SN avec pavillon multifonction sauf TU3JP	11.00 -> 09.02		5202 GQ + 5202 GP		(+DA) 5031 73 /(-DA) 5031 72		5206 V1	
Fourgonnette familiale SN sans pavillon Multifonction sauf TU5JP4	11.00 -> 09.02		5202 P9 + 5202 Q3		(+DA) 5031 73 /(-DA) 5031 72		5206 H2	
Fourgonnette familiale SN sans pavillon multifonction TU5JP4	11.00 -> 09.02		5202 GT + 5202 GV		(+DA) 5031 73 /(-DA) 5031 72		5206 H2	
Fourgonnette familiale SN avec pavillon multifonction injection TU3JP	11.00 -> 09.02		5202 GG + 5202 GH		(+DA) 5031 73 /(-DA) 5031 72		5206 H2	
Fourgonnette familiale susp renforcée AV/AR	11.96 -> 09.02		5202 AA + 5202 AC		(+DA) 5031 73 /(-DA) 5031 72		5206 H1	
Susp réhaussée	11.96 -> 09.02		5202 R7 + 5202 R8		(+DA) 5031 73 /(-DA) 5031 72		5206 H1	
Moteur électrique SA18	02.98 -> 09.02		5202 V4 + 5202 V5		(+DA) 5031 73 /(-DA) 5031 72		5206 N7	

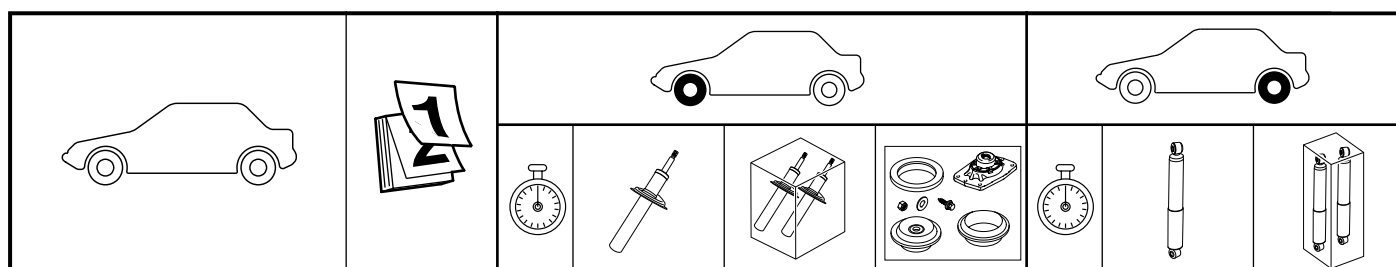

## POUR PEUGEOT

<b>PARTNER ( 02-&gt; )</b>								
TU1JP fourgonnette familiale SN sauf VTC	09.02 ->		5202 GG + 5202 GH		5031 73		5206 V1	
TU3JP fourgonnette familiale SN sauf VTC	09.02 ->		5202 GG + 5202 GH		5031 73		5206 V1	
TU5JP4 fourgonnette familiale SN sauf VTC	09.02 ->		5202 GQ + 5202 GP		5031 73		5206 H2	
DW8B fourgonnette familiale SN sauf VTC	09.02 ->		5202 GQ + 5202 GP		5031 73		5206 H2	
DW10TD fourgonnette familiale SN sauf VTC	09.02 ->		5202 GQ + 5202 GP		5031 73		5206 H2	
Suspension renforcée AV/AR	09.02 ->		5202 JP + 5202 JV		5031 73			
Fourgon court '500' moteur élec SA18	09.02 ->		5202 V4 + 5202 V5		5031 73		5206 H1	
Fourgon court '600' suspension normale	09.02 ->		5202 GG + 5202 GH		5031 73		5206 H1	
Fourgon court '800' suspension normale	09.02 ->		5202 GG + 5202 GH		5031 73		5206 H1	

## POUR RENAULT

<b>R 5 / SUPER 5</b>								
R 5 (B,C,S) sauf GT Turbo / GTE	09.84 -> 05.88	195		5204 09	5030 25	60		5204 85
R 5 (B,C,S) sauf GT Turbo, GTE (embout droit)	06.88 ->	195		5204 09	5030 25	60		5204 85
R 5 (B,C,S) sauf GT Turbo, GTE (embout conique)	06.88 ->	195		5204 14	5030 25	60		5204 85
<b>R 9</b>								
L 421, 422, 423, 424, S, J ( 2 barres de torsion)	1981 ->1990			5204 10	5030 35	60		5204 84
L 42 F/L/N (->Ch.D00000525) (2 barres de torsion)	1981 ->1986			5204 10	5030 35	60		5204 84
L 426 (->Ch.D00003950) ( 2 barres de torsion)	1981 ->1986			5204 10	5030 35	60		5204 84
L 426 (->Ch.H00005600) ( 2 barres de torsion)	1981 ->1986			5204 10	5030 35	60		5204 84
L 42 F/L/N (Ch.D00000526->) (4 barres de torsion)	1986 ->1990			5204 10	5030 35	60		5204 73
L 426 (Ch.D00003951->)	1986 ->1990			5204 10	5030 35	60		5204 73
L 426 (Ch.H00005601->)	1986 ->1990			5204 10	5030 35	60		5204 73
GTE, TURBO (L 42E, L425)	1984 ->1990			5204 10	5030 35	60		5204 73
<b>R 11</b>								
B 371, 372, 373, 374, S, J (2 barres de torsion)	1983 ->1990			5204 10	5030 35	60		5204 84
B 375 (->Ch.D00001343)	1983 -> 1986			5204 10	5030 35	60		5204 84
B 376 (->Ch.D00043789)	1983 -> 1986			5204 10	5030 35	60		5204 84
B 376 (->Ch.H00017726)	1983 -> 1986			5204 10	5030 35	60		5204 84
B 37 F/L/N (->Ch.D00000644)	1983 -> 1986			5204 10	5030 35	60		5204 84
C 371, 372, 373, 374, S, J	1983 -> 1990			5204 10	5030 35	60		5204 84
C 375 (->Ch.D00007886)	1984 -> 1986			5204 10	5030 35	60		5204 84
C 375 (->Ch.E00002300)	1984 -> 1986			5204 10	5030 35	60		5204 84
C 376 (->Ch.D00006418)	1984 -> 1986			5204 10	5030 35	60		5204 84
C 37 F/L/N (->Ch.D00000509)	1984 -> 1986			5204 10	5030 35	60		5204 84



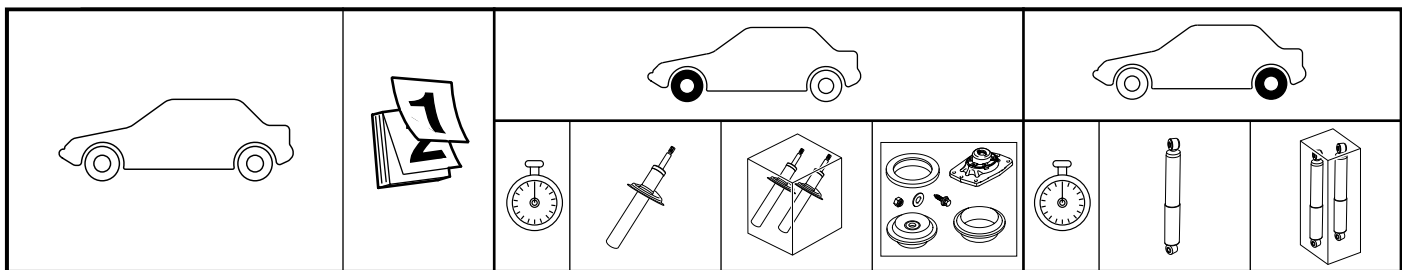

### POUR RENAULT

#### R 11

S 371, 372, 373, 374, 375	1984 -> 1990			5204 10	5030 35	60		5204 84
B 375 (Ch.D00001344->) (4 barres de torsion)	1986 -> 1990			5204 10	5030 35	60		5204 73
B 376 (Ch.D 00043790->)	1986 -> 1990			5204 10	5030 35	60		5204 73
B 376 (Ch.H 00017727->)	1986 -> 1990			5204 10	5030 35	60		5204 73
B 37 F/L/N (Ch.D 00000645->)	1986 -> 1990			5204 10	5030 35	60		5204 73
B 37E, C37E	1986 -> 1990			5204 10	5030 35	60		5204 73
C 375 (Ch.D 00007887->)	1986 -> 1990			5204 10	5030 35	60		5204 73
C 375 (Ch.E 00002301->)	1986 -> 1990			5204 10	5030 35	60		5204 73
C 376 (Ch.D 00006419->)	1986 - 1990			5204 10	5030 35	60		5204 73
C 37 F/L/N (Ch.D00000510->)	1986 -> 1990			5204 10	5030 35	60		5204 73

#### R 19

tous modèles (2 barres de torsion) sauf 16V, cabriolet ,B530/W/1/2, C530/1/2,	05.88 -> 1996	145		5204 13	5030 29	60		5204 81
tous modèles (4 barres de torsion) sauf S530, L530/9	05.88 -> 1996	145		5204 13	5030 29	60		5204 67
cabriolet sauf 16V	1992 ->	145		5204 13	5030 29	60		5204 67
cabriolet 16V	1992 ->					60		5204 67

#### R 21





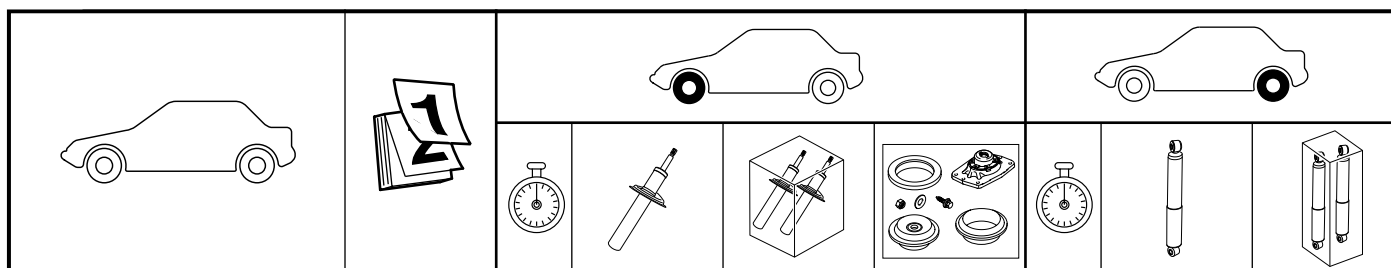

berline L, TL, GTL (B/L 481)	1986 -> 1994	195		5204 45	5030 27			5204 83
berline TL, GTL (B48D,E)	1986 -> 1994	195		5204 45	5030 27			5204 83
berline TL, GTL (L48D)	1986 -> 1994	195		5204 45	5030 27			5204 83
berline TL, GTL (B48F,M)	1986 -> 1994	195		5204 45	5030 27			5204 83
berline TL, GTL, TS, GTS (L48E,F)	1986 -> 1994	195		5204 45	5030 27			5204 83
berline TL, GTL, RS, GTS (L48M,N)	1986 -> 1994	195		5204 45	5030 27			5204 83
berline RS,TS, GTS, TSE (B/L 482)	1986 -> 1994	195		5204 45	5030 27			5204 83
berline GTS (B48N)	1986 -> 1994	195		5204 45	5030 27			5204 83
berline SD, GSD (B/L 48H)	1986 -> 1994	195		5204 45	5030 27			5204 83
berline TX, GTX,GTS (L48J)	1986 -> 1994	195		5204 45	5030 27			5204 83
berline RX,TI, TL, GTX, TXE (L48K)	1986 -> 1989	195		5204 50	5030 33			5204 83
berline RX, TI,TL (4x2, B/L48K) direction manuelle	1989 -> 1994	195		5204 50	5030 33			5204 83
berline GTX, TXE (4x2, B/L48K) direction manuelle	1989 -> 1994	195		5204 50	5030 33			5204 83
berline RX, TI, GTX, TXE (L483/489)	1986 -> 1989	195		5204 50	5030 33			5204 83
berline RX, TI, GTX, TXE (B/L 483/489) direction manuelle	1989 -> 1994	195		5204 50	5030 33			5204 83
berline GTX, TXE (L48S)	1986 -> 1989	195		5204 50	5030 33			5204 83
berline TD, GTD (L486)	1986 -> 1989	195		5204 50	5030 33			5204 83
berline TD, GTD (B/L 486) direction manuelle	1989 -> 1994	195		5204 50	5030 33			5204 83
berline TBD, TDX (L488)	1986 -> 1989	195		5204 50	5030 33			5204 83
berline TBD, TDX (B/L 488/48L) direction manuelle	1989 -> 1994	195		5204 50	5030 33			5204 83





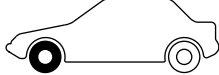
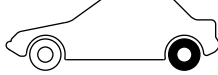

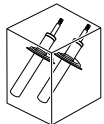
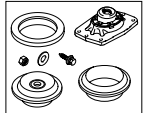

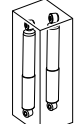

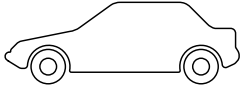

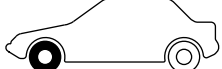
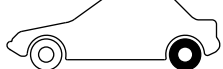

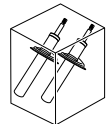
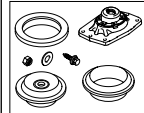

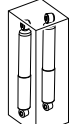

## POUR RENAULT

<b>CLIO I</b>							
1.1 RL/RN (B/C/S 571)	1989 -> 12.93	145		5204 26	5030 26		5204 78
1.1 RC (3/5 57-)	01.94 -> 05.97	145		5204 26	5030 26		5204 78
1.2 RL/RN/RT/NRJ (B/C/S 572)	1989 -> 05.97	145		5204 26	5030 26		5204 78
1.2 RL/RN/RT (B/C/S 57A/57R)	1989 -> 09.92	145		5204 22	5030 26		5204 78
1.2 RL/RN/RT (B/C/S 57A/57R) sauf Auto	10.92 -> 12.93	145		5204 26	5030 26		5204 78
1.2 Automatic	10.92 -> 12.93	145		5204 22	5030 26		5204 78
1.2 RL/RN/RT (B/C/S 57L)	1989 -> 12.93	145		5204 22	5030 26		5204 78
1.2 RL (B 57L)	01.94 -> 05.97	145		5204 22	5030 26		5204 78
1.2 RL/RN/RT/Be Bop (B/C/S 57A)	01.94 -> 05.97	145		5204 26	5030 26		5204 78
1.2 RN/RT (B/C/S 57R/57S)	01.94 -> 05.97	145		5204 26	5030 26		5204 78
1.2 (C/S 572)	01.94 -> 05.97	145		5204 26	5030 26		5204 78
1.4 RL/RN/RT/ Baccara/Automatic(B/C 57B)	1989 -> 09.92			5204 22	5030 26		5204 78
1.4 RN/RT/Baccara/ Automatic(B/C 573/57T)	1989 -> 09.92			5204 22	5030 26		5204 78
1.4 RL/RN/RT/ Baccara(B/C 57B) sauf Auto	10.92 -> 12.93	145		5204 26	5030 30		5204 78
1.4 RN/RT/ Bac. (B/C 573/57T) sauf Auto	10.92 -> 12.93	145		5204 26	5030 30		5204 78
1.4 Automatic	10.92 -> 12.93	145		5204 22	5030 30		5204 78
1.4 S (B/C 57B, C 57T, C 573)	1989 -> 12.93	145		5204 22	5030 30		5204 78
1.4 RTi (C 57B, C 57T)	1989 -> 12.93	145		5204 22	5030 30		5204 78
1.4 RL/RN/RT (C 57B) sauf Auto.	01.94 -> 05.97	145		5204 26	5030 30		5204 78
1.4 RN/RT/Be Bop (B/C 57T) sauf Auto.	01.94 -> 05.97	145		5204 26	5030 30		5204 78
1.4 RL/RN/RT/Be Bop(B/C 57Y)	01.94 -> 05.97	145		5204 26	5030 30		5204 78
1.4 sauf Automatic (C 573)	01.94 -> 05.97	145		5204 26	5030 30		5204 78
1.4 RL/RT/Be Bop (B/C/S 577)	01.94 -> 05.97	145		5204 26	5030 30		5204 78
1.4 RL/RN/RT (B/5 57B)	01.94 -> 05.97	145		5204 22	5030 30		5204 78
1.4 S, RTi (C 57B)	01.94 -> 05.97	145		5204 22	5030 30		5204 78
1.4 Automatic (C 573/57B/57T)	01.94 -> 05.97	145		5204 22	5030 30		5204 78
1.7 RT/Baccara (B/C 574)	1989 -> 12.93	145		5204 22	5030 30		5204 78
1.8 RT/Baccara (B/C 57C)	1989 -> 12.93	145		5204 22	5030 30		5204 78
1.8 RT (B 57C)	01.94 -> 05.97	145		5204 22	5030 30		5204 78
1.8 RT/Baccara (557D, B578)	01.94 -> 05.97	145		5204 22	5030 30		5204 78
1.9D (B/C/S 571, B/S 576)	1989 -> 12.93	145		5204 22	5030 30		5204 78
1.9D (B/C 57U)	1989 -> 12.93	145		5204 22	5030 30		5204 78
1.9D (3 portes, C571/S571)	01.94 -> 05.97	145		5204 26	5030 30		5204 78
1.9D (5 portes, B571)	01.94 -> 05.97	145		5204 22	5030 30		5204 78
tous modèles	05.97 -> 03.98				5030 30		5204 78
<b>CLIO II</b>							
sauf 2,0	03.98 ->				5030 34		
<b>ESPACE</b>							
J 112 (->Ch.T005812)	1984 -> 12.84					60	5204 69
J112 (Ch.T005813 -> T036434)	01.85 -> 12.87	150		5204 29		60	5204 69
S 112 (->Ch.T000620)	01.85 -> 12.87	150		5204 29		60	5204 69
J 117 (->Ch.T003258)	01.85 -> 12.87	150		5204 29		60	5204 69
J 115 (->Ch.T020896)	01.85 -> 12.87	150		5204 29		60	5204 69
S 115 (->Ch.T000841)	01.85 -> 12.87	150		5204 29		60	5204 69

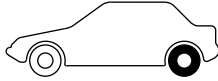
								
								
<b>POUR RENAULT</b>								
<b>ESPACE</b>								
J 112 (Ch.T036435->) sauf suspension pneumatique	01.88 -> 1991	150		<b>5204 35</b>		60		<b>5204 69</b>
J 112 (Ch.K000001->) sauf suspension pneumatique	01.88 -> 1991	150		<b>5204 35</b>		60		<b>5204 69</b>
S 112 (Ch.T000621->) sauf suspension pneumatique	01.88 -> 1991	150		<b>5204 35</b>		60		<b>5204 69</b>
J 116 (Ch.T000001->) sauf suspension pneumatique	01.88 -> 1991	150		<b>5204 35</b>		60		<b>5204 69</b>
J 116 (Ch.K000001->) sauf suspension pneumatique	01.88 -> 1991	150		<b>5204 35</b>		60		<b>5204 69</b>
J 117 (Ch.T003259->) sauf suspension pneumatique	01.88 -> 1991	150		<b>5204 35</b>		60		<b>5204 69</b>
J 115 (Ch.T020897->) sauf suspension pneumatique	01.88 -> 1991	150		<b>5204 35</b>		60		<b>5204 69</b>
S 115 (Ch.T000842->) sauf suspension pneumatique	01.88 -> 1991	150		<b>5204 35</b>		60		<b>5204 69</b>
tous modèles (J63...) sauf V6,Quadra, suspension pneumatique	1991 -> 1996	150		<b>5204 35</b>		60		<b>5204 69</b>
V6 (J638) sauf Quadra, suspension pneumatique	1991 -> 1996					60		<b>5204 69</b>
<b>EXPRESS / EXTRA / RAPID / COMBI</b>								
utilitaire (4 barres de torsion) sauf CU+ (775Kg)	1985 -> 09.96	195		<b>5204 25</b>	<b>5030 25</b>	60		<b>5204 65</b>
utilitaire CU+ (775Kg)	1991 -> 09.96	195		<b>5204 25</b>	<b>5030 25</b>			
utilitaire (4 barres de torsion) sauf CU+ (775Kg)	10.96 ->					60		<b>5204 65</b>
<b>KANGOO</b>								
tous modèles (4 barres de torsion) sauf Pampa, utilitaire	1997 ->			<b>5204 41</b>	<b>5030 34</b>			<b>5204 64</b>
tous modèles Pampa	1997 ->			<b>5204 41</b>	<b>5030 34</b>			
utilitaire (600Kg) (4 barres de torsion) sauf CU+	1997 ->			<b>5204 41</b>	<b>5030 34</b>			<b>5204 64</b>
utilitaire CU+ (800 Kg)	1997 ->			<b>5204 41</b>	<b>5030 34</b>			
<b>LAGUNA</b>								
berline 1.6 (Ø16)	1999 -> 2000	130		<b>5204 38</b>	<b>5030 28</b>	45		<b>5204 88</b>
berline 1.8 RN/RT/RXE (B56 A/B/S/Z) (Ø16)	12.93 -> 02.95	130		<b>5204 38</b>	<b>5030 28</b>	45		<b>5204 88</b>
berline 1.9dti (Ø16)	1998 -> 2000	130		<b>5204 38</b>	<b>5030 28</b>	45		<b>5204 88</b>
berline 2.0 RT/RXE/Baccara (B56C/B56H) (Ø16)	12.93 -> 02.95	130		<b>5204 38</b>	<b>5030 28</b>	45		<b>5204 88</b>
berline 2.2D/TD RN/RT/RXE (B56F/B562) (Ø16)	12.93 - 2000	130		<b>5204 38</b>	<b>5030 28</b>	45		<b>5204 88</b>
berline 3.0 V6 RT/RTI/Baccara (B56E/B56R) (Ø16)	12.93 -> 2000	130		<b>5204 38</b>	<b>5030 28</b>	45		<b>5204 88</b>
berline 1.6 (Ø14)	1999 -> 2000	130		<b>5204 37</b>	<b>5030 28</b>	45		<b>5204 88</b>
berline 1.8 RN/RT/RXE (B56 A/B/S/Z) (Ø14)	02.95 -> 2000	130		<b>5204 37</b>	<b>5030 28</b>	45		<b>5204 88</b>
berline 1.8 RN/RT (B56T/B560) sauf ABS (Ø14)	02.95 -> 2000	130		<b>5204 37</b>	<b>5030 28</b>	45		<b>5204 88</b>
berline 2.0 (B56L) sauf ABS, Auto. (Ø14)	02.95 -> 2000	130		<b>5204 37</b>	<b>5030 28</b>	45		<b>5204 88</b>

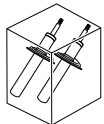
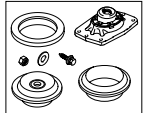
								
								
<b>POUR RENAULT</b>								
<b>LAGUNA</b>								
berline 2.0 (B56C/B56H) sauf ABS (Ø14)	02.95 -> 2000	130		<b>5204 37</b>	<b>5030 28</b>	45		<b>5204 88</b>
berline 1.8 RN/RT ABS (B56T/B560) (Ø16)	02.95 -> 2000	130		<b>5204 38</b>	<b>5030 28</b>	45		<b>5204 88</b>
berline 2.0 ABS, Auto. (B56L) (Ø16)	02.95 -> 2000	130		<b>5204 38</b>	<b>5030 28</b>	45		<b>5204 88</b>
berline 2.0 RN/RT/RXE/RTI (B56D/B56M) (Ø16)	02.95 -> 2000	130		<b>5204 38</b>	<b>5030 28</b>	45		<b>5204 88</b>
berline 2.0 ABS (B56C/B56H) (Ø16)	02.95 -> 2000	130		<b>5204 38</b>	<b>5030 28</b>	45		<b>5204 88</b>
break Nevada (Ø16) sauf V6, suspension pilotée	1995 -> 2000			<b>5204 38</b>	<b>5030 28</b>			
break Nevada (Ø16) V6 sauf suspension pilotée	1995 -> 2000			<b>5204 38</b>	<b>5030 28</b>			
<b>MEGANE</b>								
5P (5portes) sauf 2.0i-16V	09.95 ->	100		<b>5204 34</b>	<b>5030 31</b>	35		<b>5204 89</b>
berline (Classic, 4portes) sauf suspension pilotée	09.96 ->	100		<b>5204 34</b>	<b>5030 31</b>	35		<b>5204 89</b>
break	1998 -> 06.99	100		<b>5204 34</b>	<b>5030 31</b>			
coupé 3P (3portes) sauf 2.0i-16V	09.95 ->	100		<b>5204 34</b>	<b>5030 31</b>	35		<b>5204 89</b>
cabriolet sauf 2.0	09.95 ->	100		<b>5204 34</b>	<b>5030 31</b>			
<b>MEGANE SCENIC</b>								
Scenic 1.4i	11.96 -> 06.98	100		<b>5204 34</b>	<b>5030 31</b>	35		<b>5204 90</b>
Scenic 1.6i sauf Auto.	11.96 -> 06.98	100		<b>5204 34</b>	<b>5030 31</b>	35		<b>5204 90</b>
Scenic 1.6i Auto.	11.96 -> 06.98	100		<b>5204 61</b>	<b>5030 31</b>	35		<b>5204 90</b>
Scenic 1.9D	11.96 -> 06.98	100		<b>5204 61</b>	<b>5030 31</b>	35		<b>5204 90</b>
Scenic 1.9TD, Dti	11.96 -> 06.98	100		<b>5204 61</b>	<b>5030 31</b>	35		<b>5204 90</b>
Scenic 2.0i	11.96 -> 06.98	100		<b>5204 61</b>	<b>5030 31</b>	35		<b>5204 90</b>
Scenic tous modèles	06.98 ->	100		<b>5204 34</b>	<b>5030 31</b>	35		<b>5204 90</b>
<b>SAFRANE</b>								
tous modèles sauf 4x4, suspension pilotée	1992 -> 1996	180		<b>5204 40</b>	<b>5030 32</b>	180		<b>5204 95</b>
tous modèles	1996 ->	180		<b>5204 40</b>	<b>5030 32</b>	180		<b>5204 95</b>
<b>TWINGO</b>								
tous modèles	1993 -> 10.98			<b>5204 33</b>	<b>5030 26</b>			<b>5204 A3</b>
tous modèles	11.98 -> 08.00							<b>5204 A3</b>
<b>POUR SEAT</b>								
<b>ALHAMBRA</b>								
Tous modèles	09.96 ->				<b>5030 39</b>			
<b>AROSA</b>								
tous modèles	1997 ->			<b>5204 54</b>	<b>5030 43</b>			
<b>CORDOBA</b>								
tous modèles sauf 1.8-16V, 2.0 GTI	10.93 -> 12.95	120		<b>5204 47</b>	<b>5030 36</b>			
tous modèles sauf 1.8-16V, 2.0 GTI	01.96 -> 06.99	120		<b>5204 47</b>	<b>5030 39</b>			
break (Vario)	1997 ->			<b>5204 47</b>	<b>5030 39</b>			
<b>IBIZA</b>								
tous modèles	09.89 -> 1993	100		<b>5204 51</b>	<b>5030 41</b>	70		<b>5204 93</b>
Mot AAU / ABD / ABS / ADZ / 1Y / AAZ	02.93 -> 12.95	120		<b>5204 47</b>	<b>5030 36</b>			

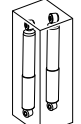
											
											
<b>POUR SEAT</b>											
<b>IBIZA</b>											
Mot AAU / ABD / ADZ / 1Y / AAZ	01.96 -> 08.99	120			<b>5204 47</b>	<b>5030 39</b>					
Mot 1F / AEE	03.93 -> 04.96	120			<b>5204 47</b>	<b>5030 36</b>					
Mot 1F / AEE / AFT	05.96 -> 08.99	120			<b>5204 47</b>	<b>5030 39</b>					
Mot AEX / AEY	09.93 -> 01.96	120			<b>5204 47</b>	<b>5030 39</b>					
Mot AAV / ABU / 2G	02.93 -> 07.94	120			<b>5204 47</b>	<b>5030 36</b>					
<b>INCA</b>											
utilitaire	1995 ->				<b>5204 54</b>	<b>5030 39</b>					
<b>LEON</b>											
tous modèles	10.99 ->					<b>5030 42</b>					
<b>MALAGA / CREDOS</b>											
tous modèles	09.89 ->	100			<b>5204 51</b>	<b>5030 41</b>	70			<b>5204 93</b>	
<b>MARBELLA</b>											
tous modèles	1987 -> 03.89	70			<b>5204 18</b>	<b>5030 06</b>					
<b>PANDA</b>											
tous modèles	1980 ->	70			<b>5204 18</b>	<b>5030 06</b>					
<b>TERRA</b>											
utilitaire	1987 -> 03.89	70			<b>5204 18</b>	<b>5030 06</b>					
<b>TOLEDO I</b>											
1.6, 1.9D, 1.9TD	03.91 -> 10.96	60			<b>5204 47</b>	<b>5030 36</b>	50			<b>5204 97</b>	
1.6, 1.9D, 1.9TD	11.96 ->	60			<b>5204 47</b>	<b>5030 39</b>	50			<b>5204 97</b>	
<b>TOLEDO II</b>											
tous modèles	04.99 ->					<b>5030 42</b>					
<b>TRANS</b>											
tous modèles	1985 ->	70			<b>5204 18</b>						
<b>POUR SKODA</b>											
<b>OCTAVIA</b>											
berline 1.6i	10.96 ->				<b>5204 60</b>	<b>5030 42</b>				<b>5204 62</b>	
berline 1.9 TDi-90	10.96 ->				<b>5204 60</b>	<b>5030 42</b>				<b>5204 62</b>	
berline 1.8i	10.96 ->									<b>5204 62</b>	
break 4x2	1997 ->				<b>5204 60</b>	<b>5030 42</b>					
break 4x4	1997 ->				<b>5204 60</b>	<b>5030 42</b>					
<b>POUR VAUXHALL</b>											
<b>ASTRA - BELMONT</b>											
berline	1980 -> 1984	140			<b>5204 05</b>	<b>5030 14</b>					
break	1980 -> 1984	140			<b>5204 05</b>	<b>5030 14</b>					
berline 1.2, 1.3, 1.4, 1.6 (->Ch.J2791967) sauf GSi/GTE	1984 -> 07.88	140			<b>5204 05</b>	<b>5030 14</b>					
berline 1.2, 1.3, 1.4, 1.6 (->Ch.J5273427) sauf GSi/GTE	1984 -> 07.88	140			<b>5204 05</b>	<b>5030 14</b>					
berline 1.2, 1.3, 1.4, 1.6 (Ch.J2791968->) sauf GSi/GTE	08.88 -> 08.91	140			<b>5204 05</b>	<b>5030 14</b>	25			<b>5204 72</b>	
berline 1.2, 1.3, 1.4, 1.6 (Ch.J5273428->) sauf GSi/GTE	08.88 -> 08.91	140			<b>5204 05</b>	<b>5030 14</b>	25			<b>5204 72</b>	
break	1984 -> 08.91	140			<b>5204 05</b>	<b>5030 14</b>					
berline sauf GT, GSi	09.91 -> 1998	150			<b>5204 02</b>	<b>5030 15</b>	40			<b>5204 72</b>	
break	09.91 -> 1998	150			<b>5204 02</b>	<b>5030 15</b>					
<b>CALIBRA</b>											
2.0i, 2.0i-16V, 2.5 V6 sauf Turbo, suspension pilotée	1990 ->	145			<b>5204 03</b>	<b>5030 16</b>					

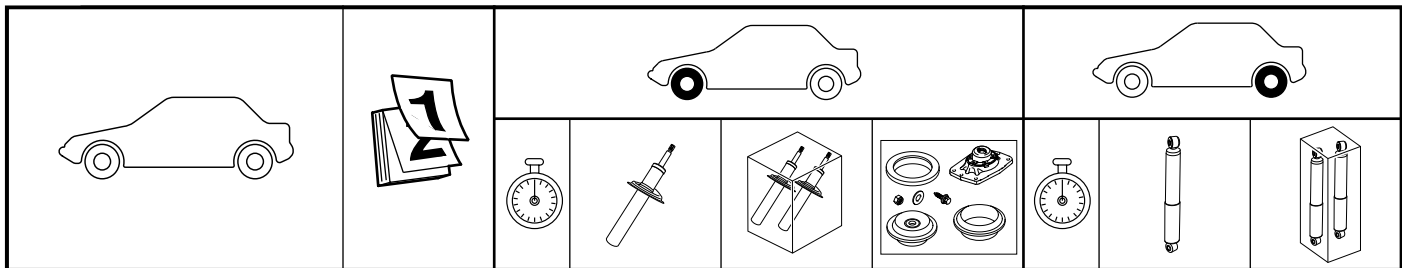

## POUR VAUXHALL

### CAVALIER

1.4, 1.4i, 1.6, 1.6i, 1.7D sauf 4x4	09.88 -> 1995	145		5204 03	5030 16	40		5204 72
1.7TD, 1.8, 1.8i, 2.0i sauf 4x4	09.88 -> 1995	145		5204 03	5030 16	40		5204 72
1.8 4x4, 2.0i 4x4	09.88 -> 1995	145		5204 03	5030 16			
2.0i-16V 4x4 sauf Turbo	09.88 -> 1995	145		5204 03	5030 16			
2.0i-16V (-> Ch.NV199999) sauf 4x4	09.88 -> 1992	145		5204 03	5030 16			
2.0i-16V (-> Ch.N1999999) sauf 4x4	09.88 -> 1992	145		5204 03	5030 16			
2.0i-16V (-> Ch.N5999999) sauf 4x4	09.88 -> 1992	145		5204 03	5030 16			
2.0i-16V (Ch.NV199999->) sauf 4x4	1993 -> 1995	145		5204 03	5030 16	40		5204 72
2.0i-16V (Ch.N199999->) sauf 4x4	1993 -> 1995	145		5204 03	5030 16	40		5204 72
2.0i-16V (Ch.N599999->) sauf 4x4	1993 -> 1995	145		5204 03	5030 16	40		5204 72

### CORSA (NOVA)

tous modèles sauf GSI	1993 ->	150		5204 30	5030 13	50		5204 87
-----------------------	---------	-----	--	---------	---------	----	--	---------

### NOVA

tous modèles sauf GT	1983 -> 1993	150		5204 12		50		5204 80
----------------------	--------------	-----	--	---------	--	----	--	---------

## POUR VOLKSWAGEN

### BORA

berline sauf VR5, Sport susp.	1998 ->	80		5204 60	5030 42			
break sauf VR5, Sport susp., 4x4	1998 ->	80		5204 60	5030 42			

### CADDY

utilitaire (Caddy)	1995 ->			5204 54	5030 39			
--------------------	---------	--	--	---------	---------	--	--	--

### CORRADO

sauf Mot 2,9L (ABV)	04.89 -> 07.94				5030 38			
Mot ABV	08.91 -> 07.94				5030 39			
	08.94 ->				5030 39			

### DERBY







tous modèles	1977 -> 1986	155		5204 08	5030 37	55		5204 79
--------------	--------------	-----	--	---------	---------	----	--	---------

### GOLF II

tous modèles (suspension normale) sauf GTI 16V, G60, Syncro	09.83 -> 1989	100		5204 07	5030 36	40		5204 97
Syncro sauf Country	1986 -> 1989			5204 07	5030 36			
tous modèles sauf GTI 16V, G60, Syncro, Country	1990 -> 08.91	100		5204 07	5030 36	40		5204 97
Syncro, sauf Country, Rallye	1990 -> 08.91			5204 47	5030 36			

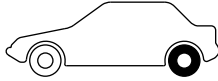
### GOLF III

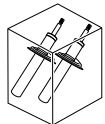
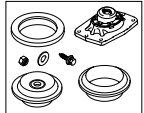
berline essence sauf GT, GTI, VR6	09.91 -> 08.94	120		5204 47	5030 36	60		5204 97
berline essence sauf GT, GTI, VR6	09.94 -> 06.95			5204 54	5030 36	60		5204 97
berline essence sauf GT, GTI, VR6	06.95 -> 1998			5204 54	5030 39	60		5204 97
berline 1,9D TD TDi sauf GT, GTI	09.91 -> 08.94	120		5204 47	5030 38	60		5204 97
berline 1,9D TD TDi sauf GT, GTI	09.94 -> 06.95			5204 54	5030 38	60		5204 97

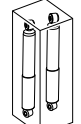
									
									
									
<b>POUR VOLKSWAGEN</b>									
<b>GOLF III</b>									
berline 1,9D TD TDi sauf GT, GTI	06.95 -> 1998			<b>5204 54</b>	<b>5030 39</b>	60			<b>5204 97</b>
berline 1.8 Syncro	01.93 -> 08.94	120		<b>5204 47</b>	<b>5030 36</b>				
berline 1.8 Syncro	09.94 -> 1998			<b>5204 54</b>	<b>5030 36</b>				
break Essence sauf 2.0 GL/GLT	09.91 -> 08.94	120		<b>5204 47</b>	<b>5030 36</b>				
break Essence sauf 2.0 GL/GLT	09.94 -> 06.95			<b>5204 54</b>	<b>5030 36</b>				
break Essence sauf 2.0 GL/GLT	06.95 -> 1998			<b>5204 54</b>	<b>5030 39</b>				
break Diesel	09.91 -> 08.94	120		<b>5204 47</b>	<b>5030 38</b>				
break Diesel	09.94 -> 06.95			<b>5204 54</b>	<b>5030 38</b>				
break Diesel	06.95 -> 1998			<b>5204 54</b>	<b>5030 39</b>				
cabriolet 1.6, 1.8, 1.9TDi	09.93 -> 08.94	120		<b>5204 47</b>	<b>5030 39</b>	60			<b>5204 97</b>
cabriolet 1.6, 1.8, 1.9TDi	09.94 ->			<b>5204 54</b>	<b>5030 39</b>	60			<b>5204 97</b>
<b>GOLF IV</b>									
berline 1.4, 1.6, 1.9D, 1.9TDi sauf sport susp., 4x4	1997 ->			<b>5204 60</b>	<b>5030 42</b>				<b>5204 62</b>
break 1.4, 1.6, 1.9D, 1.9TDi sauf sport susp.	1997 ->			<b>5204 60</b>	<b>5030 42</b>				
<b>JETTA</b>									
tous modèles (suspension normale) sauf GLI/CLI, 16V, Syncro, H.D.	08.83 -> 1988	100		<b>5204 07</b>	<b>5030 36</b>	40			<b>5204 97</b>
Syncro	1986 -> 1989			<b>5204 07</b>	<b>5030 36</b>				
tous modèles sauf GTI, GTI 16V, Syncro (Cartouche Mac Pherson)	1989 -> 1992	100		<b>5204 07</b>	<b>5030 36</b>	40			<b>5204 97</b>
tous modèles sauf GTI, GTI 16V, Syncro (Jambe de force Mac Pherson)	1989 -> 1992	100		<b>5204 47</b>	<b>5030 36</b>	40			<b>5204 97</b>
Syncro	1990 - 1992			<b>5204 47</b>	<b>5030 36</b>				
<b>LUPO</b>									
tous modèles sauf Sdi, TDi	1998 ->	55		<b>5204 54</b>	<b>5030 43</b>				
<b>NEW BEETLE</b>									
tous modèles	1998 ->				<b>5030 42</b>				
<b>PASSAT</b>									
berline, break (sauf Syncro)	10.80 -> 1988	195		<b>5204 04</b>	<b>5030 40</b>	70			<b>5204 01</b>
berline sauf Syncro, VR6	1988 -> 07.91			<b>5204 52</b>	<b>5030 38</b>	60			<b>5204 96</b>
break sauf Syncro, VR6, suspension pneumatique	1988 -> 07.91			<b>5204 52</b>	<b>5030 38</b>	60			<b>5204 96</b>
berline Syncro sauf suspension pneumatique	1989 -> 07.91			<b>5204 52</b>	<b>5030 38</b>				
break Syncro sauf suspension pneumatique	1989 -> 07.91			<b>5204 52</b>	<b>5030 38</b>				
berline sauf Syncro, VR6, suspension pneumatique (->Ch.026435)	08.91 -> 08.92	100		<b>5204 52</b>	<b>5030 38</b>	60			<b>5204 96</b>
berline sauf Syncro, VR6, suspension pneumatique (Ch.026436 ->)	08.92 -> 1996				<b>5030 39</b>	60			<b>5204 96</b>
berline Syncro sauf suspension pneumatique (->Ch.026435)	08.91 -> 08.92	100		<b>5204 52</b>	<b>5030 38</b>				



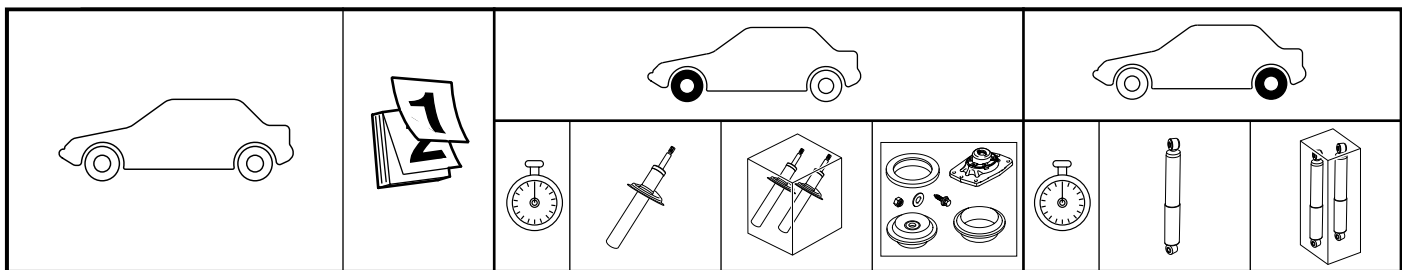

## POUR VOLKSWAGEN

### PASSAT

break sauf Syncro, VR6, suspension pneumatique ( ->Ch.026435)	08.91 -> 08.92	100		<b>5204 52</b>	<b>5030 38</b>	60		<b>5204 96</b>
break sauf Syncro, VR6, suspension pneumatique ( Ch.026436->)	08.92 -> 1996				<b>5030 39</b>	60		<b>5204 96</b>
break Syncro (->Ch.026 435) sauf suspension pneumatique	08.91 -> 08.92	100		<b>5204 52</b>	<b>5030 38</b>			

### POLO

tous modèles sauf G40	1974 -> 08.94	155		<b>5204 08</b>	<b>5030 37</b>	55		<b>5204 79</b>
1.05, 1.3, 1.6, 1.9D (3/5 portes)	09.94 ->	55		<b>5204 54</b>	<b>5030 43</b>	55		<b>5204 76</b>
1.05, 1.3, 1.6, 1.9D Classic/Flight (4 portes)	09.94 ->	55		<b>5204 54</b>	<b>5030 43</b>			
break Variant	1997 ->			<b>5204 54</b>	<b>5030 43</b>			
utilitaire (Caddy)	1995 ->			<b>5204 54</b>	<b>5030 39</b>			

### SANTANA

tous modèles	1982 -> 1986	195		<b>5204 04</b>	<b>5030 40</b>	100		<b>5204 01</b>
--------------	--------------	-----	--	----------------	----------------	-----	--	----------------

### SHARAN









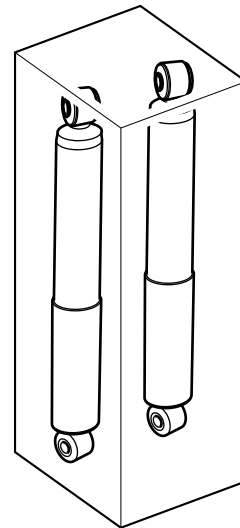
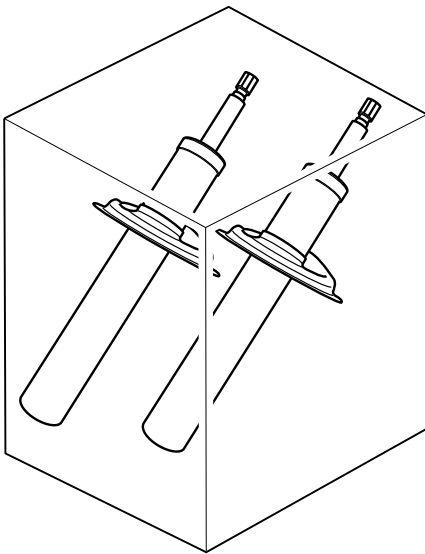

tous modèles	09.95 ->				<b>5030 39</b>			
--------------	----------	--	--	--	----------------	--	--	--







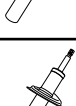
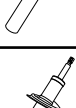
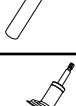
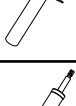
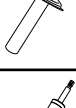
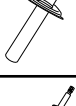



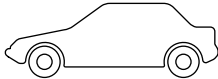

### VENTO





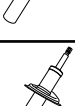
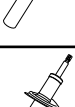
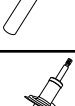

berline essence sauf GT, GTI, VR6	09.91 -> 08.94	120		<b>5204 47</b>	<b>5030 36</b>	60		<b>5204 97</b>
berline essence sauf GT, GTI, VR6	09.94 -> 06.95			<b>5204 54</b>	<b>5030 36</b>	60		<b>5204 97</b>
berline essence sauf GT, GTI, VR6	06.95 -> 1998			<b>5204 54</b>	<b>5030 39</b>	60		<b>5204 97</b>
berline 1,9D TD TDi sauf GT, GTI	09.91 -> 08.94	120		<b>5204 47</b>	<b>5030 38</b>	60		<b>5204 97</b>
berline 1,9D TD TDi sauf GT, GTI	09.94 - 06.95			<b>5204 54</b>	<b>5030 38</b>	60		<b>5204 97</b>
berline 1,9D TD TDi sauf GT, GTI	06.95 - 1998			<b>5204 54</b>	<b>5030 39</b>	60		<b>5204 97</b>

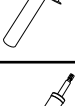

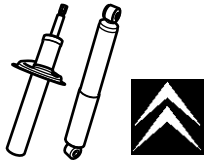

- 2 - TRI PAR REFERENCES**
- LISTED BY PART NUMBERS
  - CLASIFICADO POR REFERENCIAS
  - TRI POR REFERENCIAS
  - GEORDNET NACH REFERENZEN
  - ORDINE PER RIFERIMENTI
  - OP REFERENTIE'S VOLGORDE

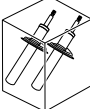
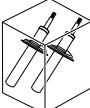
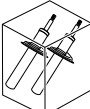
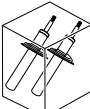
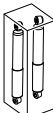
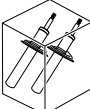
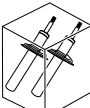
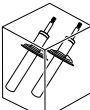
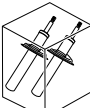
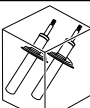
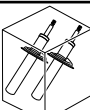

		 <b>Pour/For/Para/Für/Per/Voor</b>
96085227		PEUGEOT 205
5202 AA		PEUGEOT PARTNER ( ->02 )
5202 AC		PEUGEOT PARTNER ( ->02 )
5202 AV		PEUGEOT 306 ( 97-> )
5202 AW		PEUGEOT 306 ( 97-> )
5202 FC		PEUGEOT 106 ( -> 96 )
5202 FF		PEUGEOT 106 ( -> 96 ), 106 ( 96 -> )
5202 FH		PEUGEOT 106 ( -> 96 ), 106 ( 96 -> )
5202 FN		PEUGEOT 106 ( -> 96 ), 106 ( 96 -> )
5202 FY		FIAT ULYSSE R / LANCIA PHEDRA / PEUGEOT 807
5202 FZ		FIAT ULYSSE R / LANCIA PHEDRA / PEUGEOT 807
5202 GG		PEUGEOT PARTNER ( ->02 ), PARTNER ( 02-> )
5202 GH		PEUGEOT PARTNER ( ->02 ), PARTNER ( 02-> )
5202 GQ		PEUGEOT PARTNER ( ->02 ), PARTNER ( 02-> )
5202 GP		PEUGEOT PARTNER ( ->02 ), PARTNER ( 02-> )

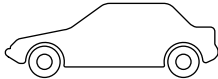
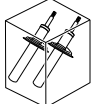
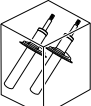
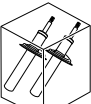
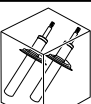
		 <b>Pour/For/Para/Für/Per/Voor</b>
5202 GT		PEUGEOT PARTNER ( ->02 )
5202 GV		PEUGEOT PARTNER ( ->02 )
5202 H1		FIAT ULYSSE / LANCIA ZETA / PEUGEOT 806
5202 J3		PEUGEOT BOXER ( ->01 ), BOXER ( 01-> )
5202 J5		PEUGEOT BOXER ( ->01 )
5202 JA		PEUGEOT BOXER ( 01-> )
5202 JP		PEUGEOT PARTNER ( 02-> )
5202 JV		PEUGEOT PARTNER ( 02-> )
5202 K8		FIAT SCUDO, ULYSSE / LANCIA ZETA / PEUGEOT 806, EXPERT
5202 P9		PEUGEOT 306 ( ->97 ), 306 ( 97-> ) , PARTNER ( ->02 )
5202 Q3		PEUGEOT 306 ( ->97 ), 306 ( 97-> ) , PARTNER ( ->02 )
5202 Q1		PEUGEOT PARTNER ( ->02 )
5202 Q5		PEUGEOT PARTNER ( ->02 )
5202 Q9		PEUGEOT 106 ( 96 -> )
5202 R7		PEUGEOT PARTNER ( ->02 )

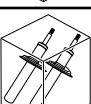

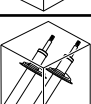
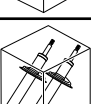
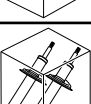
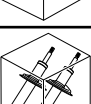
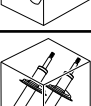
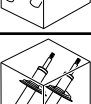
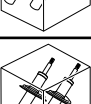
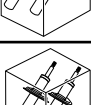
		 <b>Pour/For/Para/Für/Per/Voor</b>
5202 R8		PEUGEOT PARTNER ( ->02 )
5202 V4		PEUGEOT PARTNER ( ->02 ), PARTNER ( 02-> )
5202 V5		PEUGEOT PARTNER ( ->02 ), PARTNER ( 02-> )
<b>5204 01</b>		VOLKSWAGEN PASSAT, SANTANA
<b>5204 02</b>		OPEL ASTRA / VAUXHALL ASTRA - BELMONT
<b>5204 03</b>		OPEL CALIBRA, VECTRA A / VAUXHALL CALIBRA, CAVALLIER
<b>5204 04</b>		AUDI Audi 80, Audi 90, COUPE / VOLKSWAGEN PASSAT, SANTANA
<b>5204 05</b>		BEDFORD ASTRA / DAEWOO ESPERO, LANOS, NEXIA , CIELO / OPEL COMBO, KADETT D, KADETT E / VAUXHALL ASTRA - BELMONT
<b>5204 06</b>		FORD ESCORT III , IV, ORION
<b>5204 07</b>		VOLKSWAGEN GOLF II, JETTA
<b>5204 08</b>		VOLKSWAGEN DERBY, POLO
<b>5204 09</b>		RENAULT R 5 , SUPER 5
<b>5204 10</b>		RENAULT R 9, R 11
<b>5204 11</b>		FIAT UNO
<b>5204 12</b>		OPEL CORSA A / VAUXHALL NOVA

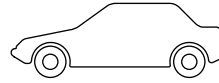
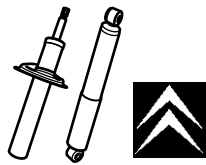
		 <b>Pour/For/Para/Für/Per/Voor</b>
5204 13		RENAULT R 19
5204 14		RENAULT R 5 , SUPER 5
5204 15		FORD FIESTA II
5204 16		FORD ESCORT III , IV, ORION
5204 17		RENAULT R 25
5204 18		FIAT PANDA / SEAT MARBELLA, PANDA, TERRA, TRANS
5204 19		FORD FIESTA III
5204 20		FORD ESCORT III / IV, ORION
5204 21		FORD ESCORT V, ORION
5204 22		RENAULT CLIO
5204 23		FORD SIERRA
5204 24		FORD COURRIER, FIESTA III
5204 25		RENAULT EXPRESS , EXTRA , RAPID , COMBI
5204 26		RENAULT CLIO
5204 27		FORD ESCORT V, ORION





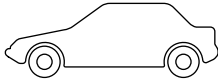
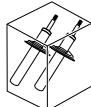
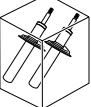
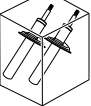
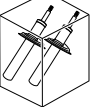
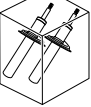
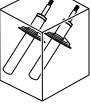
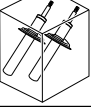
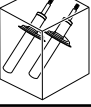
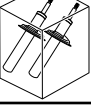
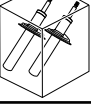
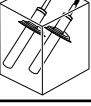
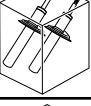
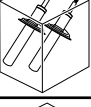
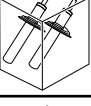





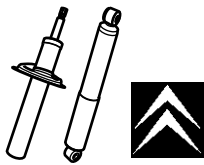
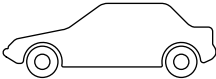
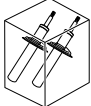
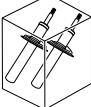
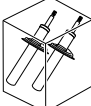
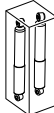

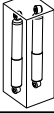
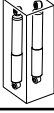
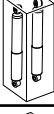
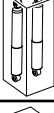
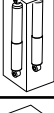
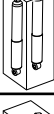
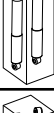
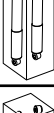
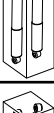

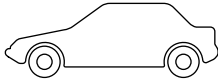
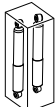
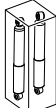
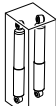
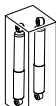
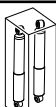

Pour/For/Para/Für/Per/Voor



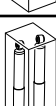

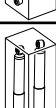

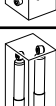

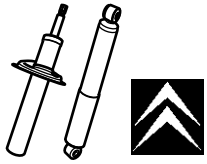

<b>5204 29</b>		RENAULT ESPACE
<b>5204 30</b>		OPEL CORSA B / VAUXHALL CORSA (NOVA)
<b>5204 31</b>		FORD FIESTA III
<b>5204 32</b>		FORD COURRIER, FIESTA III
<b>5204 33</b>		RENAULT TWINGO
<b>5204 34</b>		RENAULT MEGANE, MEGANE SCENIC
<b>5204 35</b>		RENAULT ESPACE
<b>5204 36</b>		PEUGEOT 406
<b>5204 37</b>		RENAULT LAGUNA
<b>5204 38</b>		RENAULT LAGUNA
<b>5204 39</b>		PEUGEOT 605
<b>5204 40</b>		RENAULT SAFRANE
<b>5204 41</b>		RENAULT KANGOO
<b>5204 42</b>		FORD COURRIER, FIESTA IV / MAZDA 121 , REVUE
<b>5204 43</b>		FORD COURRIER, FIESTA IV / MAZDA 121 , REVUE

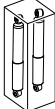
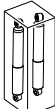
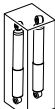
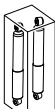
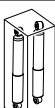
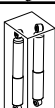
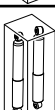









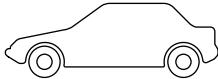
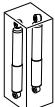



		 <b>Pour/For/Para/Für/Per/Voor</b>
<b>5204 44</b>		PEUGEOT 205, 309
<b>5204 45</b>		RENAULT R 21
<b>5204 46</b>		PEUGEOT 405 ( ->92 ), 405 ( 92 -> )
<b>5204 47</b>		SEAT CORDOBA, IBIZA, TOLEDO / VOLKSWAGEN GOLF II, GOLF III, JETTA, VENTO
<b>5204 48</b>		RENAULT R 21
<b>5204 49</b>		PEUGEOT 405 ( ->92 ), 405 ( 92 -> )
<b>5204 50</b>		RENAULT R 21
<b>5204 51</b>		SEAT IBIZA, MALAGA / CREDOS
<b>5204 52</b>		VOLKSWAGEN PASSAT
<b>5204 53</b>		FIAT BRAVA , BRAVO, TEMPRA, TIPO
<b>5204 54</b>		SEAT AROSA, INCA / VOLKSWAGEN CADDY, GOLF III, LUPO, POLO, VENTO
<b>5204 55</b>		FIAT PUNTO
<b>5204 56</b>		FIAT PUNTO
<b>5204 57</b>		FORD MONDEO
<b>5204 58</b>		FORD ESCORT V



		 <b>Pour/For/Para/Für/Per/Voor</b>
<b>5204 59</b>		FIAT BRAVA / BRAVO
<b>5204 60</b>		SKODA OCTAVIA / VOLKSWAGEN BORA, GOLF IV
<b>5204 61</b>		RENAULT MEGANE SCENIC
<b>5204 62</b>		AUDI A3 / SKODA OCTAVIA / VOLKSWAGEN GOLF IV
<b>5204 63</b>		AUDI Audi 80, Audi 90, COUPE
<b>5204 64</b>		RENAULT KANGOO
<b>5204 65</b>		RENAULT EXPRESS , EXTRA , RAPID , COMBI
<b>5204 66</b>		ALFA ROMEO 145 , 146 / FIAT TEMPRA, TIPO / LANCIA DELTA
<b>5204 67</b>		RENAULT R 19
<b>5204 69</b>		RENAULT ESPACE
<b>5204 70</b>		PEUGEOT 605
<b>5204 71</b>		FIAT PUNTO
<b>5204 72</b>		DAEWOO ESPERO, LANOS, NEXIA , CIELO / OPEL ASTRA, KADETT E, VECTRA A / VAUXHALL ASTRA - BELMONT, CAVALIER
<b>5204 73</b>		RENAULT R 9, R 11
<b>5204 74</b>		FIAT BRAVA , BRAVO, MAREA, PALIO , SIENA, TIPO / LANCIA DEDRA, DELTA







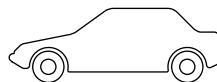

		 <b>Pour/For/Para/Für/Per/Voor</b>
<b>5204 75</b>		FORD SIERRA
<b>5204 76</b>		VOLKSWAGEN POLO
<b>5204 77</b>		AUTOBIANCHI Y10 / FIAT PANDA / LANCIA Y10
<b>5204 78</b>		RENAULT CLIO
<b>5204 79</b>		VOLKSWAGEN DERBY, POLO
<b>5204 80</b>		OPEL CORSA A / VAUXHALL NOVA
<b>5204 81</b>		RENAULT R 19
<b>5204 82</b>		FIAT UNO
<b>5204 83</b>		RENAULT R 21
<b>5204 84</b>		RENAULT R 9, R 11
<b>5204 85</b>		RENAULT R 5 / SUPER 5
<b>5204 86</b>		PEUGEOT 406
<b>5204 87</b>		OPEL CORSA B / VAUXHALL CORSA (NOVA)
<b>5204 88</b>		RENAULT LAGUNA
<b>5204 89</b>		RENAULT MEGANE

		 Pour/For/Para/Für/Per/Voor
<b>5204 90</b>		RENAULT MEGANE SCENIC
<b>5204 91</b>		RENAULT R 21
<b>5204 92</b>		FORD FIESTA I, FIESTA II
<b>5204 93</b>		SEAT IBIZA, MALAGA , CREDOS
<b>5204 94</b>		FORD MONDEO
<b>5204 95</b>		RENAULT SAFRANE
<b>5204 96</b>		VOLKSWAGEN PASSAT
<b>5204 97</b>		SEAT TOLEDO / VOLKSWAGEN GOLF II, GOLF III, JETTA, VENTO
<b>5204 98</b>		FORD FIESTA III
<b>5204 99</b>		FORD ESCORT V, ORION
<b>5204 A0</b>		RENAULT R 25
<b>5204 A1</b>		FORD FIESTA III
<b>5204 A2</b>		FORD FIESTA IV, PUMA / MAZDA 121 , REVUE
<b>5204 A3</b>		RENAULT TWINGO
<b>5204 A4</b>		FORD ESCORT V

		 <b>Pour/For/Para/Für/Per/Voor</b>
<b>5204 A5</b>		PEUGEOT 205, 306 ( ->97 ), 306 ( 97-> ) , 309
5206 AR		PEUGEOT 807
5206 E4		FIAT SCUDO / PEUGEOT EXPERT
5206 E8		FIAT ULYSSE / LANCIA ZETA / PEUGEOT 806
5206 F5		PEUGEOT 106 ( -> 96 ), 106 ( 96 -> )
5206 F8		PEUGEOT 106 ( -> 96 )
5206 G3		PEUGEOT 106 ( -> 96 ), 106 ( 96 -> )
5206 H0		PEUGEOT 106 ( 96 -> )
5206 H1		PEUGEOT PARTNER ( ->02 ), PARTNER ( 02-> )
5206 H2		PEUGEOT PARTNER ( ->02 ), PARTNER ( 02-> )
5206 H8		PEUGEOT 106 ( -> 96 ), 106 ( 96 -> )
5206 J2		PEUGEOT BOXER ( ->01 )
5206 N7		PEUGEOT PARTNER ( ->02 )
5206 P9		PEUGEOT BOXER ( ->01 )
5206 Q0		PEUGEOT BOXER ( ->01 )



Pour/For/Para/Für/Per/Voor

5206 Q1		PEUGEOT BOXER ( ->01 ), BOXER ( 01-> )
5206 Q2		PEUGEOT 106 ( -> 96 ), 106 ( 96 -> )
5206 R2		PEUGEOT EXPERT
5206 R4		FIAT ULYSSE / LANCIA ZETA / PEUGEOT 806
5206 S0		PEUGEOT 106 ( -> 96 )
5206 V1		PEUGEOT PARTNER ( ->02 ), PARTNER ( 02-> )
5206 Y7		PEUGEOT BOXER ( 01-> )
5206 Y9		PEUGEOT BOXER ( 01-> )

- 3 - TRI PAR REFERENCES**
- LISTED BY PART NUMBERS**
  - CLASIFICADO POR REFERENCIAS**
  - TRI POR REFERENCIAS**
  - GEORDNET NACH REFERENZEN**
  - ORDINE PER RIFERIMENTI**
  - OP REFERENTIE'S VOLGORDE**

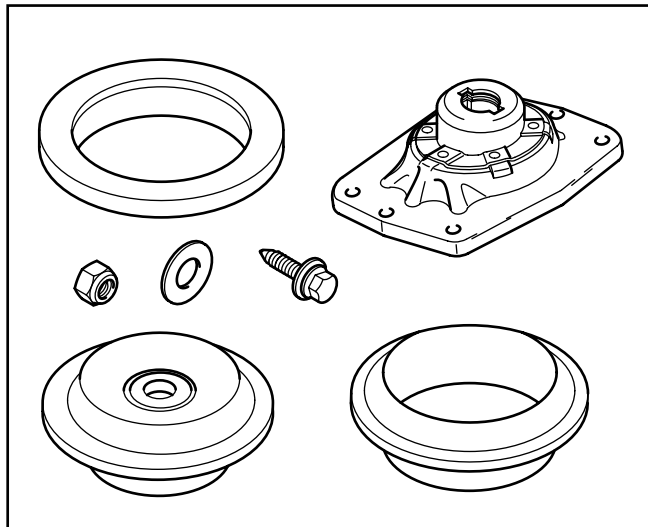

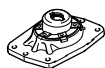

**Support d'amortisseur** - SUPPORT Of SHOCK ABSORBER - APOYO de AMORTIGUADOR - APOIO de AMORTECEDOR - STOSSDÄMPFERTRÄGER - APPOGGIO D'ASSORBITORE - STEUN VAN SCHOKBREKER











**Butée de suspension** - SUSPENSION STRUT BEARING - RODAMIENTOS DE SUPENSION ROLAMENTO DO SUPORTE DA SUSPENSÃO - FEDERBEINLAGEN - REGGISPINTE PER SOSPENSIONE - AXIAALLAGER VOOR DE OPHANGING

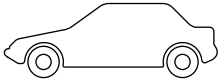









**Bloc filtrant** - FILTER BLOCK - BLOQUE FILTRADO - BLOCO FILTRADOR - FILTRIER-BLOCK - BLOCCO FILTRANTE - FILTEREREND BLOK

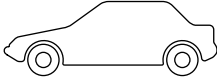







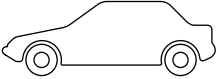

**Support à butée intégrée** - SUPPORT AND STRUT BEARING - APOYO Y TROPEZADA - APOIO E TROPEÇADO - TRÄGER UND EIGENSINNIG - APPOGGIO ED INCIAMPATA - STEUN EN GESTOTEN

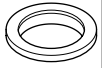
	 <b>Pour/For/Para/Für/Per/Voor</b>							
<b>5030 01</b>	FIAT PUNTO				1		2	2
<b>5030 02</b>	FIAT UNO		1	1		3		3
<b>5030 03</b>	FIAT BRAVA, BRAVO, MAREA				1		3	3
<b>5030 04</b>	FIAT BRAVA, BRAVO, TEMPRA, TIPO , LANCIA DEDRA, DELTA	1	1				3	3
<b>5030 05</b>	FIAT BRAVA, BRAVO, TEMPRA, TIPO , LANCIA DEDRA, DELTA	1	1				3	3
<b>5030 06</b>	FIAT PANDA , SEAT MARBELLA, PANDA, TERRA	1	1			2		2
<b>5030 07</b>	FORD COURRIER, ESCORT III , IV, FIESTA II, FIESTA III, ORION, P100, SIERRA		1	1				
<b>5030 08</b>	FORD ESCORT V, ORION	1	1			2		2
<b>5030 09</b>	FORD COURRIER, ESCORT III , IV, FIESTA II, FIESTA III, ORION, SIERRA		1	1				
<b>5030 10</b>	FORD COURRIER, FIESTA IV, KA , MAZDA 121 , REVUE		1	1				
<b>5030 11</b>	FORD ESCORT V	1	1			3		3
<b>5030 12</b>	FORD MONDEO		1	1				
<b>5030 13</b>	OPEL CORSA A, CORSA B, TIGRA , VAUXHALL CORSA (NOVA)	1	1			2		2
<b>5030 14</b>	OPEL COMBO, KADETT E , VAUXHALLASTRA- BELMONT					1	2	2
<b>5030 15</b>	OPEL ASTRA , VAUXHALLASTRA- BELMONT	1	1			2		2
<b>5030 16</b>	OPEL CALIBRA, VECTRA A , VAUXHALL CALIBRA, CAVALIER		1	1				
<b>5030 17</b>	PEUGEOT 306 ( ->97 ), 306 ( 97-> )	1	1			1	3	2
<b>5030 18</b>	PEUGEOT 306 ( ->97 ), 306 ( 97-> )	1	1			1	3	2
<b>5030 19</b>	PEUGEOT 405 ( ->92 )		1	1		4		1



	 <b>Pour/For/Para/Für/Per/Voor</b>							
<b>5030 20</b>	PEUGEOT 405 ( 92 -> )		1	1		3		1
<b>5030 21</b>	PEUGEOT 405 ( ->92 )		1	1		4		1
<b>5030 22</b>	PEUGEOT 205, 309		1	1		3		3
<b>5030 23</b>	PEUGEOT 406	1	1			1	3	1
<b>5030 24</b>	PEUGEOT 605		1					
<b>5030 25</b>	RENAULT R 5 , SUPER 5, EXPRESS , EXTRA , RAPID , COMBI		1	1				
<b>5030 26</b>	RENAULT CLIO I, TWINGO	1	1	1				
<b>5030 27</b>	RENAULT R 21		1	1				
<b>5030 28</b>	RENAULT LAGUNA		1	1				
<b>5030 29</b>	RENAULT R 19		1	1		1		2
<b>5030 30</b>	RENAULT CLIO I	1	1	1				
<b>5030 31</b>	RENAULT MEGANE, MEGANE SCENIC		1	1		1		2
<b>5030 32</b>	RENAULT SAFRANE		1	1				
<b>5030 33</b>	RENAULT R 21		1	1				
<b>5030 34</b>	RENAULT CLIO II, KANGOO	1	1	1		1		
<b>5030 35</b>	RENAULT R 9, R 11		1	1		1		2
<b>5030 36</b>	SEAT CORDOBA, IBIZA, TOLEDO I , VOLKSWAGEN GOLF II, GOLF III, JETTA, VENTO				1			
<b>5030 37</b>	VOLKSWAGEN DERBY, POLO				1			
<b>5030 38</b>	VOLKSWAGEN CORRADO, GOLF III, PASSAT, VENTO				1			
<b>5030 39</b>	FORD GALAXY , SEAT ALHAMBRA, CORDOBA, IBIZA, INCA, TOLEDO I , VOLKSWAGEN CADDY, CORRADO, GOLF III, PASSAT, POLO, SHARAN, VENTO		1	1				
<b>5030 40</b>	AUDI Audi 80, Audi 90, CABRIOLET, COUPE , VOLKSWAGEN PASSAT, SANTANA				1			
<b>5030 41</b>	SEAT IBIZA, MALAGA , CREDOS		1	1				

	 <b>Pour/For/Para/Für/Per/Voor</b>							
<b>5030 42</b>	AUDI A3 , TT , SEAT LEON, TOLEDO II , SKODA OCTAVIA , VOLKSWAGEN BORA, GOLF IV, NEW BEETLE		1	1				
<b>5030 43</b>	SEAT AROSA , VOLKSWAGEN LUPO, POLO		1	1				
5031 53	PEUGEOT 106 ( -> 96 ) , 106 ( 96 -> )	1	1			4		
5031 54	PEUGEOT 106 ( -> 96 )	1	1			3		
5031 66	FIAT SCUDO, ULYSSE , LANCIA ZETA , PEUGEOT 806, EXPERT	1	1			1	2	
5031 67	FIAT SCUDO, ULYSSE , LANCIA ZETA , PEUGEOT 806, EXPERT	1	1			1	2	
5031 68	FIAT SCUDO, ULYSSE, ULYSSE R , LANCIA PHEDRA, ZETA , PEUGEOT 806, 807, EXPERT	1	1			1	2	
5031 69	FIAT SCUDO, ULYSSE, ULYSSE R , LANCIA PHEDRA, ZETA , PEUGEOT 806, 807, EXPERT	1	1			1	2	
5031 70	PEUGEOT BOXER ( ->01 )	1	1			1	3	1
5031 71	PEUGEOT BOXER ( ->01 )	1	1			1	3	1
5031 72	PEUGEOT PARTNER ( ->02 )	1	1			1	3	2
5031 73	PEUGEOT PARTNER ( ->02 ), PARTNER ( 02-> )	1	1			1	3	2
5031 78	PEUGEOT BOXER ( 01-> )	1	1			1	3	1
5031 79	PEUGEOT BOXER ( 01-> )	1	1			1	3	1

**DROITS DE PROPRIETE**

"Les droits de propriété intellectuelle relatifs aux informations techniques contenues dans cette brochure appartiennent exclusivement au Constructeur. Toute reproduction et/ou diffusion de tout ou partie de ces informations sont interdites sans autorisation écrite préalable du Constructeur."

"Les informations techniques contenues dans la présente documentation sont destinées exclusivement aux professionnels de la réparation automobile. Dans certains cas, ces informations peuvent concerner la sécurité des véhicules.

Elles seront utilisées par les réparateurs automobiles auxquels elles sont destinées, sous leur entière responsabilité, à l'exclusion de celle du Constructeur."

"Les informations techniques figurant dans cette brochure peuvent faire l'objet de mises à jour en fonction de l'évolution des caractéristiques des modèles de chaque gamme.

Nous invitons les réparateurs automobiles à se mettre en rapport périodiquement avec le Constructeur/avec son réseau, pour se procurer les mises à jour nécessaires."

F

**PROPERTY RIGHTS**

"The intellectual copyrights relating to the technical information contained in this brochure are the exclusive property of the Manufacturer. Any reproduction and/or distribution of all or part of this information is forbidden without the Manufacturer's preliminary written authorisation."

"The technical information contained in this documentation is intended exclusively for automobile repair professionals. In certain cases, the information may relate to vehicle safety.

It will be used by the automobile repairers to whom it is addressed, on their full responsibility, to the exclusion of the Manufacturer's liability."

"The technical information that figures in this brochure may be updated in accordance with the changing features of models in each range.

We would request automobile repairers to get in touch with the Manufacturer/the network at regular intervals, to obtain the necessary updates."

GB

**DERECHOS DE PROPIEDAD**

"Los derechos de propiedad intelectual relativos a las informaciones técnicas que figuran en este folleto pertenecen exclusivamente al Constructor. Se prohíbe toda reproducción y/o difusión de la totalidad o parte de estas informaciones sin autorización previa y por escrito del Constructor."

"Las informaciones técnicas que figuran en la presente documentación están destinadas exclusivamente a los profesionales de la reparación de automóviles. En ciertos casos, pueden afectar a la seguridad de los vehículos.

Serán utilizadas por los reparadores de automóviles, a quienes están destinadas, bajo su entera responsabilidad, excluyéndose la del Constructor."

"Las informaciones técnicas que figuran en este folleto pueden ser objeto de actualizaciones en función de la evolución de las características de los modelos de cada gama.

Invitamos a los reparadores de automóviles a ponerse en contacto periódicamente con el Constructor/con su red, para conseguir las actualizaciones necesarias."

E

**DIREITOS DE PROPRIEDADE**

"Os direitos de propriedade intelectual relativos às informações técnicas contidas nesta brochura pertencem exclusivamente ao Construtor. Qualquer reprodução e/ou difusão da totalidade ou parte destas informações são proibidas sem a autorização prévia e escrita do Construtor."

"As informações técnicas contidas na presente documentação destinam-se exclusivamente aos profissionais da reparação automóvel. Em certos casos, estas informações podem referir-se à segurança dos veículos.

Serão utilizadas pelos reparadores automóvel a que se destinam, sob a sua total responsabilidade, excluindo a responsabilidade do Construtor."

"As informações técnicas que figuram nesta brochura podem ser objecto de actualizações consoante a evolução das características dos modelos de cada gama.

Os reparadores automóvel são convidados a entrarem periodicamente em contacto com o Construtor/com a sua rede, para obterem as actualizações necessárias."

P

**EIGENTUMSRECHTE**

"Die Rechte auf geistiges Eigentum in Verbindung mit den in der vorliegenden Broschüre enthaltenen technischen Informationen stehen ausschließlich dem Hersteller zu. Jede vollständige oder teilweise Reproduktion und/oder Verbreitung dieser Informationen sind ohne vorherige schriftliche Genehmigung des Herstellers verboten."

"Die in der vorliegenden Dokumentation enthaltenen technischen Informationen sind ausschließlich für Autoreparaturfachleute bestimmt. In einigen Fällen können diese Informationen die Sicherheit der Fahrzeuge betreffen.

Sie werden von den Kraftfahrzeughandwerkern, für die sie bestimmt sind, in ihrer eigenen Verantwortung benutzt, unter Ausschluß der Verantwortung des Herstellers."

"Die in dieser Broschüre enthaltenen technischen Informationen können je nach Fortentwicklung der verschiedenen Modelle in jeder Produktreihe aktualisiert werden.

Wir fordern die Kraftfahrzeughandwerker auf, sich regelmäßig an den Hersteller/an sein Vertriebsnetz zu wenden, um sich die erforderlichen Aktualisierungen zu beschaffen".

D

**DIRITTI DI PROPRIETÀ**

"I diritti di proprietà intellettuale riguardanti le informazioni tecniche contenute nel presente manuale appartengono esclusivamente al Costruttore. Qualsiasi riproduzione e/o diffusione di tutto o parte di queste informazioni sono vietate senza autorizzazione preventiva scritta del Costruttore."

"Le informazioni tecniche contenute nella presente documentazione sono destinate esclusivamente agli autoriparatori. In alcuni casi, queste informazioni possono riguardare la sicurezza dei veicoli.

Esse verranno utilizzate dagli autoriparatori ai quali esse sono destinate sotto la loro piena responsabilità, ad esclusione di quella del Costruttore."

"Le informazioni tecniche contenute nel presente manuale possono essere soggetto ad aggiornamenti in funzione dell'evoluzione delle caratteristiche dei modelli di ogni gamma.

Invitiamo gli autoriparatori a mettersi in contatto periodicamente con il Costruttore/la sua rete, per procurarsi gli aggiornamenti necessari."

I

**EIGENDOMSRECHT**

"Het individuele eigendomsrecht betreffende technische informatie die in deze brochure staat vermeld behoort exclusief aan de Fabrikant. Alle reproductie en/of verspreiding van alles of een gedeelte van deze informatie is verboden zonder voorafgaande, schriftelijke toestemming van de Fabrikant."

"De technische informatie die in deze documentatie staat vermeld is alleen bestemd voor vakmensen in de branche van de automobielreparatie. In bepaalde gevallen kan deze informatie betrekking hebben op de veiligheid van de wagens.

Deze wordt gebruikt door automobielreparateurs waarvoor zij is bestemd, onder hun volledig verantwoordelijkheid, waardoor die van de Fabrikant vervalt."

"De technische informatie die in deze brochure staat vermeld kan onderhavig zijn aan aanvullingen als gevolg van een ontwikkeling in de technische gegevens van de modellen van elke serie.

Wij vragen de automobielreparateurs zich regelmatig met de Fabrikant of zijn netwerk in verbinding te stellen, om deze noodzakelijke aanvullingen te verkrijgen."

NL