

ALTERNATEURS & DEMARREURS ECHANGE STANDARD  
FACTORY EXCHANGE ALTERNATOR & STARTER MOTOR  
CAMBIO ESTANDAR ALTERNADOR & MOTOR DE ARRANQUE  
ALTERNADOR & MOTOR DE ARRANQUE RENOVADOS  
WERKS AUSTAUSCH GENERATOR & ANLASSER  
SOSTITUZIONE STANDARD ALTERNATORI & MOTORINI  
AVVIAMENTO  
FABRIEKSRUIL DYNAMO & START MOTOR

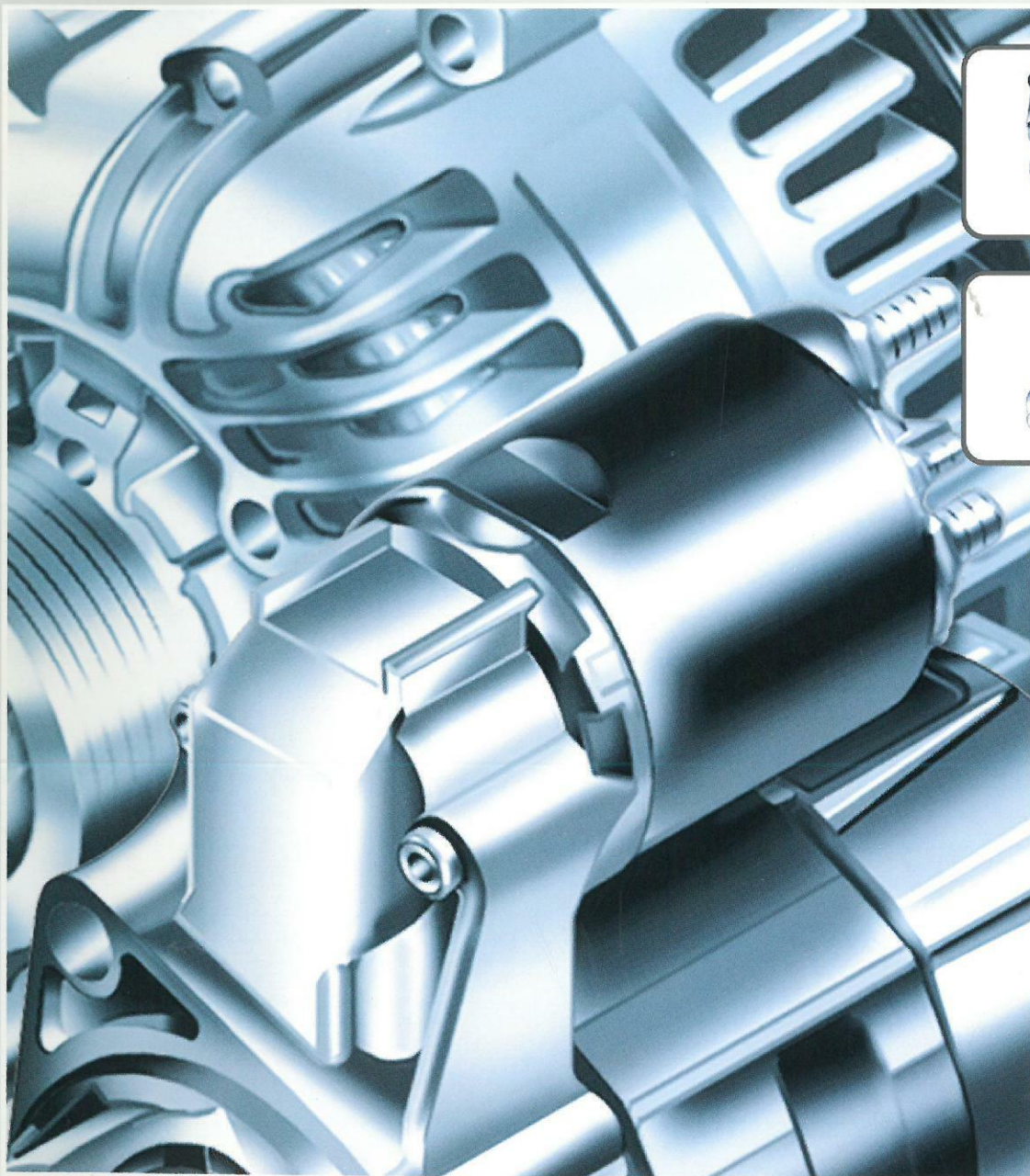

CAT. 14.747



**CITROËN**

05/2003





5

CITROËN AX	6
CITROËN SAXO	7
CITROËN C3	10
CITROËN ZX	11
CITROËN XSARA → 27/08/2000	15
CITROËN XSARA 28/08/2000 →	19
CITROËN XSARA PICASSO	21
CITROËN BX	23
CITROËN XANTIA	26
CITROËN C5	29
CITROËN XM → 95	30
CITROËN XM 95 →	32
CITROËN EVASION	36
CITROËN C8	39
CITROËN C15	40
CITROËN BERLINGO (I)	42
CITROËN BERLINGO (II) 28/11/2002 →	46
CITROËN JUMPY	47
CITROËN JUMPER → 02/2002	49
CITROËN JUMPER 02/2002 →	51
CITROËN C25	52
2 CV - LN - LNA - VISA	53
GS - GSA - AXEL	54
CX	55
C35	56

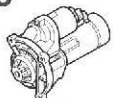

57

CITROËN AX	58
CITROËN SAXO	60
CITROËN C3	61
CITROËN ZX	62
CITROËN XSARA	64
CITROËN XSARA PICASSO	66
CITROËN BX	67
CITROËN XANTIA	69
CITROËN C5	71
CITROËN XM	72
CITROËN EVASION	74
CITROËN C8	75
CITROËN C15	76
CITROËN BERLINGO	78
CITROËN JUMPY	80
CITROËN JUMPER	81
CITROËN C25	83
2 CV - LN - LNA - VISA	85
GS - GSA - AXEL - AMI	87
CX	88
C35	89





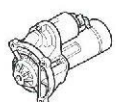

91



97



**FICHE QUALITE DES EDITIONS CATALOGUE PIECES AUTO  
AMENDMENT REQUEST QUALITY FORM PARTS CATALOGUE  
FICHA CALIDAD DE LAS EDICIONES CATALOGOS PIEZAS AUTO  
FICHA QUALIDADE EDIÇÕES CATÁLOGOS PEÇAS AUTO  
QUALITÄTS-DATENBLATT KATALOGAUSGABEN KFZ-TEILE  
SCHEDA QUALITÀ DELLE EDIZIONI CATALOGHI PEZZI AUTO  
KWALITEITSFICHE ONDERDELENCATALOGUS**

EXPEDITEUR / SENDER	DESTINATAIRE / RECIPIENT
SOCIETE / COMPANY :	CITROËN / DSPC / MKSP
NOM / NAME :	NOM / NAME : Didier PAPILLAUD
 _____	 01.58.79.73.95
 _____	 <a href="mailto:didier.papillaud@mpsa.com">didier.papillaud@mpsa.com</a>
 _____	

N° CAT 14. . . . .

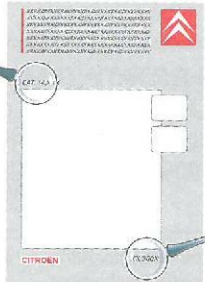

. . . / 200 .

**ANOMALIE / CORRECTION / ANOMALIA / ANOMALIA / ANOMALIEN / ANOMALIA / FOUNT**



**SUGGESTION / SUGGESTION / SUGERENCIA / SUGESTÃO / VORSCHLÄGE / SUGGERIMENTO / SUGGESTIE**





## CATALOGUE MACHINES TOURNANTES CITROËN

**F**

Soucieux de prendre soin de l'environnement, conscient de vos impératifs rentabilité, service client, qualité, gain de temps, CITROËN vous propose une gamme complète d'alternateurs et de démarreurs rénovés **SANS AMIANTE**

Un processus industriel de rénovation satisfaisant aux exigences de la pièce d'origine, vous assure de toujours satisfaire vos clients.



- Pièces d'usure systématiquement remplacées par des composants répondant aux spécifications d'origine.
- Contrôles à toutes les étapes de la rénovation.

- Tests systématiques en conditions d'utilisation sur toutes les machines.
- Conditionnement spécifiques évitant toute détérioration.
- Garantie 12 mois sur l'ensemble du réseau par remplacement complet de la machine.

Afin d'assurer un service parfait, dans les meilleures conditions, les organes usagés retournés en contrepartie ne devront pas avoir subi de détérioration extérieurement visible - autre que l'usure normale - et devront être normalement assemblés.

Tout organe usagé doit être retourné dès dépose selon les modalités prescrites par le Département Pièces de Rechange.

La garantie de 12 mois est applicable pièces et main d'oeuvre sur l'ensemble du réseau CITROËN. Elle est assurée par échange de l'organe complet.

Lorsqu'il s'agit d'un véhicule sous garantie constructeur, le changement de pièces doit impérativement être effectuée par une pièce neuve.

Tous les renseignements techniques complémentaires sont disponibles sur les microcatalogues.



## CITROËN ROTATING MACHINES CATALOGUE

**GB**

Aiming at care of the environment and being aware of your requirements as to economy of operation, customer service, quality and timesaving, CITROËN offers you a complete range of alternators and starter motors reconditioned **ASBESTOS FREE**

An industrial reconditioning process which meets the requirements of the original item ensures that you will always be able to satisfy your customers.



- Worn items systematically replaced by components meeting the original specification.
- Checks at all stages of reconditioning.

- Systematic tests in use conditions on all machines.
- Specialised wrappings prevent any deterioration.
- 12 months guarantee throughout the network by complete replacement of machine.

In order to guarantee a high-quality service, in the best conditions, used units returned for exchange must not display any externally visible signs of damage - apart from normal wear - and must be assembled in the normal way.

Each used unit must be returned when handed in in accordance with the procedure specified by the Spare Parts Department.

The 12 months guarantee applies to material and labour, throughout the CITROËN network. The guarantee is given for exchange of the complete unit.

If the vehicle is covered by manufacturer's warranty, it is essential that items are exchanged for new parts.

All the additional technical information will be found in the microcatalogues.



## CATALOGO DE MAQUINAS GIRATORIAS CITROËN

**E**

Deseoso de preservar el medio ambiente, consciente de los imperativos de rentabilidad que usted tiene -servicio a la clientela, calidad, ganar tiempo-, CITROËN le propone una gama completa de alternadores y de arrancadores renovados **SENZA AMIANTO**

Un proceso industrial de renovación conforme a las exigencias de la pieza de origen, le da la seguridad de satisfacer siempre a sus clientes.



- Piezas de desgaste sistemáticamente reemplazadas por componentes que responden a las especificaciones de fábrica.
- Controles en todas las etapas que evitan el deterioro.

- Pruebas sistemáticas en condiciones de utilización en todas las máquinas.
- Acondicionamientos específicos que evitan el deterioro.
- Garantía de 12 meses para el conjunto de la red mediante reemplazo completo de la máquina.

Con la finalidad de garantizar un servicio perfecto, con las mejores condiciones, los órganos desgastados devueltos en contrapartida, no deberán haber sufrido ningún deterioro visible exteriormente, solamente el normal, y deberán estar ensamblados normalmente.

Todo órgano desgastado debe ser devuelto en cuanto se lo desmonte, conforme a las modalidades que recomiendo el Departamento de Piezas de Recambio.

La garantía de 12 meses es aplicable a las piezas y mano de obra en toda la red CITROËN. Se realiza mediante el intercambio del órgano completo. Cuando se trata de un vehículo con garantía del constructor, la pieza debe ser cambiada por una nueva.

Todas las informaciones técnicas complementarias se encuentran disponibles en los microcatálogos.





## CATÁLOGO MÁQUINAS ROTATIVAS CITROËN

Preocupada com o meio ambiente, consciente da rentabilidade, serviço cliente, qualidade, economia de tempo, CITROËN propõe uma gama completa de alternadores e motores de arranque renovados.

**SEM AMIANTO**

P

Um processo industrial de renovação que satisfaz as exigências da peça de origem, com a segurança de satisfação dos clientes.



- Peças de uso sistematicamente substituídas por componentes conforme especificações de origem.
- Controlo em todas as etapas da renovação.

- Testes sistemáticos em condições de utilização em todas as máquinas.
- Acondicionamento específico evitando qualquer deterioração.
- Garantia 12 meses para toda a rede pela substituição completa da máquina.

A fim de assegurar um serviço perfeito, nas melhores condições, os órgãos usados devolvidos em contrapartida não devem estar deteriorados exteriormente - além do uso normal - e devem estar montados normalmente.

Qualquer órgão usado deve ser devolvido logo após desmontagem conforme as normas prescritas pelo Departamento de peças Soltas.

A garantia de 12 meses é aplicada às peças e mão de obra em toda a rede CITROËN. É assegurada pela troca do órgão completo.

Quando se trata dum veículo com garantia, a substituição da peça será imperativamente efectuada por uma peça nova.

Todas as informações técnicas complementares estão disponíveis nas microfichas.



## KATALOG FÜR DREHENDE MASCHINEN CITROËN

Auf Umweltschutz bedacht und der Imperative der Rentabilität, des Kunden - Services, der Qualität und des Zeitgewinns bewußt, bietet Ihnen CITROËN eine vollständige Reihe neu aufgearbeiteter Wechselstromerzeuger und Starter an

**ASBESTFREI**

D

Ein industrielles Erneuerungsverfahren, das den Ansprüchen des ursprünglichen Teiles genügt, gewährleistet Ihnen die ständige Zufriedenstellung Ihrer Kundschaft.



- Verschleißteile werden systematisch durch den ursprünglichen Anforderungen genügende Komponenten ersetzt.
- Kontrollen an allen Stufen des Erneuerungsverfahrens.

- Systematische Tests unter Gebrauchsbedingungen an allen Maschinen.
- Besondere, allen Schädigungen vorbeugende, Verpackungen.
- Garantie 12 Monate auf dem gesamten Netz durch völligen Ersatz der Maschine.

Um einen perfekten Service unter besten Bedingungen zu gewährleisten dürfen die auf dem Umtauschwege zurückgenommenen debrauchten Organe keine äußerlich sichtbaren Schäden erlitten haben - außer Normalverschleiß - und müssen auch normal zusammengebaut sein.

Alle gebrauchten Organe müssen gemäß den von der Abteilung Ersatzteile vorgeschriebenen Verfahren sofort nach dem Ausbau zurückgesandt werden.

Die Garantie von 12 Monaten gilt für Teile und Arbeitslohn für das gesamte CITROËN - Netz. Sie wird erfüllt durch vollständigen Teileaustausch. Wenn es sich um ein Fahrzeug unter Herstellergarantie handelt muß das gebrauchte Teil unbedingt durch ein Neuteil ersetzt werden.

Alle zusätzlichen technischen Auskünfte sind in den Mikrokatalogen verfügbar.



## CATALOGO MICCHINE ELETTRICHE CITROËN

Con la costante preoccupazione della cura dell'ambiente, consci dei vostri imperativi di redditività, servizio clientela, qualità, risparmio di tempo, CITROËN vi propone una gamma completa di alternatori e di motorini di avviamento rinnovati

**SIN AMIANTO**

I

Un processo industriale di rinnovazione soddisfacente per le esigenze del pezzo d'origine, vi assicura sempre la soddisfazione dei vostri clienti.



- Pezzi di usura sistematicamente sostituiti con componenti conformi alle specifiche d'origine.
- Controlli a tutte le tappe del rinnovo.

- Test sistemati in condizioni di utilizzazione su tutte le macchine.
- Imballaggi specifici che evitano eventuali deteriorazioni.
- Garanzia 12 mesi sull'insieme della rete con sostituzione completa della macchina.

Per garantire un servizio perfetto, nelle migliori condizioni possibili, gli organi usati rispediti in sostituzione non dovranno aver subito deteriorazioni visibili esteriormente - oltre all'usura normale - e dovranno essere assiemate normalmente.

Qualsiasi organo usato deve essere rispedito subito dopo lo smontaggio conformemente all'modalità prescritte dal Dipartimento Pezzi di Ricambio.

La garanzia di 12 mesi è applicabile a pezzi e mano d'opera sull'insieme della rete CITROËN. Viene realizzata con sostituzione dell'organo completo. Se si tratta di un veicolo in garanzia costruttore, la sostituzione dei pezzi deve imperativamente essere effettuata con un pezzo nuovo.

Tutte le informazioni tecniche complementari sono disponibili sui Microcataloghi.



## CITROËN DRAAIENDE MACHINE CATALOGUS

NL

Op de milieuzorg bedacht, van Uw rentabiliteit, cliëntenafdeling, kwaliteit, tijdwinst bewust, stelt CITROËN U een complete reeks van vernieuwde starters en wisselstroomdynamo's voor  
**ASBESTVRIJ**

Met een aan de eisen van het oorspronkelijk onderdeel beantwoordend industrieel renovatieproces, bent U verzekerd uw cliënten steeds tevreden te stellen.



- Systematische vervanging van slijtage delen door componenten die aan de oorspronkelijke specificaties beantwoorden.
- Controles bij alle renovatie fasen.

- Systematische proeven in gebruikstoestand op alle machines.
- Specifieke conditioneringen die alle beschadigingen vermijden.
- 12 maanden garantie op het gehele net door complete vervanging van de machine.

Ten einde in de beste voorwaarden een perfecte dienst te verzekeren, dienen de in ruil geretourneerde versleten delen geen zichtbare uitwendige schade te hebben ondergaan - anders dan de normale slijtage - en moeten normaal gemonteerd worden.

Zodra demontage, moet elk versleten onderdeel volgens de door het Departement van de Vervangingsdelen voorgeschreven modaliteiten geretourneerd worden.

De garantie van 12 maand is op geheel het CITROËN net voor onderdelen en arbeidskrachten van toepassing. Zij verzekert de complete vernieuwing van het onderdeel. Wanneer het een voertuig onder autoconstructeursgarantie betreft, moet de vervanging van de onderdelen imperatief door een nieuw onderdeel uitgevoerd worden.

Alle aanvullende technische inlichtingen staan in de Microcatalogus vermeld.



**ALTERNATEURS  
ALTERNATORS  
ALTERNADORES  
ALTERNADOR  
LICHTMASCHINEN  
ALTERNATORI  
WISSELSTROOMDYNAMO'S**

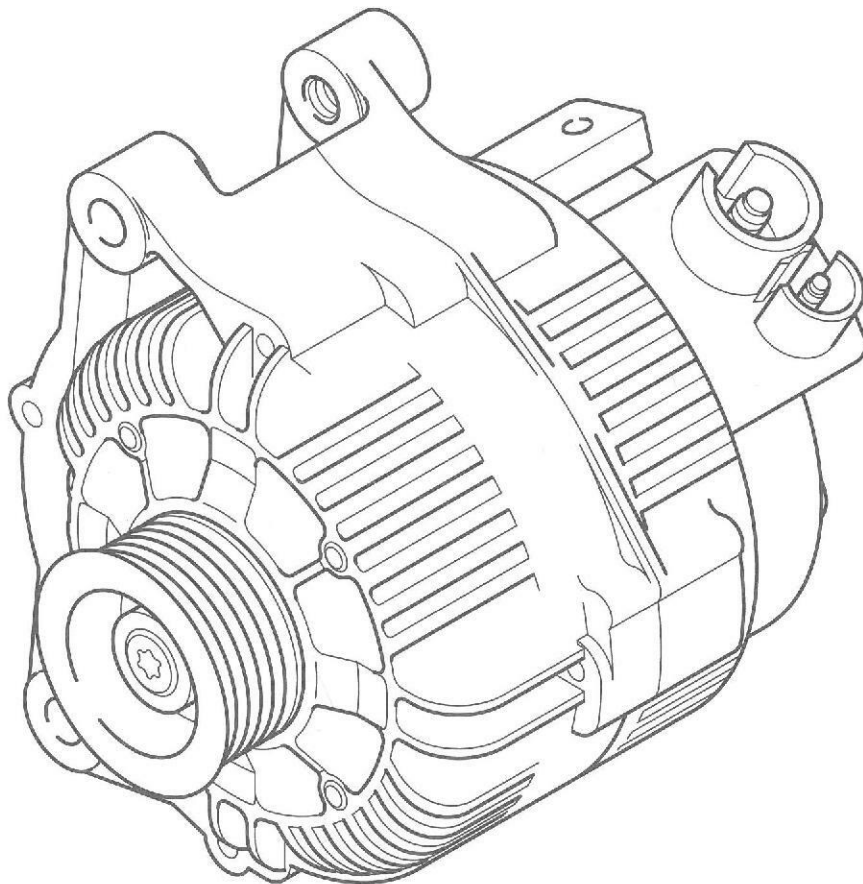

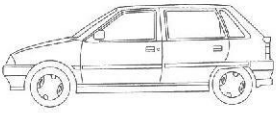
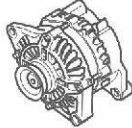
<b>CITROËN AX</b>						
	Fournisseur Supplier Proveedor Fornecedor Lieferant Fornitore Leverancier	Repère Identification mark Marca Referencia Bauteilmarkierung Riferimento Merkteken	Classe Class Clase Classe Classe Classe	Ampère Ampere Amperios Ampère Ampere Ampere		
					Neuf	E.S.
<b>Essence - Petrol - Gazolina - Gasolina- Benzin - Benzina - Benzine</b>						
(TU9-TU1-TU3) 1 L - 1,1 L - 1,4 L Sauf Réfri	Valeo " " Bosch " "	A13N 129 A13N 175 A13N 215 0 120 489 467 0 120 489 476 9 120 144 243 A 001T 02674	5	50A	5705 89	5705 Z3
	Valeo " Paris-Rhône	A13N 176 A13N 216 A13N 130	7	70A	5705 90	95 668 060
(TU9-TU1-TU3) 1 L - 1,1 L - 1,4 L Réfri Pour Peugeot 205- 309-405	Valeo " " " " "	A14N 123 A14N 145 A14N 173 A14N 181 A14N 194 A14N 195	8	80A	5705 K4	5705 Z6
<b>Diesel - Gasoleo</b>						
(TUD3) 1,4 L	Valeo " " Bosch " "	A13N 129 A13N 175 A13N 215 0 120 489 467 0 120 489 476 9 120 144 243	5	50A	5705 89	5705 Z3
	Valeo " "	A11VI 38 A11VI 44 A11VI 56	7	70A	5705 J9	5705 M7
(TUD5) 1,5 L	Valeo	A11VI 45	7	70A	5705 L1	5705 N1
	Valeo	A13VI 84	8	80A	5705 L2	5705 N3
<p>POUR : FOR - PARA - PARA - FÜR - PER - VOOR  NEUF : NEW - NUEVO - NOVO - NEU - NUOVO - NIEUW  E.S. ECHANGE STANDARD : STANDARD EXCHANGE - CAMBIO ESTANDARD - R. RENOVADO - AUSTAUSCH - REVISIONATO - FABRIEKSRUIL  SAUF REFRI : EXCEPT AIR CONDITIONING - SALVO AIRE ACONDICIONARD - SEM CLIMATIZAÇÃO - AUSSER EINFACHE KLIMA - SALVO REFRIGERAZIONE - BEHALVE AIRCO  REFRI : AIR CONDITIONING - AIRE ACONDICIONARD - SEM CLIMATIZAÇÃO - EINFACHE KLIMA - REFRIGERAZIONE - AIRCO</p>						



# CITROËN SAXO

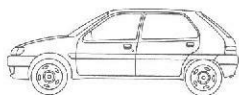

Fournisseur  
Supplier  
Proveedor  
Fornecedor  
Lieferant  
Fornitore  
Leverancier

Repère  
Identification mark  
Marca  
Referencia  
Bauteilmarkierung  
Riferimento  
Merkteken

Classe  
Class  
Clase  
Classe  
Klasse  
Klasse

Ampère  
Ampere  
Amperios  
Ampère  
Ampere  
Ampere

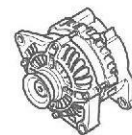

Neuf

E.S.

## Essence - Petrol - Gazolina - Gasolina - Benzin - Benzina - Benzine

(TU9M -TU1M+-TU3JP) 1L - 1,1L - 1,4L Sauf Réfri (Sans cic) <b>Pour Peugeot 106</b>	Valeo " " Bosch Magnet Marelli "	A11VI 11 A11VI 43 A11VI 55 0 120 335 007 63 321 641 63 321 770	7	70A	5705 E1	5705 X9
(TU9M -TU1M+-TU3JP) 1L - 1,1L - 1,4L Sauf Réfri (Avec cic) <b>Pour Peugeot 106</b>	Valeo	A11VI 101	7	70A	5705 4G	5705 5L
(TU1M+-TU3JP-TU5JP) 1,1L - 1,4L - 1,6L (TU5J4) 1,6L 16S Sauf Réfri (Sans cic) <b>Pour Peugeot 106</b>	Valeo Magnet Marelli " " " Magnet Marelli "	A11VI 89 63 321 671 63 321 771 A13VI 46 A13VI 96 A13VI 83 A13VI 240 63 321 723 63 321 772	7	70A	5705 1J	5705 1Y
(TU1M+ -TU3JP-TU5JP) 1,1L - 1,4L - 1,6L (Avec cic) <b>Pour Peugeot 106</b>	Valeo " " " Magnet Marelli "	A11VI 102 A13VI 245 A13VI 256	7	70A	5705 4N RP 5705 5Z	5705 5N
(TU1M+-TU3JP-TU5JP TU5J4) 1,1L - 1,4L - 1,6L - 1,6L 16S Réfri (Avec cic) <b>Pour Peugeot 106</b>	Valeo	A13VI 141	8	80A	5705 4P	5705 5Q
(TU1M+-TU3JP-TU5JP TU5J4) 1,1L - 1,4L - 1,6L - 1,6L 16S Réfri (Avec cic) <b>Pour Peugeot 106</b>	Valeo	A13VI 141	9	90A	5705 X2	5705 1L

POUR : FOR - PARA - PARA - FÜR - PER - VOOR

SANS CIC - SANS CONNECTION INFO CHARGE : WITHOUT LOAD INFORMATION CONNECTION - SIN CONEXION INFO CARGA - SEM CONECCÃO INFO CARGA - OHNE ANSCHLUSS LADEZUSTANDSANZEIGE - SENZA CONNESSIONE INFO CARICO - ZONDER AANSLUITING OPLAADINFO

AVEC CIC - AVEC CONNECTION INFO CHARGE : WITH LOAD INFORMATION CONNECTION - CON CONEXION INFO CARGA - COM CONECCÃO INFO CARGA - MIT ANSCHLUSS LADEZUSTANDSANZEIGE - CON CONNESSIONE INFO CARICO - MET AANSLUITING OPLAADINFO

NEUF : NEW - NUEVO - NOVO - NEU - NUOVO - NIEUW

E.S. EXCHANGE STANDARD : STANDARD EXCHANGE - CAMBIO ESTANDARD - R.RENOVADO - AUSTAUSCH - REVISIONATO - FABRIEKSRUIL

SAUF REFRI : EXCEPT AIR CONDITIONING - SALVO AIRE ACONDICIONARD - SEM CLIMATIZAÇÃO - AUSSER EINFACHE KLIMA - SALVO REFRIGERAZIONE - BEHALVE AIRCO

REFRI : AIR CONDITIONING - AIRE ACONDICIONARD - SEM CLIMATIZAÇÃO - EINFACHE KLIMA - REFRIGERAZIONE - AIRCO

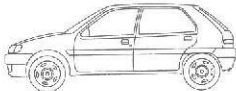
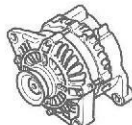
<b>CITROËN SAXO</b>								
	Fournisseur Supplier Provedor Fornecedor Lieferant Fornitore Leverancier	Repère Identification mark Marca Referencia Bauteilmarkierung Riferimento Merkteken	Classe Class Clase Classe Klasse Klasse	Ampère Ampere Amperios Ampère Ampere Ampere				
					Neuf	E.S.		
<b>Essence - Petrol - Gazolina - Gazolina - Benzin - Benzina - Benzine</b>								
(TU1M+ - TU3JP TU5JP) <b>1,1L - 1,4L - 1,6L</b> (Avec cic +cp)  <i>Pour Peugeot 106</i>	Valeo Magneti Marelli	A11VI 108 63 321 741	7	70A	<i>5705 5X</i> <b>RP 5705 5Z</b>	<b>5705 6T</b>		
	Valeo Denso	A13VI 278 63 321 740	8	80A	<i>5705 5Y</i> <b>RP 5705 6M</b>	<b>5705 6V</b>		
(TU1M+ - TU3JP-TU5JP) <b>1,1L - 1,4L - 1,6L</b> (Avec cic +cp)  <i>Pour Peugeot 106</i>	Valeo	A13VI 288	8	80A	<b>5705 6M</b>	<b>5705 7H</b>		
(TU1M+ - TU3JP-TU5JP) <b>1,1L - 1,4L - 1,6L</b> Réfri (Avec cic +cp)  <i>Pour Peugeot 106</i>	Valeo	A13VI 279	9	90A	<b>5705 5Z</b>	<b>5705 6X</b>		
(TU1M+ - TU3JP-TU5JP) <b>1,1L - 1,4L - 1,6L</b> Réfri (Avec cic)  <i>Pour Peugeot 106</i>	Valeo	A13VI 246	9	90A	<b>5705 4Q</b>	<b>5705 5S</b>		
(TU5J4) <b>1,6L 16S</b>  (Sans cic)  <i>Pour Peugeot 106</i>	Valeo " " " Magneti Marelli "	A13VI 46 A13VI 96 A13VI 83 A13VI 240 63 321 723 63 321 772	8	80A	<i>5705 E2</i> <b>RP 5705 X2</b> (90A)	<b>5705 YO</b>		
(TU5J4) <b>1,6L 16S</b> Σαυφ Réfri  (Avec cic)  <i>Pour Peugeot 106</i>	Valeo "	A13VI 245 A13VI 256	8	80A	<b>5705 4P</b>	<b>5705 5Q</b>		
<p>POUR : FOR - PARA - PARA - FÜR - PER - VOOR  SANS CIC - SANS CONNECTION INFO CHARGE : WITHOUT LOAD INFORMATION CONNECTION - SIN CONEXION INFO CARGA - SEM CONEÇÃO INFO CARGA - OHNE ANSCHLUSS LADEZUSTANDSANZEIGE - SENZA CONNESSIONE INFO CARICO - ZONDER AANSLUITING OPLAADINFO  AVEC CIC+CP - AVEC CONNECTION INFO CHARGE + CHARGE PROGRESSIVE: WITH LOAD INFORMATION CONNECTION + VARIABLE OUTPUT - CON CONEXION INFO CARGA + CARGA PROGRESIVA - COM CONEÇÃO INFO CARGA + CARGA PROGRESSIVA - MIT ANSCHLUSS LADEZUSTANDSANZEIGE + PROGRESSIVE LASTANPASSUNG  CON CONNESSIONE INFO CARICO + CARICO PROGRESSIVO - MET AANSLUITING OPLAADINFO + PROGRESSIEVE LADING  AVEC CIC - AVEC CONNECTION INFO CHARGE : WITH LOAD INFORMATION CONNECTION - CON CONEXION INFO CARGA - COM CONEÇÃO INFO CARGA - MIT ANSCHLUSS LADEZUSTANDSANZEIGE - CON CONNESSIONE INFO CARICO - MET AANSLUITING OPLAADINFO  NEUF : NEW - NUEVO - NOVO - NEU - NUOVO - NIEUW  E.S. ECHANGE STANDARD : STANDARD EXCHANGE - CAMBIO ESTANDARD - R.RENOVADO - AUSTAUSCH - REVISIONATO - FABRIEKSRUIJ  SAUF REFRI : EXCEPT AIR CONDITIONING - SALVO AIRE ACONDICIONARD - SEM CLIMATIZAÇÃO - AUSSER EINFACHE KLIMA - SALVO REFRIGERAZIONE - BEHALVE AIRCO  REFRI : AIR CONDITIONING - AIRE ACONDICIONARD - SEM CLIMATIZAÇÃO - EINFACHE KLIMA - REFRIGERAZIONE - AIRCO</p>								



# CITROËN SAXO



Fournisseur  
Supplier  
Proveedor  
Fornecedor  
Lieferant  
Fornitore  
Leverancier

Repère  
Identification mark  
Marca  
Referencia  
Bauteilmarkierung  
Riferimento  
Merkteken

Classe  
Class  
Clase  
Classe  
Klasse  
Klasse  
Klasse

Ampère  
Ampere  
Amperios  
Ampère  
Ampere  
Ampere  
Ampere

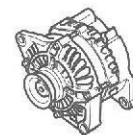

Neuf

E.S.

## Essence - Petrol - Gazolina - Gazolina - Benzin - Benzina - Benzine

(TU5J4)  
**1,6L 16S Sauf Réfri**  
  
(Avec cic+cp)  
  
*Pour Peugeot 106*

Valeo

A13VI 288

8

80A

**5705 6M****5705 7H**

(TU5J4)  
**1,6L 16S Réfri**  
  
(Avec cic)

Valeo

A13VI 246

9

90A

**5705 4Q****5705 5S**

*Pour Peugeot 106*

## Diesel - Gasoleo

(TUD5 - TUD5B)  
**1,5L**  
  
*Pour Peugeot 106*

Valeo

A11VI 45

7

70A

**5705 L1****5705 N1**

Valeo

A13VI 84

8

80A

**5705 L2****5705 N3**

Valeo

A13VI 142  
A13VI 273

9

90A

**5705 X3****5705 1N**

POUR : FOR - PARA - PARA - FÜR - PER - VOOR

AVEC CIC - AVEC CONNECTION INFO CHARGE : WITH LOAD INFORMATION CONNECTION - CON CONEXION INFO CARGA - COM CONEÇÃO INFO CARGA - MIT ANSCHLUSS LADEZUSTANDSANZEIGE - CON CONNESSIONE INFO CARICO - MET AANSLUITING OPLAADINFO

AVEC CIC+CP - AVEC CONNECTION INFO CHARGE + CHARGE PROGRESSIVE : WITH LOAD INFORMATION CONNECTION + VARIABLE OUTPUT - CON CONEXION INFO CARGA + CARGA PROGRESIVA - COM CONEÇÃO INFO CARGA + CARGA PROGRESSIVA - MIT ANSCHLUSS LADEZUSTANDSANZEIGE + PROGRESSIVE LASTANPASSUNG CON CONNESSIONE INFO CARICO + CARICO PROGRESSIVO - MET AANSLUITING OPLAADINFO + PROGRESSIEVE LADING

NEUF : NEW - NUEVO - NOVO - NEU - NUOVO - NIEUW

E.S. ECHANGE STANDARD : STANDARD EXCHANGE - CAMBIO ESTANDARD - R.RENOVADO - AUSTAUSCH - REVISIONATO - FABRIEKSRUIL

SAUF REFRI : EXCEPT AIR CONDITIONING - SALVO AIRE ACONDICIONARD - SEM CLIMATIZAÇÃO - AUSSER EINFACHE KLIMA - SALVO REFRIGERAZIONE - BEHALVE AIRCO

REFRI : AIR CONDITIONING - AIRE ACONDICIONARD - SEM CLIMATIZAÇÃO - EINFACHE KLIMA - REFRIGERAZIONE - AIRCO

# CITROËN C3

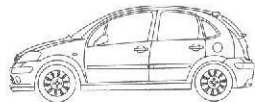

Fournisseur  
Supplier  
Proveedor  
Fornecedor  
Lieferant  
Fornitore  
Leverancier

Repère  
Identification mark  
Marca  
Referencia  
Bauteilmarkierung  
Riferimento  
Merkteken

Classe  
Class  
Clase  
Classe  
Classe  
Classe  
Klasse

Ampère  
Ampere  
Amperios  
Ampère  
Ampere  
Ampere  
Ampere

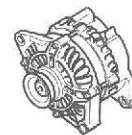

Neuf

E.S.

## Essence - Petrol - Gazolina - Gasolina - Benzin - Benzina - Benzine

(TU1JP-TU3JP) 1,1L - 1,4L	Valeo	SG7S 016	7	70A	5705 AP	-
	Valeo "	SG8B 022 SG9B 064	8	80A	5705 AQ	-
(TU5JP4) 1,6 L 16S	Valeo "	A13VI 283 SG10B 023	9	90A	5705 6E	-

## Diesel - Gasoleo

(DV4TD) 1,4L Turbo (DV4TED4) 1,4L 16S Turbo	Denso "	510 1211 923 104 2103 170	15	150A	5705 AC	-
--	------------	------------------------------	----	------	---------	---

NEUF : NEW - NUEVO - NOVO - NEU - NUOVO - NIEUW

E.S. ECHANGE STANDARD : STANDARD EXCHANGE - CAMBIO ESTANDARD - R.RENOVADO - AUSTAUSCH - REVISIONATO - FABRIEKSRUIL

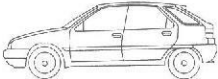
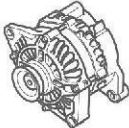
					<b>CITROËN ZX</b>	
	Fournisseur Supplier Provedor Fornecedor Lieferant Fornitore Leverancier	Repère Identification mark Marca Referencia Bauteilmarkierung Riferimento Merkteken	Classe Class Clase Klasse Klasse Klasse	Ampère Ampere Amperios Ampère Ampere Ampere		
					Neuf	E.S.
<b>Essence - Petrol - Gazolina - Gasolina - Benzin - Benzina - Benzine</b>						
(TU1-TU3) <b>1,1 L - 1,4 L</b> Sauf Réfri  <i>Pour Peugeot 306</i>	Valeo " " Bosch	A11VI 37 A11VI 42 A11VI 10 0 120 335 006	5	50A	<b>5705 E1</b> (cl. 7 - 70A)	95 667 741
	Valeo " " Bosch Magnet Marelli "	A11VI 43 A11VI 11 A11VI 55 0 120 335 007 63 321 641 63 321 770	7	70A		5705 X9
(TU1-TU3) <b>1,1 L - 1,4 L Réfri</b>  <i>Pour Peugeot 306</i>	Valeo " " " Magnet Marelli "	A13VI 46 A13VI 83 A13VI 96 A13VI 240 63 321 723 63 321 772	8	80A	<b>5705 E2</b> <b>RP 5705 X2</b> (90A)	5705 Y0
(XU5M-XU9JA- XU9JAZ) <b>1,6 L - 1,9 L</b>  <i>Pour Peugeot 306</i>	Valeo " " " " Bosch Mitsubishi	A11VI 18 A11VI 49 A11VI 23 A11VI 48 A11VI 57 0 123 110 004 A 002T 17491	7	70A	<b>5705 E4</b>	5705 N6
	Valeo " " "	A13VI 48 A13VI 51 A13VI 88 A13VI 86	8	80A	<b>5705 E5</b>	95 667 745

POUR : FOR - PARA - PARA - FÜR - PER - VOOR

NEUF : NEW - NUEVO - NOVO - NEU - NUOVO - NIEUW

E.S. ECHANGE STANDARD : STANDARD EXCHANGE - CAMBIO ESTANDARD - R.RENOVADO - AUSTAUSCH - REVISIONATO - FABRIEKSPUIJL

SAUF REFRI : EXCEPT AIR CONDITIONING - SALVO AIRE ACONDICIONARD - SEM CLIMATIZAÇÃO - AUSSER EINFACHE KLIMA - SALVO REFRIGERAZIONE - BEHALVE AIRCO

REFRI : AIR CONDITIONING - AIRE ACONDICIONARD - SEM CLIMATIZAÇÃO - EINFACHE KLIMA - REFRIGERAZIONE - AIRCO

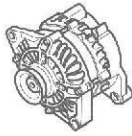

<b>CITROËN ZX</b>						
	Fournisseur Supplier Proveedor Fornecedor Lieferant Fornitore Leverancier	Repère Identification mark Marca Referencia Bauteilmarkierung Riferimento Merkteken	Classe Class Clase Classe Klasse Classe Klasse	Ampère Ampere Amperios Ampère Ampere Ampere		
					Neuf	E.S.
<b>Essence - Petrol - Gazolina - Gazolina - Benzin - Benzina - Benzine</b>						
(XU5JP - XU7JP) <b>1,6L - 1,8L</b> (XU10J2 - XU10J4) <b>2L - 2L 16S</b> Sauf Réfri	Valeo " " " "	A11VI 18 A11VI 48 A11VI 49 A11VI 57 A11VI 23	7	70A	<b>5705 E4</b>	<b>5705 N6</b> (Fix. 3 points)
	Mitsubishi Bosch	A002T 17491 0 123 110 004				
	Valeo " " "	A13VI 48 A13VI 88 A13VI 51 A13VI 86				
<b>Pour Peugeot 306</b>	Valeo " " "	A13VI 81 A13VI 189 A13VI 280 A 002T 37691 A002T A0291	8	80A	<b>5705 E5</b> → 12/93	<b>95 667 745</b> (Fix. 3 points) → 12/93
	Mitsubishi "	A13VI 81 A13VI 189 A13VI 280 A 002T 37691 A002T A0291				
(XU5JP - XU7JP) <b>1,6L - 1,8L Réfri</b>  <b>Pour Peugeot 306</b>	Valeo " " Mitsubishi "	A13VI 81 A13VI 189 A13VI 280 A 002T 37691 A002T A0291	8	80A	<b>5705 E6</b> <b>RP 5705 E7</b> (90A)	<b>5705 M9</b> (Fix. 3 points)
(XU5JP - XU7JP) <b>1,6L - 1,8L</b> (XU10J2 - XU10J4) <b>2L - 2L 16S</b>  <b>Pour Peugeot 306</b>	Valeo " " Mitsubishi "	A 13VI 71 A13VI 191 A13VI 281 A 003T A0591 A 004T 02891	9	90A	<b>5705 E7</b>	<b>5705 N7</b> (Fix. 3 points)
(XU7JP4) <b>1,8L 16S</b> Sauf Réfri	Bosch	0 123 310 013	7	70A	<b>5705 S2</b>	<b>5705 W4</b> (Fix. 4 points)
(XU10J2 - XU10J4RS) <b>2L - 2L 16S</b>  <b>Pour Peugeot 306</b>	Valeo " " Bosch Mitsubishi	A13VI 102 A13VI 232 A13VI 262 0 123 310 011 A 002T A1991	8	80A	<b>5705 S3</b> <b>RP 5705 S4</b> (90A)	<b>5705 W7</b> (Fix. 4 points)
<p><b>POUR :</b> FOR - PARA - PARA - FÜR - PER - VOOR  <b>FIX 3 POINTS :</b> 3-PIN CONNECTIONS - FIJACIONES 3 PUNTOS - FIXAÇÃO 3 PONTOS - 3-PUNKT BEFESTIGUNG - FISSAGGIO 3 PUNTI - 3 PUNTS BEVESTIGINGEN  <b>FIX 4 POINTS :</b> 4-PIN CONNECTIONS - FIJACIONES 4 PUNTOS - FIXAÇÃO 4 PONTOS - 4-PUNKT BEFESTIGUNG - FISSAGGIO 4 PUNTI - 4 PUNTS BEVESTIGINGEN  <b>NEUF :</b> NEW - NUEVO - NOVO - NEU - NUOVO - NIEUW  <b>E.S. EXCHANGE STANDARD :</b> STANDARD EXCHANGE - CAMBIO ESTANDARD - R.RENOVADO - AUSTAUSCH - REVISIONATO - FABRIEKSRUIL  <b>SAUF REFRI :</b> EXCEPT AIR CONDITIONING - SALVO AIRE ACONDICIONARD - SEM CLIMATIZAÇÃO - AUSSER EINFACHE KLIMA - SALVO REFRIGERAZIONE - BEHALVE AIRCO  <b>REFRI :</b> AIR CONDITIONING - AIRE ACONDICIONARD - SEM CLIMATIZAÇÃO - EINFACHE KLIMA - REFRIGERAZIONE - AIRCO</p>						

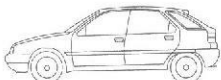
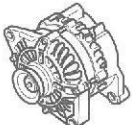
						<b>CITROËN ZX</b>	
	Fournisseur Supplier Proveedor Fornecedor Lieferant Fornitore Leverancier	Repère Identification mark Marca Referencia Bauteilmarkierung Riferimento Merkteken	Classe Class Clase Classe Classe Classe Klasse	Ampère Ampere Amperios Ampère Ampere Ampere Ampere			
					Neuf	E.S.	
<b>Essence - Petrol - Gazolina - Gazolina - Benzin - Benzina - Benzine</b>							
(XU7JP4 - XU10J2 - XU10J4RS) <b>1,8 L 16 S - 2 L - 2 L 16S</b>  <i>Pour Peugeot 306</i>	Valeo " " Mitsubishi	A13VI 101 A13VI 233 A13VI 263 A 002T A2091	9	90A	<b>5705 S4</b>	<b>5705 X0</b> (Fix. 4 points)	
(XU7JP4 - XU10J2 - XU10J4RS) <b>1,8 L 16 S - 2 L - 2 L 16S</b> Réfri  <i>Pour Peugeot 306</i>	Valeo	A14VI 14	12	120A	<b>5705 S5</b>	<b>5705 1T</b>	
<b>Diesel - Gaseleo</b>							
(TUD3) <b>1,4 L</b>  <i>Pour Peugeot 106</i>	Valeo " "	A11VI 38 A11VI 44 A11VI 56	7	70A	<b>5705 J9</b>	<b>5705 M7</b>	
(TUD5) <b>1,5 L</b>  <i>Pour Peugeot 106</i>	Valeo	A11VI 45	7	70A	<b>5705 L1</b>	<b>5705 N1</b>	
	Valeo	A13VI 84	8	80A	<b>5705 L2</b>	<b>5705 N3</b>	
	Valeo "	A13VI 142 A13VI 273	9	90A	<b>5705 X3</b>	<b>5705 1N</b>	
(XUD) <b>1,8 L - 1,9 L → 01/95</b> Sauf Réfri <b>Direction assistée</b>  <i>Pour Peugeot 306</i>	Valeo " " "	A11VI 16 A11VI 47 A11VI 24 A11VI 50	5	50A	<b>5705 F3</b> (cl. 7-70A) (Fix. 3 points)	<b>95 667 740</b>	
	Valeo " " " Bosch	A11VI 17 A11VI 25 A11VI 40 A11VI 51 0120 335 012	7	70A		<b>5705 Y1</b>	
<p>POUR : FOR - PARA - PARA - FÜR - PER - VOOR          FIX 3 POINTS : 3-PIN CONNECTIONS - FIJACIONES 3 PUNTOS - FIXAÇÃO 3 PONTOS - 3-PUNKT BEFESTIGUNG - FISSAGGIO 3 PUNTI - 3 PUNTS BEVESTIGINGEN          FIX 4 POINTS : 4-PIN CONNECTIONS - FIJACIONES 4 PUNTOS - FIXAÇÃO 4 PONTOS - 4-PUNKT BEFESTIGUNG - FISSAGGIO 4 PUNTI - 4 PUNTS BEVESTIGINGEN          NEUF : NEW - NUEVO - NOVO - NEU - NUOVO - NIEUW          E.S. ECHANGE STANDARD : STANDARD EXCHANGE - CAMBIO ESTANDARD - R.RENOVADO - AUSTAUSCH - REVISIONATO - FABRIEKSRIJL          SAUF REFRI : EXCEPT AIR CONDITIONING - SALVO AIRE ACONDICIONARD - SEM CLIMATIZAÇÃO - AUSSER EINFACHE KLIMA - SALVO REFRIGERAZIONE - BEHALVE AIRCO          REFRI : AIR CONDITIONING - AIRE ACONDICIONARD - SEM CLIMATIZAÇÃO - EINFACHE KLIMA - REFRIGERAZIONE - AIRCO          DIRECTION NON ASSISTEE : WITHOUT POWER STEERING - DIRECCION NO ASSISTIDA - DIRECÇÃO NÃO ASSISTIDA - MECHANISCHE LENKUNG - SENZA SERVOSTERZO - ZONDER STUURBEKRACHTIGING          DIRECTION ASSISTEE : POWER STEERING SINCE - DIRECCION ASISTIDA - DIRECÇÃO ASSISTIDA - SERVO-LENKUNG - SERVOSTERZO - STUURBEKRACHTIGING</p>							

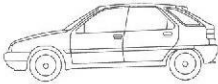
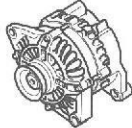
<b>CITROËN ZX</b>						
	Fournisseur Supplier Proveedor Fornecedor Lieferant Fornitore Leverancier	Repère Identification mark Marca Referencia Bauteilmarkierung Riferimento Merkteken	Classe Class Clase Classe Klasse Classe Klasse	Ampère Ampere Amperios Ampère Ampere Ampere		
					Neuf	E.S.
<b>Diesel - Gasoleo</b>						
(XUD) Réfri Direction non assistée  <i>Pour Peugeot 306</i>	Valeo "	A13VI 49 A13VI 87	8	80A	5705 F4	5705 Y2
(XUD) 1,8 L - 1,9 L → 01/95 Réfri Direction assistée  <i>Pour Peugeot 306</i>	Valeo "	A13VI 31 A13VI 85	8	80A	5705 E3 (Fix. 3 points)	95 667 749
(XUD) 1,8 L - 1,9 L 01/95 → Direction assistée	Valeo " " Mitsubishi Bosch	A13VI 230 A13VI 260 A13VI 95 A 002T A1994 0 123 310 010	8	80A	5705 L6 RP 5705 L7 (90A) (Fix. 4 points)	5705 R5
	Valeo " " Mitsubishi	A13VI 231 A13VI 261 A13VI 94 A 002T A2094	9	90A	5705 L7 (Fix. 4 points)	5705 R7
	Valeo Mitsubishi	A14VI 13 A 003T A5591	12	120A	5705 K7	5705 1Q
(XUD) 1,8 L - 1,9 L 06/95 → Sauf Réfri Direction assistée  <i>Pour Peugeot 306</i>	Bosch	0 123 310 012	7	70A	5705 L5	5705 X7

POUR : FOR - PARA - PARA - FÜR - PER - VOOR  
NEUF : NEW - NUEVO - NOVO - NEU - NUOVO - NIEUW  
E.S. EXCHANGE STANDARD : STANDARD EXCHANGE - CAMBIO ESTANDARD - R.RENOVADO - AUSTAUSCH - REVISIONATO - FABRIEKSRIJL  
SAUF REFRI : EXCEPT AIR CONDITIONING - SALVO AIRE ACONDICIONARD - SEM CLIMATIZAÇÃO - AUSSER EINFACHE KLIMA - SALVO REFRIGERAZIONE - BEHALVE AIRCO  
REFRI : AIR CONDITIONING - AIRE ACONDICIONARD - SEM CLIMATIZAÇÃO - EINFACHE KLIMA - REFRIGERAZIONE - AIRCO  
DIRECTION NON ASSISTEE : WITHOUT POWER STEERING - DIRECCION NO ASSISTIDA - DIRECÇÃO NÃO ASSISTIDA - MECHANISCHE LENKUNG - SENZA SERVOSTERZO - ZONDER STUURBEKRACHTIGING  
DIRECTION ASSISTEE : POWER STEERING SINCE - DIRECCION ASISTIDA - DIRECÇÃO ASSISTIDA - SERVO-LENKUNG - SERVOSTERZO - STUURBEKRACHTIGING  
FIX 3 POINTS : 3-PIN CONNECTIONS - FIJACIONES 3 PUNTOS - FIXAÇÃO 3 PONTOS - 3-PUNKT BEFESTIGUNG - FISSAGGIO 3 PUNTI - 3 PUNTS BEVESTIGINGEN  
FIX 4 POINTS : 4-PIN CONNECTIONS - FIJACIONES 4 PUNTOS - FIXAÇÃO 4 PONTOS - 4-PUNKT BEFESTIGUNG - FISSAGGIO 4 PUNTI - 4 PUNTS BEVESTIGINGEN



# CITROËN XSARA

→ 27/08/2000

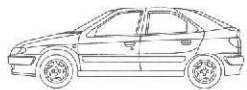
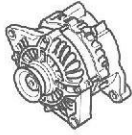
	Fournisseur Supplier Proveedor Fornecedor Lieferant Fornitore Leverancier	Repère Identification mark Marca Referencia Bauteilmarkierung Riferimento Merkteken	Classe Class Clase Classe Classe Klasse	Ampère Ampere Amperios Ampère Ampere Ampere		
					Neuf	E.S.
<b>Essence - Petrol - Gazolina - Gazolina - Benzin - Benzina - Benzine</b>						
(TU3JP) 1,4 L Sauf Réfri Direction non assistée  <i>Pour Peugeot 306</i>	Valeo " " Bosch Magnet Marelli "	A11VI 11 A11VI 43 A11VI 55 0 120 335 007 63 321 641 63 321 770	7	70A	5705 E1	5705 X9
(TU3JP) 1,4 L Sauf Réfri Direction assistée  <i>Pour Peugeot 306</i>	Valeo Magnet Marelli "	A11VI 89 63 321 671 63 321 771	7	70A	5705 1J	5705 1Y
	Valeo " " Magnet Marelli "	A13VI 46 A13VI 83 A13VI 96 63 321 723 63 321 772	8	80A	5705 E2 RP5705 X2 (90A)	5705 Y0
(TU3JP) 1,4L Réfri   (TU5JP) 1,6 L  <i>Pour Peugeot 306</i>	Valeo Magnet Marelli "	A11VI 89 63 321 671 63 321 771	7	70A	5705 1J	5705 1Y
	Valeo " " Magnet Marelli "	A13VI 46 A13VI 83 A13VI 96 63 321 723 63 321 772	8	80A	5705 E2 RP5705 X2 (90A)	5705 Y0
	Valeo	A13VI 141	9	90A	5705 X2	5705 1L
(XU7JP) 1,8 L  <i>Pour Peugeot 306</i>	Valeo " " Mitsubishi "	A13VI 81 A13VI 189 A13VI 280 A 002 T 37691 A 002 TA 0291	8	80A	5705 E6 RP 5705 E7 (90A)	5705 M9
	Valeo " " Mitsubishi "	A13VI 71 A13VI 191 A13VI 281 A 004 T 02891 A 003 TA 0591	9	90A	5705 E7	5705 N7

POUR : FOR - PARA - PARA - FÜR - PER - VOOR

NEUF : NEW - NUEVO - NOVO - NEU - NUOVO - NIEUW

E.S. ECHANGE STANDARD : STANDARD EXCHANGE - CAMBIO ESTANDARD - R.RENOVADO - AUSTAUSCH - REVISIONATO - FABRIEKSRUIL

SAUF REFRI : EXCEPT AIR CONDITIONING - SALVO AIRE ACONDICIONARD - SEM CLIMATIZAÇÃO - AUSSER EINFACHE KLIMA - SALVO REFRIGERAZIONE - BEHALVE AIRCO

REFRI : AIR CONDITIONING - AIRE ACONDICIONARD - SEM CLIMATIZAÇÃO - EINFACHE KLIMA - REFRIGERAZIONE - AIRCO

DIRECTION NON ASSISTEE : WITHOUT POWER STEERING - DIRECCION NO ASSISTIDA - DIRECÇÃO NÃO ASSISTIDA - MECHANISCHE LENKUNG - SENZA SERVOSTERZO -

ZONDER STUURBEKRACHTIGING

DIRECTION ASSISTEE : POWER STEERING SINCE - DIRECCION ASISTIDA - DIRECÇÃO ASSISTIDA - SERVO-LENKUNG - SERVOSTERZO - STUURBEKRACHTIGING

**CITROËN XSARA**

→ 27/08/2000

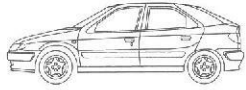
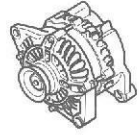
	Fournisseur Supplier Provedor Fornecedor Lieferant Fornitore Leverancier	Repère Identification mark Marca Referencia Bauteilmarkierung Riferimento Merkteken	Classe Class Clase Classe Klasse Classe Klasse	Ampère Ampere Amperios Ampère Ampere Ampere Ampere		
					Neuf	E.S.
<b>Essence - Petrol - Gazolina - Gazolina - Benzin - Benzina - Benzine</b>						
(XU7JP) <b>1,8L Réfri</b>  <i>Pour Peugeot 605</i>	Mitsubishi "	A 004 T 03491 A 004 TA 0091	12	120A	<b>5705 E8</b>	<b>5705 7K</b>
(XU7JB – XU7JP4 ) <b>1,8 L – 1,8 L 16S</b> Sauf Réfri (XU10J4R – XU10J4RS) <b>2 L 16S</b>  <i>Pour Peugeot 306</i>	Bosch	0 123 310 013	7	70A	<b>5705 S2</b>	<b>5705 W4</b>
	Valeo " " Bosch Mitsubishi	A13VI 102 A13VI 232 A13VI 262 0 123 310 011 A 002 TA 1991	8	80A	<b>5705 S3</b> <b>RP 5705 S4</b> (90A)	<b>5705 W7</b>
(XU7JB – XU7JP4 ) <b>1,8L – 1,8L 16S</b> (XU10J4R – XU10J4RS) <b>2L 16S</b>  <i>Pour Peugeot 306</i>	Valeo " " Mitsubishi	A13VI 101 A13VI 233 A13VI 263 A 002 TA 2091	9	90A	<b>5705 S4</b>	<b>5705 X0</b>

POUR : FOR - PARA - PARA - FÜR - PER - VOOR

NEUF : NEW - NUEVO - NOVO - NEU - NUOVO - NIEUW

E.S. ECHANGE STANDARD : STANDARD EXCHANGE - CAMBIO ESTANDARD - R.RENOVADO - AUSTAUSCH - REVISIONATO - FABRIEKSRUIL

SAUF REFRI : EXCEPT AIR CONDITIONING - SALVO AIRE ACONDICIONARD - SEM CLIMATIZAÇÃO - AUSSER EINFACHE KLIMA - SALVO REFRIGERAZIONE - BEHALVE AIRCO

REFRI : AIR CONDITIONING - AIRE ACONDICIONARD - SEM CLIMATIZAÇÃO - EINFACHE KLIMA - REFRIGERAZIONE - AIRCO

DIRECTION NON ASSISTEE : WITHOUT POWER STEERING - DIRECCION NO ASSISTIDA - DIRECÇÃO NÃO ASSISTIDA - MECHANISCHE LENKUNG - SENZA SERVOSTERZO - ZONDER STUURBEKRACHTIGING

DIRECTION ASSISTEE : POWER STEERING SINCE - DIRECCION ASISTIDA - DIRECÇÃO ASSISTIDA - SERVO-LENKUNG - SERVOSTERZO - STUURBEKRACHTIGING

# CITROËN XSARA

→ 27/08/2000

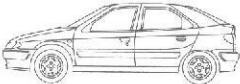
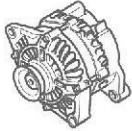
	Fournisseur Supplier Proveedor Fornecedor Lieferant Fornitore Leverancier	Repère Identification mark Marca Referencia Bauteilmarkierung Riferimento Merkteken	Classe Class Clase Classe Classe Classe	Ampère Ampere Amperios Ampère Ampere Ampere		
					Neuf	E.S.
<b>Diesel - Gasoleo</b>						
(TUD5) 1,5L	Valeo	A11VI 45	7	70A	5705 L1	5705 N1
<i>Pour Peugeot 306</i>	Valeo	A13VI 84	8	80A	5705 L2	5705 N3
(XUD7 - XUD9) 1,8L - 1,9L Sauf Réfri Direction non assistée	Valeo " " " Bosch	A11VI 17 A11VI 25 A11VI 40 A11VI 51 0 120 335 012	7	70A	5705 F3	5705 Y1
<i>Pour Peugeot 306</i>	Valeo "	A13VI 49 A13VI 87	8	80A	5705 F4	5705 Y2
(XUD7 - XUD9) 1,8L - 1,9L Sauf Réfri Direction assistée	Bosch	0 123 310 012	7	70A	5705 L5	5705 X7
<i>Pour Peugeot 306</i>	Valeo " " Bosch Mitsubishi	A13VI 95 A13VI 230 A13VI 260 0 123 310 010 A 002 TA 1994	8	80A	5705 L6 RP 5705 L7 (90A)	5705 R5
<i>Pour Peugeot 306</i>	Valeo " " Mitsubishi	A13VI 94 A13VI 231 A13VI 261 A 002 TA 2094	9	90A	5705 L7	5705 R7
(XUD7 - XUD9) 1,8L - 1,9L Réfri	Valeo Mitsubishi	A14VI 13 A 003 TA 5591	12	120A	5705 K7	5705 1Q
<i>Pour Peugeot 306-406</i>						
<p>POUR : FOR - PARA - PARA - FÜR - PER - VOOR  NEUF : NEW - NUEVO - NOVO - NEU - NUOVO - NIEUW  E.S. ECHANGE STANDARD : STANDARD EXCHANGE - CAMBIO ESTANDARD - R.RENOVADO - AUSTAUSCH - REVISIONATO - FABRIEKSRIJL  SAUF REFRI : EXCEPT AIR CONDITIONING - SALVO AIRE ACONDICIONARD - SEM CLIMATIZAÇÃO - AUSSER EINFACHE KLIMA - REFRIGERAZIONE - BEHALVE AIRCO  REFRI : AIR CONDITIONING - AIRE ACONDICIONARD - SEM CLIMATIZAÇÃO - EINFACHE KLIMA - REFRIGERAZIONE - AIRCO  DIRECTION NON ASSISTEE : WITHOUT POWER STEERING - DIRECCION NO ASSISTIDA - DIRECÇÃO NÃO ASSISTIDA - MECHANISCHE LENKUNG - SENZA SERVOSTERZO - ZONDER STUURBEKRACHTIGING  DIRECTION ASSISTEE : POWER STEERING SINCE - DIRECCION ASISTIDA - DIRECÇÃO ASSISTIDA - SERVO-LENKUNG - SERVOSTERZO - STUURBEKRACHTIGING</p>						

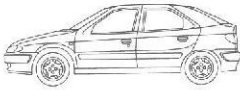
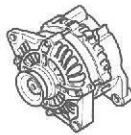

<b>CITROËN XSARA</b> → 27/08/2000						
	Fournisseur Supplier Provedor Fornecedor Lieferant Fornitore Leverancier	Repère Identification mark Marca Referencia Bauteilmarkierung Riferimento Merkteken	Classe Class Clase Classe Classe Klasse	Ampère Amperios Ampère Ampere Ampere		
					Neuf	E.S.
<b>Diesel - Gasoleo</b>						
(DW8) 1,9L Sauf Réfri  <i>Pour Peugeot 306</i>	Valeo " "	A11VI 91 SG7S 014 SG7S 024	7	70A	5705 2A	5705 4T
	Valeo " Mitsubishi "	A13VI 203 SG8B 020 A 002 TB 2191 A 002 TB 4791	8	80A	5705 2B RP 5705 2C (90A)	5705 4V
(DW8) 1,9L Réfri  <i>Pour Peugeot 306</i>	Valeo " Mitsubishi "	A13VI 203 SG8B 020 A 002 TB 2191 A 002 TB 4791	8	80A	5705 2B RP 5705 2C (90A)	5705 4V
	Valeo " Mitsubishi "	A13VI 204 SG10B 021 A 002 TB 2291 A 002 TB 4891	9	90A	5705 2C	5705 4X
(DW8) 1,9L Réfri Direction assistée <i>Pour Peugeot 306</i>	Valeo Mitsubishi "	SG12S 055 A 003 TA 6491 A 003 TB 0891	12	120A	5705 2D	5705 4Z
(DW10TD) 2L Turbo Sauf Réfri  <i>Pour Peugeot 306</i>	Valeo " Mitsubishi "	A13VI 204 SG10B 021 A 002 TB 2291 A 002 TB 4891	9	90A	5705 2C	5705 4X
	Valeo Mitsubishi "	SG12S 055 A 003 TA 6491 A 003 TB 0891	12	120A	5705 2D	5705 4Z
(DW10TD) 2L Turbo Réfri  <i>Pour Peugeot 306</i>	Valeo Mitsubishi "	SG12S 055 A 003 TA 6491 A 003 TB 0891	12	120A	5705 2D	5705 4Z
	Valeo " " " Bosch Mitsubishi	A14VI 27 A14VI 42 SG15S 016 SG15S 021 0 124 615 002 A 004 TF 0091	15	150A	5705 4F	5705 5J
<p>POUR : FOR - PARA - PARA - FÜR - PER - VOOR  NEUF : NEW - NUEVO - NOVO - NEU - NUOVO - NIEUW  E.S. ECHANGE STANDARD : STANDARD EXCHANGE - CAMBIO ESTANDARD - R.RENOVADO - AUSTAUSCH - REVISIONATO - FABRIEKSRUIJ  SAUF REFRI : EXCEPT AIR CONDITIONING - SALVO AIRE ACONDICIONARD - SEM CLIMATIZAÇÃO - AUSSER EINFACHE KLIMA - SALVO REFRIGERAZIONE - BEHALVE AIRCO  REFRI : AIR CONDITIONING - AIRE ACONDICIONARD - SEM CLIMATIZAÇÃO - EINFACHE KLIMA - REFRIGERAZIONE - AIRCO  DIRECTION ASSISTEE : POWER STEERING SINCE - DIRECCION ASISTIDA - DIRECÇÃO ASSISTIDA - SERVO-LENKUNG - SERVOSTERZO - STUURBEKRACHTIGING</p>						

# CITROËN XSARA

## 28/08/2000 →

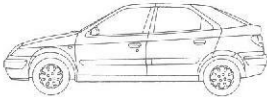
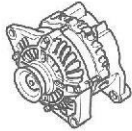
	Fournisseur Supplier Provedor Fornecedor Lieferant Fornitore Leverancier	Repère Identification mark Marca Referencia Bauteilmarkierung Riferimento Merkteken	Classe Class Classe Classe Klasse Klasse	Ampère Ampere Amperios Ampère Ampere Ampere		
					Neuf	E.S.
<b>Essence - Petrol - Gazolina - Gazolina - Benzin - Benzina - Benzine</b>						
(TU3JP - TU5JP4) <b>1,4 L - 1,6L 16S</b> Sauf Réfri  <i>Pour Peugeot 306</i>	Valeo " Mitsubishi Denso	A11VI 106 SG7S 015 A 005 TA 6291 63 321 733	7	70A	<b>5705 5T</b>	<b>5705 6Z</b>
(TU3JP - TU5JP4) <b>1,4 L - 1,6L 16S</b> (Avec cic +cp)  <i>Pour Peugeot 306</i>	Valeo " " Mitsubishi Magneti Marelli	A13VI 276 SG8B 021 SG9B 063 A 005 TA 6391 63 321 734	8	80A	<i>5705 5U</i> <b>RP 5705 5V</b> (90A)	<b>5705 7C</b>
	Valeo "	A13VI 277 SG10B 022	9	90A	<b>5705 5V</b>	<b>5705 7F</b>
(EW10J4) <b>2L 16S</b> (Avec cic)  <i>Pour Peugeot 306</i>	Valeo " Mitsubishi "	A13VI 203 SG8B 020 A 002 TB 2191 A 002 TB 4791	8	80A	<i>5705 2B</i> <b>RP 5705 2C</b> (90A)	<b>5705 4V</b>
	Valeo " Mitsubishi "	A13VI 204 SG10B 021 A 002 TB 2291 A 002 TB 4891	9	90A	<b>5705 2C</b>	<b>5705 4X</b>
	Valeo Mitsubishi "	SG12S 055 A 003 TA 6491 A 003 TB 0891	12	12A	<b>5705 2D</b>	<b>5705 4Z</b>
(XU10J4RS) <b>2 L 16S</b>  <i>Pour Peugeot 306</i>	Bosch	0 123 310 013	7	70A	<b>5705 S2</b>	<b>5705 W4</b>
	Valeo " " Bosch Mitsubishi	A13VI 102 A13VI 232 A13VI 262 0 123 310 011 A 002 TA 1991	8	80A	<i>5705 S3</i> <b>RP 5705 S4</b> (90A)	<b>5705 W7</b>
	Valeo " " Mitsubishi	A13VI 101 A13VI 233 A13VI 263 A 002 TA 2091	9	90A	<b>5705 S4</b>	<b>5705 X0</b>

POUR : FOR - PARA - PARA - FÜR - PER - VOOR

AVEC CIC+CP - AVEC CONNECTION INFO CHARGE + CHARGE PROGRESSIVE: WITH LOAD INFORMATION CONNECTION + VARIABLE OUTPUT - CON CONEXION INFO CARGA + CARGA PROGRESIVA - COM CONECCÃO INFO CARGA + CARGA PROGRESSIVA - MIT ANSCHLUSS LADEZUSTANDSANZEIGE + PROGRESSIVE LASTANPASSUNG CON CONNESSIONE INFO CARICO + CARICO PROGRESSIVO - MET AANSLUITING OPLAADINFO + PROGRESSIEVE LADING

AVEC CIC - AVEC CONNECTION INFO CHARGE : WITH LOAD INFORMATION CONNECTION - CON CONEXION INFO CARGA - COM CONECCÃO INFO CARGA - MIT ANSCHLUSS LADEZUSTANDSANZEIGE - CON CONNESSIONE INFO CARICO - MET AANSLUITING OPLAADINFO

NEUF : NEW - NUEVO - NOVO - NEU - NUOVO - NIEUW

E.S. ECHANGE STANDARD : STANDARD EXCHANGE - CAMBIO ESTANDARD - R.RENOVADO - AUSTAUSCH - REVISIONATO - FABRIEKSRUIL

SAUF REFRI : EXCEPT AIR CONDITIONING - SALVO AIRE ACONDICIONARD - SEM CLIMATIZAÇÃO - AUSSER EINFACHE KLIMA - SALVO REFRIGERAZIONE - BEHALVE AIRCO

**CITROËN XSARA**

28/08/2000 →

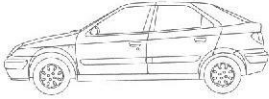
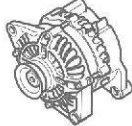
	Fournisseur Supplier Proveedor Fornecedor Lieferant Fornitore Leverancier	Repère Identification mark Marca Referencia Bauteilmarkierung Riferimento Merkteken	Classe Class Clase Classe Klasse Classe Klasse	Ampère Ampere Amperios Ampère Ampere Ampere Ampere		
					Neuf	E.S.
<b>Diesel - Gasoleo</b>						
(DV4TD) 1,4 L Turbo	Denso "	1042 103 170 5101 211 923	15	150A	5705 AC	-
(DW8B) 1,9L Sauf Réfri  <i>Pour Peugeot 306</i>	Valeo " "	A11VI 91 SG7S 014 SG7S 024	7	70A	5705 2A	5705 4T
	Valeo " Mitsubishi "	A13VI 203 SG8B 020 A 002 TB 2191 A 002 TB 4791	8	80A	5705 2B RP 5705 2C (90A)	5705 4V
(DW8B) 1,9L Réfri  <i>Pour Peugeot 306</i>	Valeo " Mitsubishi "	A13VI 203 SG8B 020 A 002 TB 2191 A 002 TB 4791	8	80A	5705 2B RP 5705 2C (90A)	5705 4V
	Valeo " Mitsubishi "	A13VI 204 SG10B 021 A 002 TB 2291 A 002 TB 4891	9	90A	5705 2C	5705 4X
	Valeo Mitsubishi "	SG12S 055 A 003 TA 6491 A 003 TB 0891	12	120A	5705 2D	5705 4Z
(DW10) 2L Turbo Sauf Réfri <i>Pour Peugeot 306</i>	Valeo " Mitsubishi "	A13VI 204 SG10B 021 A 002 TB 2291 A 002 TB 4891	9	90A	5705 2C	5705 4X
(DW10) 2L Turbo <i>Pour Peugeot 306</i>	Valeo Mitsubishi "	SG12S 055 A 003 TA 6491 A 003 TB 0891	12	120A	5705 2D	5705 4Z
(DW10) 2L Turbo BVM BVA → 06/2001 <i>Pour Peugeot 306</i>	Valeo " " " Bosch Mitsubishi	A14VI 27 A14VI 42 SG15S 016 SG15S 021 0 124 615 002 A 004 TF 0091	15	150A	5705 4F	5705 5J
(DW10) 2L Turbo BVA 06/2001 → <i>Pour Peugeot 306</i>	Valeo " " " Bosch	A14VI 35 A14VI 41 SG15S 022 SG15S 018 0 124 615 027	15	150A	5705 AA	5702 A1

POUR : FOR - PARA - PARA - FÜR - PER - VOOR

NEUF : NEW - NUEVO - NOVO - NEU - NUOVO - NIEUW

E.S. ECHANGE STANDARD : STANDARD EXCHANGE - CAMBIO ESTANDARD - R.RENOVADO - AUSTAUSCH - REVISIONATO - FABRIEKSRUIJ

SAUF REFRI : EXCEPT AIR CONDITIONING - SALVO AIRE ACONDICIONARD - SEM CLIMATIZAÇÃO - AUSSER EINFACHE KLIMA - SALVO REFRIGERAZIONE - BEHALVE AIRCO

REFRI : AIR CONDITIONING - AIRE ACONDICIONARD - SEM CLIMATIZAÇÃO - EINFACHE KLIMA - REFRIGERAZIONE - AIRCO



# CITROËN XSARA PICASSO

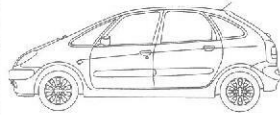

Fournisseur  
Supplier  
Proveedor  
Fornecedor  
Lieferant  
Fornitore  
Leverancier

Repère  
Identification mark  
Marca  
Referencia  
Bauteilmarkierung  
Riferimento  
Merktelen

Classe  
Class  
Clase  
Classe  
Klasse  
Klasse  
Klasse

Ampère  
Ampere  
Amperios  
Ampère  
Ampere  
Ampere  
Ampere

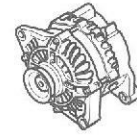

Neuf

E.S.

Essence - Petrol - Gazolina - Gazolina - Benzin - Benzina - Benzine

(TU5JP)(90CV) 1,6L Sauf Réfri  <i>Pour Peugeot 206</i>	Valeo " "	A11VI 91 SG7S 014 SG7S 024	7	70A	5705 2A	5705 4T
	Valeo Mitsubishi "	A13VI 203 SG8B 020 A 002 TB 2191 A 002 TB 4791	8	80A	5705 2B RP 5705 2C (90A)	5705 4V
(TU5JP)(100CV) 1,6L Sauf Réfri  <i>Pour Peugeot 206</i>	Valeo Mitsubishi Denso	A11VI 106 SG7S 015 A 005 TA 6291 63 321 733	7	70A	5705 5T	5705 6Z
(TU5JP) 1,6L  <i>Pour Peugeot 206</i>	Valeo " " Mitsubishi Magneti Marelli	A13VI 276 SG8B 021 SG9B 063 A 005 TA 6391 63 321 734	8	80A	5705 5U RP 5705 5V (90A)	5705 7C
	Valeo "	A13VI 277 SG10B 022	9	90A	5705 5V	5705 7F
(EW7J4) 1,8L 16S  <i>Pour Peugeot 206</i>	Valeo Mitsubishi "	A13VI 203 SG8B 020 A 002 TB 2191 A002 TB 4791	8	80A	5705 2B RP 5705 2C (90A) → 04/2000	5705 4V → 04/2000
	Valeo " " Mitsubishi Magneti Marelli	A13VI 276 SG8B 021 SG9B 063 A 005 TA 6391 63 321 734	8	80A	5705 5U RP 5705 5V (90A) 05/2000 →	5705 7C 05/2000 →
	Valeo Mitsubishi "	A13VI 204 SG10B 021 A 002 TB 2291 A002 TB 4891	9	90A	5705 2C → 04/2000	5705 4X → 04/2000
	Valeo "	A13VI 277 SG10B 022	9	90A	5705 5V 05/2000 →	5705 7F 05/2000 →
	Valeo Mitsubishi "	SG12S 055 A 003 TA 6491 A 003 TB 0891	12	120A	5705 2D	5705 4Z
(EW10J4) 2L 16S	Valeo	SG12S 051	12	120A	5705 6N	-

POUR : FOR - PARA - PARA - FÜR - PER - VOOR

NEUF : NEW - NUEVO - NOVO - NEU - NUOVO - NIEUW

E.S. ECHANGE STANDARD : STANDARD EXCHANGE - CAMBIO ESTANDARD - R.RENOVADO - AUSTAUSCH - REVISIONATO - FABRIEKSRUIJ

SAUF REFRI : EXCEPT AIR CONDITIONING - SALVO AIRE ACONDICIONARD - SEM CLIMATIZAÇÃO - AUSSER EINFACHE KLIMA - SALVO REFRIGERAZIONE - BEHALVE AIRCO

REFRI : AIR CONDITIONING - AIRE ACONDICIONARD - SEM CLIMATIZAÇÃO - EINFACHE KLIMA - REFRIGERAZIONE - AIRCO

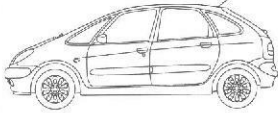
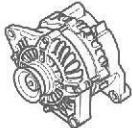
<b>CITROËN XSARA PICASSO</b>						
	Fournisseur Supplier Proveedor Fornecedor Lieferant Fornitore Leverancier	Repère Identification mark Marca Referencia Bauteilmarkierung Riferimento Merkteken	Classe Class Clase Classe Klasse Klasse	Ampère Ampere Amperios Ampère Ampere Ampere		
					Neuf	E.S.
<b>Diesel - Gasoleo</b>						
(DW10TD) <b>2L Turbo Sauf Réfri</b>  <i>Pour Peugeot 206</i>	Valeo " Mitsubishi "	A13VI 204 SG10B 021 A 002 TB 2291 A 002 TB 4891	9	90A	<b>5705 2C</b>	<b>5705 4X</b>
(DW10TD) <b>2L Turbo Réfri</b> 01/2001 →	Valeo	SG12S 055	12	120A	<b>5705 8J</b>	-
(DW10TD) <b>2L Turbo</b>  <i>Pour Peugeot 206</i>	Valeo Mitsubishi "	SG12S 055 A 003 TA 6491 A 003 TB 0891	12	120A	<b>5705 2D</b>	<b>5705 4Z</b>
	Valeo " " " Bosch Mitsubishi	A14VI 27 A14VI 42 SG15S 016 SG15S 021 0 124 615 002 A 004 TF 0091	15	150A	<b>5705 4F</b>	<b>5705 5J</b>

POUR : FOR - PARA - PARA - FÜR - PER - VOOR

NEUF : NEW - NUEVO - NOVO - NEU - NUOVO - NIEUW

E.S. ECHANGE STANDARD : STANDARD EXCHANGE - CAMBIO ESTANDARD - R.RENOVADO - AUSTAUSCH - REVISIONATO - FABRIEKSRUIJ

SAUF REFRI : EXCEPT AIR CONDITIONING - SALVO AIRE ACONDICIONARD - SEM CLIMATIZAÇÃO - AUSSER EINFACHE KLIMA - SALVO REFRIGERAZIONE - BEHALVE AIRCO

REFRI : AIR CONDITIONING - AIRE ACONDICIONARD - SEM CLIMATIZAÇÃO - EINFACHE KLIMA - REFRIGERAZIONE - AIRCO

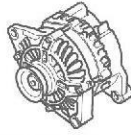
						<b>CITROËN BX</b>	
	Fournisseur Supplier Proveedor Fornecedor Lieferant Fornitore Leverancier	Repère Identification mark Marca Referencia Bauteilmarkierung Riferimento Merktelen	Classe Class Clase Classe Klasse Klasse	Ampère Ampere Amperios Ampère Ampere Ampere			
					Neuf	E.S.	
<b>Essence - Petrol - Gazolina - Gazolina - Benzin - Benzina - Benzine</b>							
(XW7) 1,1 L (l) (GR) → 05/88 (XY7 - TU3) 1,4 L → 05/88  <i>Pour Peugeot 205</i>	Paris-Rhône " Bosch "	A13N 38 A13N 43 0 120 489 194 0 120 489 164	5	50A	5705 11	5705 Z1	
(TU1) 1,1 L (l) (GR) 05/88 → 09/91  (TU3) 1,4 L 05/88 → 09/91  <i>Pour Peugeot 205- 309-405</i>	Mitsubishi Bosch " " Paris-Rhône " "	A 001T 02674 0 120 489 467 0 120 489 476 9 120 144 243 A13N 129 A13N 175 A13N 215	5	50A	5705 89	5705 Z3	
(TU3) 1,4 L 10/91 → <b>Carter cylindre fonte</b>	Valeo " " Bosch	A11VI 10 A11VI 37 A11VI 42 0 120 335 006	5	50A	5705 E1	95 667 741	
	Valeo " " Bosch Magneti Marelli "	A11VI 11 A11VI 43 A11VI 55 0 120 335 007 63 321 641 63 321 770	7	70A		5705 X9	
(TU3) 1,4 L Export (SF) (N) (S) 05/88 → 10/91	Valeo " Paris-Rhône	A13N 176 A13N 216 A13N 130	7	70A	5705 90	95 668 060	
(TU3) 1,4 L → 05/88 (CH) (S)  <i>Pour Peugeot 205</i>	Motorola	2 940 356	5	50A	5705 88 NFP	-	
<p>POUR : FOR - PARA - PARA - FÜR - PER - VOOR  EXPORT : EXPORT - EXPORTACION - EXPORTAÇÃO - EXPORT - EXPORT - EXPORT  NEUF : NEW - NUEVO - NOVO - NEU - NUOVO - NIEUW  E.S. ECHANGE STANDARD : STANDARD EXCHANGE - CAMBIO ESTANDARD - R.RENOVADO - AJUSTAUSCH - REVISIONATO - FABRIEKSRIJL  CARTER CYLINDRE FONTE : CYLINDER BLOCK CAST IRON - BLOQUE CILINDRO FUNDICION - ZYLINDERBLOCK GUSS - CILINDRO DO CARTER FUNDID - CARTER CILIN  DRO GHISA - MOTORCARTER GIETIJZER</p>							

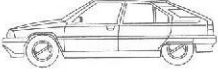
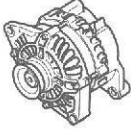
<b>CITROËN BX</b>						
	Fournisseur Supplier Proveedor Fornecedor Lieferant Fornitore Leverancier	Repère Identification mark Marca Referencia Bauteilmarkierung Riferimento Merkteken	Classe Class Clase Classe Klasse Klasse	Ampère Amperios Ampère Ampere Ampere		
					Neuf	E.S.
<b>Essence - Petrol - Gazolina - Gazolina - Benzin - Benzina - Benzine</b>						
(XU) 1,6 L - 1,9 L Sauf Réfri Sauf Pays froids  <i>Pour peugeot 205-305-309-405</i>	Valeo " Paris-Rhône " Mitsubishi " Bosch " " "	A13N 218 A13N 240 A13N 181 A13N 95 A 002T 26391 A 002T 27091 0 120 488 215 0 120 488 214 0 120 489 158 0 120 489 259	5	50A	5705 25	5705 Z0
(XU) 1,6 L - 1,9 L Sauf 16 soupapes Réfri Pays froids Poulie 4 Gorges  <i>Pour Peugeot 205-305-309-406</i>	Mitsubishi "	A 003T 03291 A 003T 45291	8	80A	5705 G7 RP 5705 A0	-
(XU) 1,9 L 16 soupapes Réfri Pays froids Poulie 5 Gorges  <i>Pour Peugeot 205-309-405-504</i>	Mitsubishi " " " " " "	A 002T 34598 A 003T 03291 A 003T 03292 A 003T 03298 A 003T 45191 A 003T 45291 A 003T 45298	8	80A	5705 A0	5705 R8
<p>POUR : FOR - PARA - PARA - FÜR - PER - VOOR  NEUF : NEW - NUEVO - NOVO - NEU - NUOVO - NIEUW  E.S. ECHANGE STANDARD : STANDARD EXCHANGE - SEM CLIMATIZAÇÃO - EINFACHE KLIMA - REFRIGERAZIONE - AIRCO  REFRI : AIR CONDITIONING - AIRE ACONDICIONARD - SEM CLIMATIZAÇÃO - EINFACHE KLIMA - REFRIGERAZIONE - AIRCO  PAYS FROIDS : COLD COUNTRIES - PAISES FRIOS - PAISES FRIOS - KALTE LANDER - PAESI FREDDI - KOUDE LANDEN  SAUF REFRI : EXCEPT AIR CONDITIONING - SALVO AIRE ACONDICIONARD - SEM CLIMATIZAÇÃO - AUSSER EINFACHE KLIMA - SALVO REFRIGERAZIONE - BEHALVE AIRCO  SAUF PAYS FROIDS : EXCEPT COLD COUNTRIES - SALVO PAISES FRIOS - AUSSER KALTE LANDER - SALVO PAESI FREDDI - BEHALVE KOUDE LANDEN  POULIE 5 GORGES : 4 GROOVES PULLEY - POLEA 4 GARGANTAS - ROLDANA 4 GOLA - RIEMENSCHIEBE 4 RILLEN - PULEGGIA 4 GOLE - POUIJE 4 GROEF  POULIE 5 GORGES : 5 GROOVES PULLEY - POLEA 5 GARGANTAS - ROLDANA 5 GOLA - RIEMENSCHIEBE 5 RILLEN - PULEGGIA 4 GOLE - POUIJE 5 GROEF</p>						

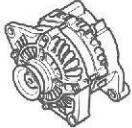

					<b>CITROËN BX</b>	
	Fournisseur Supplier Proveedor Fornecedor Lieferant Fornitore Leverancier	Repère Identification mark Marca Referencia Bauteilmarkierung Riferimento Merkteken	Classe Class Clase Classe Classe Classe	Ampère Ampere Amperios Ampère Ampere Ampere		
					Neuf	E.S.
<b>Diesel - Gasoleo</b>						
(XUD) 1,8 L - 1,9 L Atmo  <i>Pour Peugeot 205-305-309-405</i>	Valeo " Paris-Rhône " Mitsubishi " Bosch " "	A13N 218 A13N 240 A13N 181 A13N 95 A 002T 26391 A 002T 27091 0 120 488 215 0 120 489 158 0 120 489 259	5	50A	5705 25	5705 Z0
(XUD) 1,8 L - 1,9 L Atmo  <i>Pour Peugeot 306-405</i>	Bosch Valeo " " "	0 120 335 012 A11VI 17 A11VI 25 A11VI 40 A11VI 51	7	70A	5705 F3	5705 Y1
(XUD-XUDT) 1,9 L Atmo Réfri 1,8 L Turbo Réfri	Mitsubishi " " " " "	A 002T 34598 A 003T 03291 A 003T 03292 A 003T 03298 A 003T 45191 A 003T 45291 A 003T 45298	8	80A	5705 A0	5705 R8
(XUD) 1,9 L Atmo	Valeo " " " " " Bosch Mitsubishi	A11VI 15 A11VI18 A11VI 23 A11VI 48 A11VI 49 A11VI 57 0 123 110 004 A 002T 17491	7	70A	5705 E4	95 668 061 RP 5705 N6
(XUDT) 1,8 L Turbo  <i>Pour Peugeot 405</i>	Valeo Paris-Rhône " Bosch	A13N 219 A13N 167 A13N 182 0 120 488 129	5	50A	5705 97	5705 Z4
<p>POUR : FOR - PARA - PARA - FÜR - PER - VOOR  NEUF : NEW - NUEVO - NOVO - NEU - NUOVO - NIEUW  E.S. ECHANGE STANDARD : STANDARD EXCHANGE - CAMBIO ESTANDARD - R.RENOVADO - AUSTAUSCH - REVISIONATO - FABRIEKSRUIL  REFRI : AIR CONDITIONING - AIRE ACONDICIONARD - SEM CLIMATIZAÇÃO - EINFACHE KLIMA - REFRIGERAZIONE - AIRCO</p>						

# CITROËN XANTIA

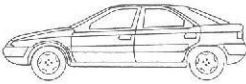
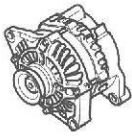
	Fournisseur Supplier Proveedor Fornecedor Lieferant Fornitore Leverancier	Repère Identification mark Marca Referencia Bauteilmarkierung Riferimento Merkteken	Classe Class Clase Classe Klasse Klasse	Ampère Ampere Amperios Ampère Ampere Ampere		
					Neuf	E.S.
<b>Essence - Petrol - Gazolina - Gasolina - Benzin - Benzina - Benzine</b>						
(XU5JP-XU7JP- XU10J2-XU10J4) <b>1,6 L - 1,8 L - 2 L - 2 L 16S</b> Sauf Réfri  <i>Pour Peugeot 406</i>	Valeo " " Mitsubishi "	A13VI 81 A13VI 189 A13VI 280 A 002T 37691 A 002T A0291	8	80A	5705 E6 RP 5705 E7 (90A)	5705 M9
(XU5JP-XU7JP) <b>1,6 L - 1,8 L</b> (XU10J2-XU10J4) <b>2 L - 2 L 16S Réfri</b>  <i>Pour Peugeot 405-406</i>	Valeo " " Mitsubishi "	A13VI 71 A13VI 191 A13VI 281 A 003T A0591 A 004T 02891	9	90A	5705 E7	5705 N7
(XU5JP-XU7JP- XU10J2-XU10J4) <b>1,6 L - 1,8 L - 2 L - 2 L 16S</b> Réfri  <i>Pour Peugeot 406</i>	Mitsubishi "	A 004T 03491 A 004T A0091	12	120A	5705 E8	5705 7K
(XU7JB - XU7JP4) <b>1,8 L - 1,8 L 16S</b> Sauf Réfri  <i>Pour Peugeot 406</i>	Bosch	0 123 310 013	7	70A	5705 S2	5705 W4
	Valeo " " Mitsubishi Bosch	A13VI 102 A13VI 262 A13VI 232 A 002T A1991 0 123 310 011	8	80A	5705 S3 RP 5705 S4 (90A)	5705 W7
(XU7JB - XU7JP4) <b>1,8 L - 1,8 L 16S</b>  <i>Pour Peugeot 406</i>	Valeo " " Mitsubishi	A13VI 101 A13VI 263 A13VI 233 A 002T A2091	9	90A	5705 S4	5705 X0
(XU7JB - XU7JP4) <b>1,8 L - 1,8 L 16S</b> Réfri  <i>Pour Peugeot 406</i>	Valeo	A14VI 14	12	120A	5705 S5	5705 1T
	Valeo	A14VI 15	15	150A	5705 Y3	-
<p><b>POUR</b> : FOR - PARA - PARA - FÜR - PER - VOOR  <b>NEUF</b> : NEW - NUEVO - NOVO - NEU - NUOVO - NIEUW  <b>E.S. ECHANGE STANDARD</b> : STANDARD EXCHANGE - CAMBIO ESTANDARD - R.RENOVADO - AUSTAUSCH - REVISIONATO - FABRIEKSRUIL  <b>SAUF REFRI</b> : EXCEPT AIR CONDITIONING - SALVO AIRE ACONDICIONARD - SEM CLIMATIZAÇÃO - AUSSER EINFACHE KLIMA - SALVO REFRIGERAZIONE - BEHALVE AIRCO  <b>REFRI</b> : AIR CONDITIONING - AIRE ACONDICIONARD - SEM CLIMATIZAÇÃO - EINFACHE KLIMA - REFRIGERAZIONE - AIRCO</p>						

# CITROËN XANTIA

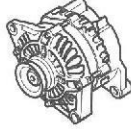
	Fournisseur Supplier Provedor Fornecedor Lieferant Fornitore Leverancier	Repère Identification mark Marca Referencia Bauteilmarkierung Riferimento Merkteken	Classe Class Clase Classe Klasse Klasse Klasse	Ampère Ampere Amperios Ampère Ampere Ampere		
					Neuf	E.S.
<b>Essence - Petrol - Gazolina - Gasolina - Benzin - Benzina - Benzine</b>						
(XU10J2-XU10J4) <b>2 L - 2 L 16S</b> Sauf Réfri  <i>Pour Peugeot 405-406</i>	Valeo " " Mitsubishi "	A13VI 71 A13VI 191 A13VI 281 A 003T A0591 A 004T 02891	9	90A	<b>5705 E7</b>	<b>5705 N7</b>
(XU10J2TE - XU10J4R) <b>2 L Turbo - 2 L 16S</b>  <i>Pour Peugeot 405-406</i>	Bosch	0 123 310 013	7	70A	<b>5705 S2</b>	<b>5705 W4</b>
	Valeo " " Mitsubishi Bosch	A13VI 102 A13VI 232 A13VI 262 A 002T A1991 0 123 310 011	8	80A	<b>5705 S3</b> <b>RP 5705 S4</b> (90A)	<b>5705 W7</b>
	Valeo " " Mitsubishi	A13VI 101 A13VI 233 A13VI 263 A 002T A02091	9	90A	<b>5705 S4</b>	<b>5705 X0</b>
	Valeo	A14VI 14	12	120A	<b>5705 S5</b>	<b>5705 1T</b>
	Valeo	A14VI 15	15	150A	<b>5705 Y3</b>	-
(ES9J4) <b>V6 3 L</b>  <i>Pour Peugeot 406</i>	Valeo " " "	A14VI 18 A14VI 24 A13VI 201 SG12S 019	12	120A	<b>5705 1F</b> <b>RP 5705 6A</b>	<b>5705 5E</b>
	Valeo "	A14VI 17 A14VI 25	15	150A	<b>5705 1G</b>	<b>5705 5G</b>

POUR : FOR - PARA - PARA - FÜR - PER - VOOR

NEUF : NEW - NUEVO - NOVO - NEU - NUOVO - NIEUW

E.S. ECHANGE STANDARD : STANDARD EXCHANGE - CAMBIO ESTANDARD - R.RENOVADO - AUSTAUSCH - REVISIONATO - FABRIEKSUIJL

SAUF REFRI : EXCEPT AIR CONDITIONING - SALVO AIRE ACONDICIONARD - SEM CLIMATIZAÇÃO - AUSSER EINFACHE KLIMA - SALVO REFRIGERAZIONE - BEHALVE AIRCO

REFRI : AIR CONDITIONING - AIRE ACONDICIONARD - SEM CLIMATIZAÇÃO - EINFACHE KLIMA - REFRIGERAZIONE - AIRCO

# CITROËN XANTIA

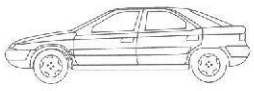
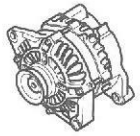
	Fournisseur Supplier Proveedor Fornecedor Lieferant Fornitore Leverancier	Repère Identification mark Marca Referencia Bauteilmarkierung Riferimento Merkteken	Classe Class Clase Classe Klasse Classe Klasse	Ampère Ampere Amperios Ampère Ampere Ampere		
					Neuf	E.S.
<b>Diesel - Gasoleo</b>						
(XUD) 1,9 L - 2,1 L → 06/95 Sauf Refri (Fix. 3 points)  <i>Pour Peugeot 405</i>	Valeo	A11VI 16 A11VI 24 A11VI 47 A11VI 50	5	50A	<b>5705 F3</b> (cl. 7 - 70A)	95 667 740
	Valeo " " Bosch	A11VI 17 A11VI 25 A11VI 40 A11VI 51 0 120 335 012	7	70A		5705 Y1
	Valeo "	A13VI 49 A13VI 87	8	80A	<b>5705 F4</b>	5705 Y2
	(XUD) 1,9 L - 2,1 L → 12/97 Refri (Fix. 3 points) <i>Pour Peugeot 405</i>	Valeo "	A13VI 31 A13VI 85	8	80A	<b>5705 E3</b>
(XUD) 1,9 L - 2,1 L 06/95 → (Fix. 4 points)  <i>Pour Peugeot 405</i>	Valeo " Mitsubishi	A13VI 94 A13VI 231 A13VI 261 A 002T A2094	9	90A	<b>5705 L7</b>	5705 R7
	Valeo Mitsubishi	A14VI 13 A 003 TA 5591	12	120A	<b>5705 K7</b>	5705 1Q
	Valeo	A14VI 16	15	150A	<b>5705 Y4</b>	-
(DW10ATE) 2 L Turbo Sauf Refri <i>Pour Peugeot 406</i>	Valeo " Mitsubishi "	A13VI 204 SG10B 021 A 002 TB 2291 A 002 TB 4891	9	90A	<b>5705 2C</b>	5705 4X
(DW10ATE) 2 L Turbo <i>Pour Peugeot 406</i>	Valeo Mitsubishi "	SG12S 55 A 003 TA 6491 A 003 TB 0891	12	120A	<b>5705 2D</b>	5705 4Z
(DW10ATE) 2 L Turbo  <i>Pour Peugeot 406</i>	Valeo " " " Bosch Mitsubishi	A14VI 27 A14VI 42 SG15S 016 SG15S 021 0 124 615 002 A 004 TF 0091	15	150A	<b>5705 4F</b>	5705 5J

POUR : FOR - PARA - PARA - FÜR - PER - VOOR

FIX 3 POINTS : 3-PIN CONNECTIONS - FIJACIONES 3 PUNTOS - FIXAÇÃO 3 PONTOS - 3-PUNKT BEFESTIGUNG - FISSAGGIO 3 PUNTI - 3 PUNTS BEVESTIGINGEN

FIX 4 POINTS : 4-PIN CONNECTIONS - FIJACIONES 4 PUNTOS - FIXAÇÃO 4 PONTOS - 4-PUNKT BEFESTIGUNG - FISSAGGIO 4 PUNTI - 4 PUNTS BEVESTIGINGEN

NEUF : NEW - NUEVO - NOVO - NEU - NUOVO - NIEUW

E.S. ECHANGE STANDARD : STANDARD EXCHANGE - CAMBIO ESTANDARD - R.RENOVADO - AUSTAUSCH - REVISIONATO - FABRIEKSRUIL

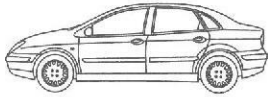
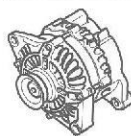

					<b>CITROËN C5</b>	
	Fournisseur Supplier Proveedor Fornecedor Lieferant Fornitore Leverancier	Repère Identification mark Marca Referencia Bauteilmarkierung Riferimento Merkteken	Classe Class Clase Classe Klasse Klasse	Ampère Ampere Amperios Ampère Ampere Ampere		
					Neuf	E.S.
<b>Essence - Petrol - Gazolina - Gazolina - Benzin - Benzina - Benzine</b>						
(EW7J4 - EW10D) <b>1,8L 16S - 2L</b> (EW10J4) <b>2L 16S</b>  <i>Pour Peugeot 306</i>	Valeo " Mitsubishi "	A13VI 203 SG8B 020 A 002 TB 2191 A 002 TB 4791	8	80A	<i>5705 2B</i> <b>RP 5705 2C</b> (90A)	<b>5705 4V</b>
	Valeo "	A13VI 277 SG10B 022	9	90A	<b>5705 5V</b>	<b>5705 7F</b>
	Valeo " Mitsubishi	SG12S 051 SG12S 077 A 003 TB 2691	12	120A	<b>5705 6N</b>	-
(ES9J4S) <b>3L V6</b>  <i>Pour Peugeot 406</i>	Valeo	SG12S 019	12	120A	<b>5705 6A</b>	<b>5705 7P</b>
	Valeo "	A14VI 17 A14VI 25	15	150A	<b>5705 1G</b> → 03/2002	<b>5705 5G</b> → 03/2002
	Valeo	TG15C 015	15	150A	<b>5705 AJ</b> 03/2002 →	-
<b>Diesel - Gasoleo</b>						
(DW10) <b>2L Turbo</b> Sauf Réfri  <i>Pour Peugeot 406</i>	Valeo " Mitsubishi "	A13VI 204 SG10B 021 A 002 TB 2291 A 002 TB 4891	9	90A	<b>5705 2C</b>	<b>5705 4X</b>
(DW10) <b>2L Turbo</b>  <i>Pour Peugeot 406</i>	Valeo Mitsubishi "	SG12S 055 A 003 TA 6491 A 003 TB 0891	12	120A	<b>5705 2D</b>	<b>5705 4Z</b>
(DW10) <b>2L Turbo</b> Réfri  <i>Pour Peugeot 406</i>	Valeo " " " Bosch Mitsubishi	A14VI 27 A14VI 42 SG15S 016 SG15S 021 0 124 615 002 A 004 TF 0091	15	150A	<b>5705 4F</b>	<b>5705 5J</b>
	Valeo " "	A14VI 35 A14VI 41 SG15S 018 SG15S 022 0 124 615 027	15	150A	<i>5705 4S</i> <b>RP 5705 AA</b>	<b>5702 A1</b>
(DW12TED4) <b>2,2L 16S Turbo</b>  <i>Pour Peugeot 406</i>	Valeo " " Bosch	A14VI 35 A14VI 41 SG15S 018 SG15S 022 0 124 615 027	15	150A	<b>5705 AA</b>	<b>5702 A1</b>
<p><b>POUR</b> : FOR - PARA - PARA - FÜR - PER - VOOR  <b>NEUF</b> : NEW - NUEVO - NOVO - NEU - NUOVO - NIEUW  <b>E.S. ECHANGE STANDARD</b> : STANDARD EXCHANGE - R.RENOVADO - AUSTAUSCH - REVISIONATO - FABRIEKSRUIL  <b>SAUF REFRI</b> : EXCEPT AIR CONDITIONING - SALVO AIRE ACONDICIONARD - SEM CLIMATIZAÇÃO - AUSSER EINFACHE KLIMA - SALVO REFRIGERAZIONE - BEHALVE AIRCO  <b>REFRI</b> : AIR CONDITIONING - AIRE ACONDICIONARD - SEM CLIMATIZAÇÃO - EINFACHE KLIMA - REFRIGERAZIONE - AIRCO</p>						

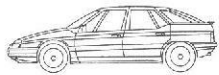
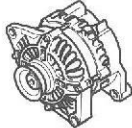
<b>CITROËN XM</b> → 95						
	Fournisseur Supplier Proveedor Fornecedor Lieferant Fornitore Leverancier	Repère Identification mark Marca Referencia Bauteilmarkierung Riferimento Merkteken	Classe Class Clase Classe Klasse Klasse	Ampère Ampere Amperios Ampère Ampere Ampere		
					Neuf	E.S.
Essence - Petrol - Gazolina - Gasolina - Benzin - Benzina - Benzine						
(XU10) 2 L  <i>Pour Peugeot 605</i>	Valeo " " " Mitsubishi	A11VI 32 A11VI 52 A13N 184 A13N 217 A 002T 17491	7	70A	5705 A2	95 656 486
(XU10-ZPJ-ZPJ4) 2 L - V6 3 L  <i>Pour Peugeot 605</i>	Valeo " " " Mitsubishi "	A14N 139 A14N 172 A13VI 68 A13VI 108 A 002T 37692 A 002T 13391	8	80A	5705 G4 RP 5705 G5 (90A)	95 658 579
	Mitsubishi " " "	A 004T 00891 A 004T 02892 A 004T 03292 A 004T A0592	9	90A	5705 G5	95 667 750
	Mitsubishi " " "	A 004T 00991 A 004T 03492 A 004T A0092 A 004T 03392	12	120A	5705 G6	95 667 751
(XU10) 2 L Sauf Réfri	Mitsubishi	A 004T 03793	12	120A	5705 K3 Mont. Multiplexe	-

POUR : FOR - PARA - PARA - FÜR - PER - VOOR  
NEUF : NEW - NUEVO - NOVO - NEU - NUOVO - NIEUW  
E.S. ECHANGE STANDARD : STANDARD EXCHANGE - CAMBIO ESTANDARD - R.RENOVADO - AUSTAUSCH - REVISIONATO - FABRIEKSRUIL  
SAUF REFRI : EXCEPT AIR CONDITIONING - SALVO AIRE ACONDICIONARD - SEM CLIMATIZAÇÃO - AUSSER EINFACHE KLIMA - SALVO REFRIGERAZIONE - BEHALVE AIRCO

# CITROËN XM

→ 95

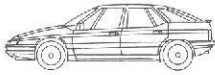

Fournisseur  
Supplier  
Proveedor  
Fornecedor  
Lieferant  
Fornitore  
Leverancier

Repère  
Identification mark  
Marca  
Referencia  
Bauteilmarkierung  
Riferimento  
Merkteken

Classe  
Class  
Clase  
Classe  
Klasse  
Classe  
Klasse

Ampère  
Ampere  
Amperios  
Ampère  
Ampere  
Ampere

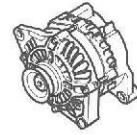

Neuf

E.S.

## Diesel - Gasoleo

(XUD) 2,1 L  <i>Pour Peugeot 605</i>	Valeo " " " " "	A11VI 15 A11VI 18 A11VI 23 A11VI 48 A11VI 49 A11VI 57 Bosch 0 123 110 004	7	70A	5705 E4	5705 N6
	Valeo " " " Mitsubishi "	A14N 139 A14N 172 A13VI 68 A13VI 108 A 002T 37692 A 002T 13391	8	80A	5705 G4 RP 5705 G5 (90A)	95 658 579
	Valeo "	A13VI 80 A13VI 109	8	80A	5705 G9	5705 J2
	Mitsubishi " " "	A 004T 00891 A 004T 02892 A 004T 03292 A 004T A0592	9	90A	5705 G5	95 667 750
	Mitsubishi " "	A 003T A0593 A 004T 03293 A 004T 02893	9	90A	5705 H1	5705 J4
	Mitsubishi	A 004T 03793	12	120A	5705 K3	-

POUR : FOR - PARA - PARA - FÜR - PER - VOOR

NEUF : NEW - NUEVO - NOVO - NEU - NUOVO - NIEUW

E.S. ECHANGE STANDARD : STANDARD EXCHANGE - CAMBIO ESTANDARD - R.RENOVADO - AUSTAUSCH - REVISIONATO - FABRIEKSRUIL

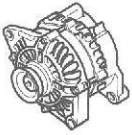

<b>CITROËN XM</b> <b>95 →</b>							
	Fournisseur Supplier Proveedor Fornecedor Lieferant Fornitore Leverancier	Repère Identification mark Marca Referencia Bauteilmarkierung Riferimento Merkteken	Classe Class Clase Classe Klasse Klasse	Ampère Ampere Amperios Ampère Ampere Ampere			
					Neuf	E.S.	
<b>Essence - Petrol - Gazolina - Gasolina - Benzin - Benzina - Benzine</b>							
(XU10J2) 2 L (XU10J2TE) 2 L Turbo → 05/95  <i>Pour Peugeot 605</i>	Valeo " " " Mitsubishi "	A13VI 68 A13VI 108 A14N 172 A14N 139 A 002T 13391 A 002T 37692	8	80A	5705 G4 RP 5705 G5 (90A)	95 658 579	
	Mitsubishi " " "	A 004T 00891 A 004T 02892 A 004T 03292 A 004T A0592	9	90A	5705 G5	95 667 750	
	Mitsubishi " " "	A 004T A0092 A 004T 00991 A 004T 03392 A 004T 03492	12	120A	5705 G6	95 667 751	
	Bosch	0 123 310 013	7	70A	5705 S2	5705 W4	
	Valeo " " Mitsubishi Bosch	A13VI 102 A13VI 262 A13VI 232 A 002T A1991 0 123 310 011	8	80A	5705 S3 RP 5705 S4 (90A)	5705 W7	
	Valeo " " Mitsubishi	A13VI 101 A13VI 263 A13VI 233 A 002T A02091	9	90A	5705 S4	5705 X0	
	Valeo	A14VI 14	12	120A	5705 S5	5705 1T	
	(XU10J2TE) 2 L Turbo 06/95 → Refri  <i>Pour Peugeot 605</i>	Valeo	A14VI 15	15	150A	5705 Y3	-

**POUR** : FOR - PARA - PARA - FÜR - PER - VOOR  
**NEUF** : NEW - NUEVO - NOVO - NEU - NUOVO - NIEUW  
**E.S. CHANGE STANDARD** : STANDARD EXCHANGE - CAMBIO ESTANDARD - R.RENOVADO - AUSTAUSCH - REVISIONATO - FABRIEKSRUIJ  
**REFRI** : AIR CONDITIONING - AIRE ACONDICIONARD - SEM CLIMATIZAÇÃO - EINFACHE KLIMA - REFRIGERAZIONE - AIRCO

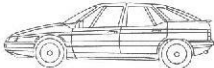
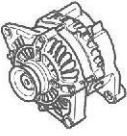

						<b>CITROËN XM</b>	
						<b>95 →</b>	
	Fournisseur Supplier Provedor Fornecedor Lieferant Fornitore Leverancier	Repère Identification mark Marca Referencia Bauteilmarkierung Riferimento Merkteken	Classe Class Clase Classe Klasse Klasse	Ampère Ampere Amperios Ampère Ampere Ampere			
						Neuf	E.S.
<b>Essence - Petrol - Gasolina - Gasolina - Benzin - Benzina - Benzine</b>							
(XU10J4R) 2 L 16S Sauf Réfri → 05/95  <i>Pour Peugeot 605</i>	Valeo " " Mitsubishi "	A13VI 81 A13VI 189 A13VI 280 A 002T 37691 A 002T A0291	8	80A	5705 E6 RP 5705 E7 (90A)	5705 M9	
	Valeo " " Mitsubishi "	A13VI 71 A13VI 191 A13VI 281 A 003T A0591 A 004T 02891	9	90A	5705 E7	5705 N7	
	Mitsubishi "	A 004T 03491 A 004T A0091	12	120A	5705 E8	5705 7K	
(XU10J4R) 2 L 16S Réfri → 05/95  <i>Pour Peugeot 605</i>	Valeo " " Mitsubishi "	A13VI 71 A13VI 191 A13VI 281 A 003T A0591 A 004T 02891	9	90A	5705 E7	5705 N7	
	Mitsubishi "	A 004T 03491 A 004T A0091	12	120A	5705 E8	5705 7K	
(XU10J4R) 2 L 16S 06/95 →  <i>Pour Peugeot 605</i>	Bosch	0 123 310 013	7	70A	5705 S2	5705 W4	
	Valeo " " Mitsubishi Bosch	A13VI 102 A13VI 262 A13VI 232 A 002T A1991 0 123 310 011	8	80A	5705 S3 RP 5705 S4 (90A)	5705 W7	
	Valeo " " Mitsubishi	A13VI 101 A13VI 233 A13VI 263 A 002T A2091	9	90A	5705 S4	5705 X0	
	Valeo	A14VI 14	12	120A	5705 S5	5705 1T	

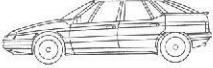
POUR : FOR - PARA - PARA - FÜR - PER - VOOR  
NEUF : NEW - NUEVO - NOVO - NEU - NUOVO - NIEUW  
E.S. ECHANGE STANDARD : STANDARD EXCHANGE - CAMBIO ESTANDARD - R.RENOVADO - AUSTAUSCH - REVISIONATO - FABRIEKSRUIJ  
REFRI : AIR CONDITIONING - AIRE ACONDICIONARD - SEM CLIMATIZAÇÃO - EINFACHE KLIMA - REFRIGERAZIONE - AIRCO  
SAUF REFRI : EXCEPT AIR CONDITIONING - SALVO AIRE ACONDICIONARD - SEM CLIMATIZAÇÃO - AUSSER EINFACHE KLIMA - SALVO REFRIGERAZIONE - BEHALVE AIRCO

<b>CITROËN XM</b> <b>95 →</b>						
	Fournisseur Supplier Proveedor Fornecedor Lieferant Fornitore Leverancier	Repère Identification mark Marca Referencia Bauteilmarkierung Riferimento Merkteken	Classe Class Clase Classe Klasse Klasse	Ampère Ampere Amperios Ampère Ampere Ampere		
					Neuf	E.S.
<b>Essence - Petrol - Gazolina - Gasolina - Benzin - Benzina - Benzine</b>						
(ZPJ-ZPJ4) <b>V6 3 L</b>  <i>Pour Peugeot 605</i>	Valeo " " " Mitsubishi "	A14N 139 A14N 172 A13VI 68 A13VI 108 A 002T 13391 A 002T 37692	8	80A	5705 G4 RP 5705 G5 (90A)	95 658 579
	Mitsubishi " " "	A 004T 00891 A 004T 02892 A 004T 03292 A 004T A0592	9	90A	5705 G5	95 667 750
	Mitsubishi " " "	A 004T A0092 A 004T 00991 A 004T 03392 A 004T 03492	12	120A	5705 G6	95 667 751
(ES9J4) <b>V6 3 L</b>  <i>Pour Peugeot 605</i>	Valeo " " "	A14VI 18 A13VI 201 A14VI 24 SG12S 019	12	120A	5705 1F RP 5705 6A	5705 5E
	Valeo "	A14VI 17 A14VI 25	15	150A	5705 1G	5705 5G

POUR : FOR - PARA - PARA - FÜR - PER - VOOR

NEUF : NEW - NUEVO - NOVO - NEU - NUOVO - NIEUW

E.S. ECHANGE STANDARD : STANDARD EXCHANGE - CAMBIO ESTANDARD - R.RENOVADO - AUSTAUSCH - REVISIONATO - FABRIEKSRIJL

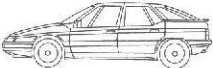
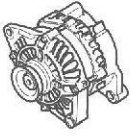
					<b>CITROËN XM</b> <b>95 →</b>	
	Fournisseur Supplier Proveedor Fornecedor Lieferant Fornitore Leverancier	Repère Identification mark Marca Referencia Bauteilmarkierung Riferimento Merkteken	Classe Class Clase Classe Klasse Klasse Klasse	Ampère Ampere Amperios Ampère Ampere Ampere Ampere		
					Neuf	E.S.
<b>Diesel - Gasoleo</b>						
(XUD) 2,1 L → 05/95  <i>Pour Peugeot 605</i>	Valeo "	A13VI 80 A13VI 109	8	80A	5705 G9	5705 J2
	Mitsubishi " "	A 003T A0593 A 004T 02893 A 004T 03293	9	90A	5705 H1	5705 J4
	Mitsubishi	A 004T 03793	12	120A	5705 K3 Mont. Multiplexe	-
(XUD) 2,1 L 06/95 →  <i>Pour Peugeot 605</i>	Valeo " " Mitsubishi	A13VI 231 A13VI 261 A13VI 94 A 002T A2094	9	90A	5705 L7	5705 R7
	Valeo Mitsubishi	A14VI 13 A 003T A5591	12	120A	5705 K7	5705 1Q
(XUD) 2,1 L 01/95 → <b>Réfri</b>  <i>Pour Peugeot 605</i>	Valeo	A14VI 16	15	150A	5705 Y4	-
(DK5ATE) 2,5 L Turbo  <i>Pour Peugeot 605</i>	Valeo	A14VI 10	12	120A	5705 L3	5705 P7

POUR : FOR - PARA - PARA - FÜR - PER - VOOR

NEUF : NEW - NUEVO - NOVO - NEU - NUOVO - NIEUW

E.S. ECHANGE STANDARD : STANDARD EXCHANGE - CAMBIO ESTANDARD - R.RENOVADO - AUSTAUSCH - REVISIONATO - FABRIEKSRUIL

REFRI : AIR CONDITIONING - AIRE ACONDICIONARD - SEM CLIMATIZAÇÃO - EINFACHE KLIMA - REFRIGERAZIONE - AIRCO

# CITROËN EVASION

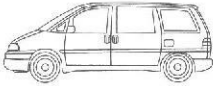
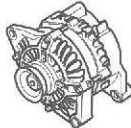
	Fournisseur Supplier Proveedor Fornecedor Lieferant Fornitore Leverancier	Repère Identification mark Marca Referencia Bauteilmarkierung Riferimento Merkteken	Classe Class Clase Classe Klasse Classe Klasse	Ampère Ampere Amperios Ampère Ampere Ampere		
					Neuf	E.S.
<b>Essence - Petrol - Gazolina - Gasolina - Benzin - Benzina - Benzine</b>						
(XU7JP-XU10J2) <b>1,8 L - 2 L</b> (XU10J2TE) <b>2 L Turbo → 01/97</b> Sauf Réfri  <b>Pour Peugeot 806</b>	Valeo " " " " " Bosch Mitsubishi	A11VI 15 A11VI 18 A11VI 48 A11VI 49 A11VI 57 A11VI 23 0 123 110 004 A 002T 17491	7	70A	<b>5705 E4</b>	<b>5705 N6</b>
(XU7JP) <b>1,8 L Sauf Réfri</b>	Valeo " " "	A13VI 48 A13VI 88 A13VI 51 A13VI 86	8	80A	<b>5705 E5</b>	<b>95 667 745</b>
(XU7JP) <b>1,8 L Réfri</b>  <b>Pour Peugeot 806</b>	Valeo " "	A13VI 81 A13VI 189 A13VI 280	8	80A	<b>5705 E6</b> <b>RP 5705 E7</b> (90A)	<b>5705 M9</b>
(XU10J2) <b>2 L</b> (XU10J2TE) <b>2 L Turbo → 01/97</b> Sauf Réfri  <b>Pour Peugeot 806</b>	Mitsubishi "	A 002T 37691 A 002T A0291				
(XU7JP) <b>1,8 L Réfri</b>  <b>Pour Peugeot 806</b>	Mitsubishi "	A 004T 03491 A 004T A0091	12	120A	<b>5705 E8</b>	<b>5705 7K</b>
(XU7JP-XU10J2) <b>1,8 L - 2 L</b> (XU10J2TE) <b>2 L Turbo → 01/97</b>  <b>Pour Peugeot 806</b>	Valeo " " Mitsubishi "	A13VI 71 A13VI 191 A13VI 281 A 004T 02891 A 003T A0591	9	90A	<b>5705 E7</b>	<b>5705 N7</b>

POUR : FOR - PARA - PARA - FÜR - PER - VOOR

NEUF : NEW - NUEVO - NOVO - NEU - NUOVO - NIEUW

E.S. EXCHANGE STANDARD : STANDARD EXCHANGE - CAMBIO ESTANDARD - R.RENOVADO - AUSTAUSCH - REVISIONATO - FABRIEKSRUIL

SAUF REFRI : EXCEPT AIR CONDITIONING - SALVO AIRE ACONDICIONAD - SEM CLIMATIZAÇÃO - AUSSER EINFACHE KLIMA - SALVO REFRIGERAZIONE - BEHALVE AIRCO

REFRI : AIR CONDITIONING - AIRE ACONDICIONAD - SEM CLIMATIZAÇÃO - EINFACHE KLIMA - REFRIGERAZIONE - AIRCO

# CITROËN EVASION

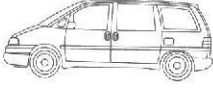
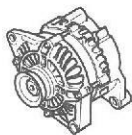
	Fournisseur Supplier Proveedor Fornecedor Lieferant Fornitore Leverancier	Repère Identification mark Marca Referencia Bauteilmarkierung Riferimento Merktiken	Classe Class Clase Classe Klasse Klasse	Ampère Ampere Amperios Ampère Ampere Ampere		
					Neuf	E.S.
<b>Essence - Petrol - Gazolina - Gazolina - Benzin - Benzina - Benzine</b>						
(XU10J2) 2 L (XU10J2TE) 2 L Turbo → 01/97 Refri  <i>Pour Peugeot 806</i>	Valeo	A14VI 10	12	120A	5705 L3	5705 P7
(XU10J4R) 2 L 16S XU10J2TE) 2 L Turbo 02/97→  <i>Pour Peugeot 806</i>	Bosch	0 123 310 013	7	70A	5705 S2	5705 W4
	Valeo " " Mitsubishi Bosch	A13VI 232 A13VI 262 A13VI 102 A 002T A1991 0 123 310 011	8	80A	5705 S3 RP 5705 S4 (90A)	5705 W7
	Valeo " ∇ Mitsubishi	A13VI 233 A13VI 263 A13VI 101 A 002T A2091	9	90A	5705 S4	5705 X0
	Valeo	A14VI 14	12	120A	5705 S5	5705 1T
(EW10J4) 2 L 16S  <i>Pour Peugeot 806</i>	Valeo " Mitsubishi "	A13VI 203 SG8B 020 A 002T B2191 A 002T B4791	8	80A	5705 2B RP 5705 2C (90A)	5705 4V
	Valeo " Mitsubishi "	A13VI 204 SG10B 021 A 002T B2291 A 002T B4891	9	90A	5705 2C	5705 4X
	Valeo Mitsubishi "	SG12S 055 A 003T A6491 A 003T B0891	12	120A	5705 2D	5705 4Z
	Valeo " ∇ ∇ Mitsubishi Bosch	A14VI 27 A14VI 42 SG15S 016 SG15S 021 A 004T F0091 0 124 615 002	15	150A	5705 4F	5705 5J

POUR : FOR - PARA - PARA - FÜR - PER - VOOR  
 NEUF : NEW - NUEVO - NOVO - NEU - NUOVO - NIEUW  
 E.S. ECHANGE STANDARD : STANDARD EXCHANGE - CAMBIO ESTANDARD - R.RENOVADO - AUSTAUSCH - REVISIONATO - FABRIEKSRUIL

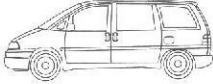
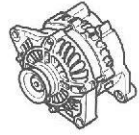

# CITROËN EVASION

	Fournisseur Supplier Proveedor Fornecedor Lieferant Fornitore Leverancier	Repère Identification mark Marca Referencia Bauteilmarkierung Riferimento Merkteken	Classe Class Clase Classe Klasse Klasse	Ampère Ampere Amperios Ampère Ampere Ampere		
					Neuf	E.S.
<b>Diesel - Gasoleo</b>						
(XUD) 1,9 L Atmo 1,9 L Turbo 2,1 L Turbo  <i>Pour Peugeot 806</i>	Valeo " " Mitsubishi Bosch	A13VI 95 A13VI 230 A13VI 260 A 002T A1994 0 123 310 010	8	80A	5705 L6 RP 5705 L7 (90A)	5705 R5
	Valeo " " Mitsubishi	A13VI 94 A13VI 231 A13VI 261 A 002T A2094	9	90A	5705 L7	5705 R7
	Valeo Mitsubishi	A14VI 13 A 003T A5591	12	120A	5705 K7	5705 1Q
(DW10) 2 L Turbo Sauf Refri  <i>Pour Peugeot 806</i>	Valeo " Mitsubishi "	A13VI 204 SG10B 021 A 002T B2291 A 002T B4891	9	90A	5705 2C	5705 4X
(DW10) 2 L Turbo  <i>Pour Peugeot 806</i>	Valeo Mitsubishi "	SG12S 055 A 003T A6491 A 003T B0891	12	120A	5705 2D	5705 4Z
(DW10) 2 L Turbo  <i>Pour Peugeot 806</i>	Valeo " " " Bosch	A14VI 35 A14VI 41 SG15S 018 SG15S 022 0 124 615 027	15	150A	5705 AA	5702 A1
(DW10) 2 L Turbo Refri  <i>Pour Peugeot 806</i>	Valeo " " " Mitsubishi Bosch	A14VI 27 A14VI 42 SG15S 016 SG15S 021 0 124 615 002 A 004T F0091	15	150A	5705 4F	5705 5J

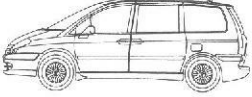
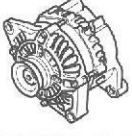

POUR : FOR - PARA - PARA - FÜR - PER - VOOR  
 SAUF REFRI : EXCEPT AIR CONDITIONING - SALVO AIRE ACONDICIONARD - SEM CLIMATIZAÇÃO - AUSSER EINFACHE KLIMA - SALVO REFRIGERAZIONE - BEHALVE AIRCO  
 REFRI : AIR CONDITIONING - AIRE ACONDICIONARD - SEM CLIMATIZAÇÃO - EINFACHE KLIMA - REFRIGERAZIONE - AIRCO  
 NEUF : NEW - NUEVO - NOVO - NEU - NUOVO - NIEUW  
 E.S. ECHANGE STANDARD : STANDARD EXCHANGE - CAMBIO ESTANDARD - R.RENOVADO - AUSTAUSCH - REVISIONATO - FABRIEKSRUIJ

					<b>CITROËN C8</b>	
	Fournisseur Supplier Proveedor Fornecedor Lieferant Fornitore Leverancier	Repère Identification mark Marca Referencia Bauteilmarkierung Riferimento Merkteken	Classe Class Clase Classe Klasse Klasse	Ampère Ampere Amperios Ampère Ampere Ampere		
					Neuf	E.S.
<b>Essence - Petrol - Gazolina - Gasolina - Benzin - Benzina - Benzine</b>						
(EW10J4 - EW12J4) 2 L 16 S - 2,2 L 16 S  <i>Pour Peugeot 807</i>	Valeo "	A13VI 277 SG10B 022	9	90A	5705 5V	-
	Valeo " Mitsubishi	SG12S 051 SG12S 077 A 003 TB 2691	12	120A	5705 6N	-
	Valeo " "	A14VI 40 A14VI 43 SG15S 017	15	150A	5705 6P	-
(ES9J4S) 3 L V6  <i>Pour Peugeot 807</i>	Valeo	SG12S 019	12	120A	5705 6A	-
	Valeo	TG15C 015	15	150A	5705 AJ	-
<b>Diesel - Gasoleo</b>						
(DW10ATED4) 2 L 16 S Turbo  (DW12ATED4) 2,2 L 16 S Turbo  <i>Pour Peugeot 807</i>	Valeo " " " Bosch	A14VI 35 A14VI 41 SG15S 018 SG15S 022 0 124 615 027	15	150A	5705 AA	-

POUR : FOR - PARA - PARA - FÜR - PER - VOOR

NEUF : NEW - NUEVO - NOVO - NEU - NUOVO - NIEUW

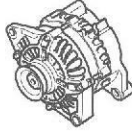
E.S. ECHANGE STANDARD : STANDARD EXCHANGE - CAMBIO ESTANDARD - R.RENOVADO - AUSTAUSCH - REVISIONATO - FABRIEKSPUIJL

<b>CITROËN C15</b>						
	Fournisseur Supplier Provedor Fornecedor Lieferant Fornitore Leverancier	Repère Identification mark Marca Referencia Bauteilmarkierung Riferimento Merkteken	Classe Class Clase Classe Klasse Classe Klasse	Ampère Ampere Amperios Ampère Ampere Ampere		
					Neuf	E.S.
<b>Essence - Petrol - Gazolina - Gasolina - Benzin - Benzina - Benzine</b>						
(XV8-XW7-XY7) 1 L - 1,1 L - 1,4 L → 09/87  <i>Pour Peugeot 104-Samba</i>	Paris-Rhône " Ducellier " Motorola " Bosch	A13N 38 A12R 53 514 005ABCDF 513 004A 9 AR 2728 2 941 097 9 120 144 243	5	50A	5705 11	5705 Y9
(TU9-TU1-TU3) 1 L - 1,1 L - 1,4 L 05/88 → Carter cylindre aluminium  <i>Pour Peugeot 309</i>	Valeo " " Bosch " " Mitsubishi	A13N 129 A13N 175 A13N 215 0 120 489 476 9 120 144 243 0 120 489 467 A 001 T 02674	5	50A	5705 89	5705 Z3
(TU1-TU3) 1,1 L - 1,4 L 03/91 → Carter cylindre fonte  <i>Pour Peugeot 309-405</i>	Valeo Paris-Rhône "	A13N 176 A13N 130 A13N 216	7	70A	5705 90	95 668 060
(E1A-XY7) 1,118 L - 1,294 L  <i>Pour Peugeot 205-309</i>	Valeo Bosch " "	A13N 123 0 120 489 394 0 120 489 393 0 120 144 255	7	70A	5705 63 NFP	-
<p> <b>ÉLECTRIQUE</b> : ELECTRIC - ELECTRICO - ELECTRICO - ELEKTRISCH - ELETRICO - ELECTRISCH  <b>POUR</b> : FOR - PARA - PARA - FÜR - PER - VOOR  <b>NEUF</b> : NEW - NUEVO - NOVO - NEU - NUOVO - NIEUW  <b>E.S. ECHANGE STANDARD</b> : STANDARD EXCHANGE - CAMBIO ESTANDARD - R.RENOVADO - AUSTAUSCH - REVISIONATO - FABRIEKSRIJL  <b>CARTER CYLINDRE ALUMINIUM</b> : CYLINDER BLOCK ALUMINIUM - BLOQUE CILINDRO ALUMINIO - CILINDRO DO CARTER EM ALUMINIO - ZYLINDERBLOCK ALUMINIUM -  CAR TER CILINDRO ALUMINIO - MOTORCARTER ALUMINIUM  <b>CARTER CYLINDRE FONTE</b> : CYLINDER BLOCK CASTIRON - BLOQUE CILINDRO FUNDICION - CILINDRO DO CARTER FUNDID - ZYLINDERBLOCK GUSS - CARTER CILIN  DRO GHISA - MOTORCARTER GIETIJZER</p>						

# CITROËN C15

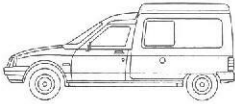

Fournisseur  
Supplier  
Provedor  
Fornecedor  
Lieferant  
Fornitore  
Leverancier

Repère  
Identification mark  
Marca  
Referencia  
Bauteilmarkierung  
Riferimento  
Merkteken

Classe  
Class  
Clase  
Classe  
Klasse  
Klasse

Ampère  
Ampere  
Amperios  
Ampère  
Ampere  
Ampere

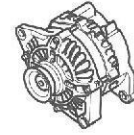



Neuf

E.S.

## Diesel - Gasoleo

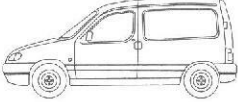
(XUD) 1,8 L  <i>Pour Peugeot 205</i>	Valeo " " Paris-Rhône Mitsubishi " Bosch " " "	A13N 218 A13N 240 A13N 181 A13N 95 A 002T 27091 A 002T 26391 0 120 489 259 0 120 488 215 0 120 489 158 0 120 489 258	5	50A	5705 25	5705 Z0
	Valeo " " " Mitsubishi " " "	A13N 151 A13N 177 A13N 183 A13N 220 A 003T 03291 A 003 T 45191 A 003 T 45291 A 003 T 45292	7	70A	5705 91	5705 Z7
(DW8B) 1,9L  <i>Pour Peugeot 306</i>	Valeo " "	A11VI 91 SG7S 014 SG7S 024	7	70A	5705 2A	5705 4T
	Valeo " Mitsubishi "	A13VI 203 SG8B 020 A 002 TB 2191 A 002 TB 4791	8	80A	5705 2B RP 5705 2C (90A)	5705 4V

<b>CITROËN BERLINGO (I)</b>						
	Fournisseur Supplier Provedor Fornecedor Lieferant Fornitore Leverancier	Repère Identification mark Marca Referencia Bauteilmarkierung Riferimento Merktken	Classe Class Clase Classe Klasse Klasse	Ampère Amperes Amperios Ampère Ampere Ampere		
					Neuf	E.S.
<b>Essence - Petrol - Gazolina - Gasolina - Benzin - Benzina - Benzine</b>						
(TU1M+ -TU3JP) 1,1 L - 1,4 L Sauf Réfri (Sans cic)	Valeo " " Bosch Magneti Marelli "	A11VI 11 A11VI 43 A11VI 55 0 120 335 007 63 321 641 63 321 770	7	70A	5705 E1 (AV10)	5705 X9 (AV10)
	<i>Pour Peugeot PARTNER</i>	Valeo Magneti Marelli	A11VI 89 63 321 671 63 321 771	7	70A	5705 1J (K5)
(TU1M+ -TU3JP) 1,1 L - 1,4 L Sauf Réfri (Avec cic+cp) <i>Pour Peugeot PARTNER</i>	Valeo Magneti Marelli	A11VI 108 66 332 741	7	70A	5705 5X RP 5705 5Z	5705 6T
(TU1M+ -TU3JP) 1,1 L - 1,4 L (Sans cic) <i>Pour Peugeot PARTNER</i>	Valeo " " " Magneti Marelli "	A13VI 46 A13VI 83 A13VI 96 A13VI 240 63 321 723 63 321 772	8	80A	5705 E2 RP 5705 X2 (90A)	5705 Y0
	<i>Pour Peugeot PARTNER</i>	Valeo Denso	A13VI 278 63 321 740	8	80A	5705 5Y RP 5705 6M
(TU1M+ -TU3JP) 1,1 L - 1,4 L (Avec cic+cp) <i>Pour Peugeot PARTNER</i>	Valeo	A13VI 279	9	90A	5705 5Z	5705 6X
(TU1M+ -TU3JP) 1,1 L - 1,4 L Réfri (Sans cic) <i>Pour Peugeot PARTNER</i>	Valeo	A13VI 141	9	90A	5705 X2	5705 1L
(TU5JP4) 1,6 L 16S <i>Pour Peugeot PARTNER</i>	Valeo Magneti Marelli	A13VI 108 63 321 741	7	70A	5705 5X RP 5705 5Z	5705 6T
	Valeo Denso	A13VI 278 63 321 740	8	80A	5705 5Y RP 5705 6M	5705 6V
	Valeo Magneti Marelli	A13VI 279 63 321 741	9	90A	5705 5Z	5705 6X

POUR : FOR - PARA - PARA - FÜR - PER - VOOR  
SANS CIC - SANS CONNECTION INFO CHARGE : WITHOUT LOAD INFORMATION CONNECTION - SIN CONEXION INFO CARGA - SEM CONEÇÃO INFO CARGA - OHNE ANSCHLUSS LADEZUSTANDSANZEIGE - SENZA CONNESSIONE INFO CARICO - ZONDER AANSLUITING OPLAADINFO  
AVEC CIC+CP - AVEC CONNECTION INFO CHARGE + CHARGE PROGRESSIVE: WITH LOAD INFORMATION CONNECTION + VARIABLE OUTPUT - CON CONEXION INFO CARGA + CARGA PROGRESIVA - COM CONEÇÃO INFO CARGA + CARGA PROGRESSIVA - MIT ANSCHLUSS LADEZUSTANDSANZEIGE + PROGRESSIVE LASTANPASSUNG  
CON CONNESSIONE INFO CARICO + CARICO PROGRESSIVO - MET AANSLUITING OPLAADINFO + PROGRESSIEVE LADING  
NEUF : NEW - NUEVO - NOVO - NEU - NUOVO - NIEUW  
E.S. ECHANGE STANDARD : STANDARD EXCHANGE - CAMBIO ESTANDARD - R.RENOVADO - AUSTAUSCH - REVISIONATO - FABRIEKSRUIL  
SAUF REFRI : EXCEPT AIR CONDITIONING - SALVO AIRE ACONDICIONARD - SEM CLIMATIZAÇÃO - AUSSER EINFACHE KLIMA - SALVO REFRIGERAZIONE - BEHALVE AIRCO  
REFRI : AIR CONDITIONING - AIRE ACONDICIONARD - SEM CLIMATIZAÇÃO - EINFACHE KLIMA - REFRIGERAZIONE - AIRCO

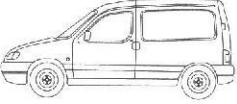
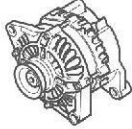

# CITROËN BERLINGO (I)

	Fournisseur Supplier Provedor Fornecedor Lieferant Fornitore Leverancier	Repère Identification mark Marca Referencia Bauteilmarkierung Riferimento Merkteken	Classe Class Clase Classe Klasse Classe Klasse	Ampère Ampere Amperios Ampère Ampere Ampere		
					Neuf	E.S.
<b>Essence - Petrol - Gazolina - Gasolina - Benzin - Benzina - Benzine</b>						
(XU7JB) 1,8 L Sauf Refri  <i>Pour Peugeot PARTNER</i>	Bosch	0 123 310 013	7	70A	5705 S2	5705 W4
	Valeo " "	A13VI 102 A13VI 232 A13VI 262	8	80A	5705 S3 RP 5705 S4 (90A)	5705 W7
	Bosch Mitsubishi	0 123 310 011 A 002T A1991				
(XU7JB) 1,8 L  <i>Pour Peugeot PARTNER</i>	Valeo " "	A13VI 101 A13VI 233 A13VI 263				
(XU7JB) 1,8 L Refri  <i>Pour Peugeot PARTNER</i>	Mitsubishi	A 002T A2091				
	Valeo	A14VI 14	12	120A	5705 S5	5705 1T

POUR : FOR - PARA - PARA - FÜR - PER - VOOR

NEUF : NEW - NUEVO - NOVO - NEU - NUOVO - NIEUW

E.S. ECHANGE STANDARD : STANDARD EXCHANGE - CAMBIO ESTANDARD - R.RENOVADO - AUSTAUSCH - REVISIONATO - FABRIEKSRUIL

SAUF REFRI : EXCEPT AIR CONDITIONING - SALVO AIRE ACONDICIONARD - SEM CLIMATIZAÇÃO - AUSSER EINFACHE KLIMA - SALVO REFRIGERAZIONE - BEHALVE AIRCO

REFRI : AIR CONDITIONING - AIRE ACONDICIONARD - SEM CLIMATIZAÇÃO - EINFACHE KLIMA - REFRIGERAZIONE - AIRCO

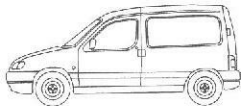
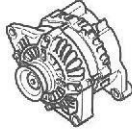
<b>CITROËN BERLINGO (I)</b>						
	Fournisseur Supplier Proveedor Fornecedor Lieferant Fornitore Leverancier	Repère Identification mark Marca Referencia Bauteilmarkierung Riferimento Merkteken	Classe Class Classe Classe Classe Classe	Ampère Ampere Amperios Ampère Ampere Ampere		
					Neuf	E.S.
<b>Diesel - Gasoleo</b>						
(XUD) 1,8 L - 1,9 L Atmo Sauf Réfri Direction non assistée  <i>Pour Peugeot PARTNER</i>	Valeo " " " Bosch	A11VI 25 A11VI 40 A11VI 17 A11VI 51 0 120 335 012	7	70A	5705 F3	5705 Y1
	Valeo "	A13VI 49 A13VI 87	8	80A	5705 F4	5705 Y2
(XUD) 1,8 L - 1,9 L Atmo Réfri  <i>Pour Peugeot PARTNER</i>	Valeo " " Mitsubishi Bosch	A13VI 95 A13VI 230 A13VI 260 A 002T A1994 0 123 310 010	8	80A	5705 L6 RP 5705 L7 (90A)	5705 R5
	Valeo " " Mitsubishi	A13VI 94 A13VI 231 A13VI 261 A 002T A2094	9	90A	5705 L7	5705 R7
(XUD) 1,8 L - 1,9 L Atmo Réfri Direction non assistée  <i>Pour Peugeot PARTNER</i>	Valeo Mitsubishi	A14VI 13 A 003T A5591	12	120A	5705 K7	5705 1Q
(XUD) 1,8 L - 1,9 L Atmo Sauf Réfri Direction assistée  <i>Pour Peugeot PARTNER</i>	Bosch	0 123 310 012	7	70A	5705 L5	5705 X7
	Valeo " " Mitsubishi Bosch	A13VI 95 A13VI 230 A13VI 260 A 002T A1994 0 123 310 010	8	80A	5705 L6 RP 5705 L7 (90)	5705 R5

POUR : FOR - PARA - PARA - FÜR - PER - VOOR

NEUF : NEW - NUEVO - NOVO - NEU - NUOVO - NIEUW

E.S. ECHANGE STANDARD : STANDARD EXCHANGE - CAMBIO ESTANDARD - R.RENOVADO - AUSTAUSCH - REVISIONATO - FABRIEKSRUIL

SAUF REFRI : EXCEPT AIR CONDITIONING - SALVO AIRE ACONDICIONARD - SEM CLIMATIZAÇÃO - AUSSER EINFACHE KLIMA - SALVO REFRIGERAZIONE - BEHALVE AIRCO

REFRI : AIR CONDITIONING - AIRE ACONDICIONARD - SEM CLIMATIZAÇÃO - EINFACHE KLIMA - REFRIGERAZIONE - AIRCO

DIRECTION NON ASSISTEE : WITHOUT POWER STEERING - DIRECCION NO ASSISTIDA - DIRECÇÃO NÃO ASSISTIDA - MECHANISCHE LENKUNG - SENZA SERVOSTERZO -

ZONDER STUURBEKRACHTIGING

DIRECTION ASSISTEE : POWER STEERING SINCE - DIRECCION ASISTIDA - DIRECÇÃO ASSISTIDA - SERVO-LENKUNG - SERVOSTERZO - STUURBEKRACHTIGING

# CITROËN BERLINGO (I)

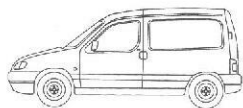

Fournisseur  
Supplier  
Proveedor  
Fornecedor  
Lieferant  
Fornitore  
Leverancier

Repère  
Identification mark  
Marca  
Referencia  
Bauteilmarkierung  
Riferimento  
Merktken

Classe  
Class  
Clase  
Classe  
Klasse  
Classe  
Klasse  
Ampère  
Ampere  
Amperios  
Ampère  
Ampere  
Ampere

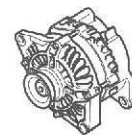

Neuf

E.S.

## Diesel - Gasoleo

(DW8) 1,9L  <i>Pour Peugeot PARTNER</i>	Valeo " "	A11VI 91 SG7S 014 SG7S 024	7	70A	5705 2A	5705 4T
	Valeo " Mitsubishi "	A13VI 203 SG8B 020 A 002T B4791 A002T B2191	8	80A	5705 2B RP 5705 2C (90A)	5705 4V
	Valeo " Mitsubishi "	A13VI 204 SG10B 021 A 002T B2291 A 002T B4891	9	90A	5705 2C	5705 4X
(DW8) 1,9L Réfri  <i>Pour Peugeot PARTNER</i>	Valeo Mitsubishi "	SG12S 055 A 003T A6491 A 003T B0891	12	120	5705 2D	5705 4Z
(DW10TD) 2 L Turbo  <i>Pour Peugeot PARTNER</i>	Valeo " Mitsubishi "	A13VI 204 SG10B 021 A 002T B2291 A 002T B4891	9	90A	5705 2C	5705 4X
	Valeo Mitsubishi "	SG12S 055 A 003T A6491 A 003T B0891	12	120A	5705 2D	5705 4Z
	Valeo " " " Bosch Mitsubishi	A14VI 27 A14VI 42 SG15S 016 SG15S 021 0 124 615 002 A 004T F091	15	150A	5705 4F	5705 5J

POUR : FOR - PARA - PARA - FÜR - PER - VOOR

NEUF : NEW - NUEVO - NOVO - NEU - NUOVO - NIEUW

E.S. ECHANGE STANDARD : STANDARD EXCHANGE - CAMBIO ESTANDARD - AUSTAUSCH - REVISIONATO - FABRIEKSRUIL

SAUF REFRI : EXCEPT AIR CONDITIONING - SALVO AIRE ACONDICIONARD - SEM CLIMATIZAÇÃO - AUSSER EINFACHE KLIMA - SALVO REFRIGERAZIONE - BEHALVE AIRCO

REFRI : AIR CONDITIONING - AIRE ACONDICIONARD - SEM CLIMATIZAÇÃO - EINFACHE KLIMA - REFRIGERAZIONE - AIRCO

**CITROËN BERLINGO (II)**

28/11/2002 →

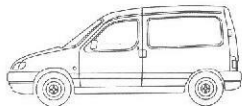

Fournisseur  
Supplier  
Proveedor  
Fornecedor  
Lieferant  
Fornitore  
Leverancier

Repère  
Identification mark  
Marca  
Referencia  
Bauteilmarkierung  
Riferimento  
Merkteken

Classe  
Class  
Clase  
Classe  
Klasse  
Classe  
Klasse

Ampère  
Ampere  
Amperios  
Ampère  
Ampere  
Ampere  
Ampere

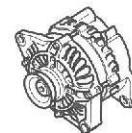

Neuf

E.S.

**Essence - Petrol - Gazolina - Gasolina - Benzin - Benzina - Benzine**

(TU1JP - TU3JP)  
1,1 L - 1,4 L  
(TU5JP4)  
1,6 L 16 S

Valeo  
"  
Mitsubishi  
denso

A11VI 106  
SG7S 015  
A 005T A6291  
633 217 33

7

70A

5705 5T

-

Pour Peugeot  
**PARTNER**

Valeo  
"

A13VI 277  
SG10B 022

9

90A

5705 5V

-

**Diesel - Gasoleo**

(DW8B)  
1,9 L

Valeo  
"  
"

A11VI 91  
SG7S 014  
SG7S 024

7

70A

5705 2A

-

(DW10TD)  
2 L HDi turbo

Valeo  
"  
Mitsubishi  
"

A13VI 203  
SG8B 020  
A 002T B2191  
A 002T B 4791

8

80A

5705 2B  
RP 5705 2C  
(90A)

Pour Peugeot  
**PARTNER**

Valeo  
"  
Mitsubishi  
"

A13VI 204  
SG10B 021  
A 002T B2291  
A 002TB 4891

9

90A

5705 2C

-

(DW10TD)  
2 L HDi Turbo

Valeo  
"  
Bosch

TG15C 022  
TG15C 023  
0 124 525 034

15

150A

5705 AL

-

POUR : FOR - PARA - PARA - FÜR - PER - VOOR

NEUF : NEW - NUEVO - NOVO - NEU - NUOVO - NIEUW

E.S. ECHANGE STANDARD : STANDARD EXCHANGE - CAMBIO ESTANDARD - R.RENOVADO - AUSTAUSCH - REVISIONATO - FABRIEKSRUIL

# CITROËN JUMPY

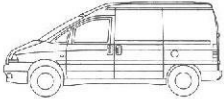
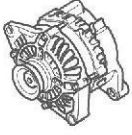
	Fournisseur Supplier Proveedor Fornecedor Lieferant Fornitore Leverancier	Repère Identification mark Marca Referencia Bauteilmarkierung Riferimento Merktken	Classe Class Clase Classe Klasse Classe Klasse	Ampère Ampere Amperios Ampère Ampere Ampere Ampere		
					Neuf	E.S.
<b>Essence - Petrol - Gazolina - Gasolina - Benzin - Benzina - Benzine</b>						
(SPI) <b>1,580 L</b>	Magneti Marelli "	63 321 204 63 321 820	7	70A	<b>5705 R9</b>	<b>5705 7R</b>
<b>Pour Peugeot XPERT</b>	Magneti Marelli	63 321 237	9	90A	<b>5705 S0</b>	<b>5705 7T</b>
(EW10J4) <b>2 L 16S</b>	Valeo " Mitsubishi "	A13VI 204 SG10B 021 A 002T B2291 A 002T B4891	9	90A	<b>5705 2C</b>	<b>5705 4X</b>
<b>Pour Peugeot EXPERT</b>	Valeo Mitsubishi "	SG12S 055 A 003T A6491 A 003T B0891	12	120A	<b>5705 2D</b>	<b>5705 4Z</b>
<b>Diesel - Gasoleo</b>						
(XUD) <b>1,9 L Atmo - Turbo Sauf Réfri Direction non assistée</b>	Valeo " " " Bosch	A11VI 17 A11VI 25 A11VI 40 A11VI 51 0 120 335 012	7	70A	<b>5705 F3</b>	<b>5705 Y1</b>
<b>Pour Peugeot EXPERT</b>	Valeo "	A13VI 49 A13VI 87	8	80A	<b>5705 F4</b>	<b>5705 Y2</b>
(XUD) <b>1,9 L Atmo - Turbo Sauf Réfri Direction assistée Pour Peugeot EXPERT</b>	Bosch	0 123 310 012	7	70A	<b>5705 L5</b>	<b>5705 X7</b>
(XUD) <b>1,9 L Atmo - Turbo Pour Peugeot EXPERT</b>	Valeo " " Mitsubishi Bosch	A13VI 95 A13VI 230 A13VI 260 A 002T A1994 0 123 310 010	8	80A	<b>5705 L6 RP 5705 L7 (90A)</b>	<b>5705 R5</b>
	Valeo " " Mitsubishi	A13VI 94 A13VI 231 A13VI 261 A 002T A2094	9	90A	<b>5705 L7</b>	<b>5705 R7</b>
	Valeo Mitsubishi	A14VI 13 A 003T A5591	12	120A	<b>5705 K7</b>	<b>5705 1Q</b>
<p><b>POUR</b> : FOR - PARA - PARA - FÜR - PER - VOOR  <b>NEUF</b> : NEW - NUEVO - NOVO - NEU - NUOVO - NIEUW  <b>E.S. ECHANGE STANDARD</b> : STANDARD EXCHANGE - CAMBIO ESTANDARD - R.RENOVADO - AUSTAUSCH - REVISIONATO - FABRIEKSRUIL  <b>SAUF REFRI</b> : EXCEPT AIR CONDITIONING - SALVO AIRE ACONDICIONARD - SEM CLIMATIZAÇÃO - AUSSER EINFACHE KLIMA - SALVO REFRIGERAZIONE - BEHALVE AIRCO  <b>DIRECTION NON ASSISTEE</b> : WITHOUT POWER STEERING - DIRECCION NO ASSISTIDA - DIRECÇÃO NÃO ASSISTIDA - MECHANISCHE LENKUNG - SENZA SERVOSTERZO - ZONDER STUURBEKRACHTIGING  <b>DIRECTION ASSISTEE</b> : POWER STEERING SINCE - DIRECCION ASISTIDA - DIRECÇÃO ASSISTIDA - SERVO-LENKUNG - SERVOSTERZO - STUURBEKRACHTIGING</p>						



# CITROËN JUMPY

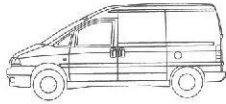

Fournisseur  
Supplier  
Proveedor  
Fornecedor  
Lieferant  
Fornitore  
Leverancier

Repère  
Identification mark  
Marca  
Referencia  
Bauteilmarkierung  
Riferimento  
Merkteken

Classe  
Class  
Clase  
Classe  
Classe  
Classe  
Classe

Ampère  
Ampere  
Amperios  
Ampère  
Ampere  
Ampere  
Ampere

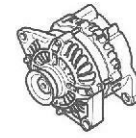

Neuf

E.S.

## Diesel - Gasoleo

(DW8) 1,9L Sauf Réfri <i>Pour Peugeot EXPERT</i>	Valeo " "	A11VI 91 SG7S 014 SG7S 024	7	70A	5705 2A	5705 4T
(DW8) 1,9L <i>Pour Peugeot EXPERT</i>	Valeo " Mitsubishi "	A13VI 203 SG8B 020 A 002T B4791 A002T B2191	8	80A	5705 2B RP 5705 2C (90A)	5705 4V
(DW8) 1,9L Réfri <i>Pour Peugeot EXPERT</i>	Valeo " Mitsubishi "	A13VI 204 SG10B 021 A 002T B2291 A 002T B4891	9	90A	5705 2C	5705 4X
<i>Pour Peugeot EXPERT</i>	Valeo Mitsubishi "	SG12S 055 A 003T A6491 A 003T B0891	12	120	5705 2D	5705 4Z
(DW10) 2 L Turbo <i>Pour Peugeot EXPERT</i>	Valeo " Mitsubishi "	A13VI 204 SG10B 021 A 002T B2291 A 002T B4891	9	90A	5705 2C	5705 4X
(DW10) 2 L Turbo <i>Pour Peugeot EXPERT</i>	Valeo Mitsubishi "	SG12S 055 A 003T A6491 A 003T B0891	12	120A	5705 2D	5705 4Z
(DW10) 2 L Turbo <i>Pour Peugeot EXPERT</i>	Valeo	A14VI 35	15	150A	5705 4S RP 5705 AA	5702 A1
(DW10) 2 L Turbo Refri <i>Pour Peugeot EXPERT</i>	Valeo " " " Bosch Mitsubishi	A14VI 27 A14VI 42 SG15S 016 SG15S 021 0 124 615 002 A 004T F0091	15	150A	5705 4F	5705 5J

POUR : FOR - PARA - PARA - FÜR - PER - VOOR

NEUF : NEW - NUEVO - NOVO - NEU - NUOVO - NIEUW

E.S. ECHANGE STANDARD : STANDARD EXCHANGE - CAMBIO ESTANDARD - R.RENOVADO - AUSTAUSCH - REVISIONATO - FABRIEKSRUIL

SAUF REFRI : EXCEPT AIR CONDITIONING - SALVO AIRE ACONDICIONARD - SEM CLIMATIZAÇÃO - AUSSER EINFACHE KLIMA - SALVO REFRIGERAZIONE - BEHALVE AIRCO

REFRI : AIR CONDITIONING - AIRE ACONDICIONARD - SEM CLIMATIZAÇÃO - EINFACHE KLIMA - REFRIGERAZIONE - AIRCO

**CITROËN JUMPER**

→ 02/2002

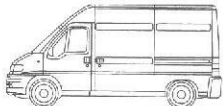
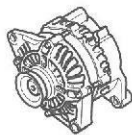
	Fournisseur Supplier Proveedor Fornecedor Lieferant Fornitore Leverancier	Repère Identification mark Marca Referencia Bauteilmarkierung Riferimento Merkteken	Classe Class Clase Classe Klasse Classe Klasse	Ampère Ampere Amperios Ampère Ampere Ampere		
					Neuf	E.S.
<b>Essence - Petrol - Gazolina - Gasolina - Benzin - Benzina - Benzine</b>						
(XU10J2) 2 L Sauf Réfri  <i>Pour Peugeot BOXER</i>	Valeo " " Mitsubishi "	A13VI 81 A13VI 189 A13VI 280 A 002T 37691 A 002T A0291	8	80A	5705 E6 RP 5705 E7 (90A)	5705 M9
(XU10J2) 2 L Réfri  <i>Pour Peugeot BOXER</i>	Valeo " " Mitsubishi "	A13VI 71 A13VI 191 A13VI 281 A 004T 02891 A 003T A0591	9	90A	5705 E7	5705 N7
<b>Diesel - Gasoleo</b>						
(XUD) 1,9 L Atmo  <i>Pour Peugeot BOXER</i>	Valeo "	A13VI 49 A13VI 87	8	80A	5705 F4	5705 Y2
(XUD) 1,9 L Atmo Réfri  <i>Pour Peugeot BOXER</i>	Mitsubishi	A 004T A0094	12	120A	5705 M5	5705 7M
(DW10TD) 2 L Turbo  <i>Pour Peugeot BOXER</i>	Valeo " Mitsubishi "	A13VI 204 SG10B 021 A 002T B2291 A 002T B4891	9	90A	5705 2C	5705 4X
(DW10TD) 2 L Turbo  <i>Pour Peugeot BOXER</i>	Valeo Mitsubishi "	SG12S 055 A 003T A6491 A 003T B0891	12	120A	5705 2D	5705 4Z
(DW10TD) 2 L Turbo  <i>Pour Peugeot BOXER</i>	Valeo " " " Bosch	A14VI 35 A14VI 41 SG15S 018 SG15S 022 0 124 615 027	15	150A	5705 AA	5702 A1

POUR : FOR - PARA - PARA - FÜR - PER - VOOR

NEUF : NEW - NUEVO - NOVO - NEU - NUOVO - NIEUW

E.S. ECHANGE STANDARD : STANDARD EXCHANGE - CAMBIO ESTANDARD - R.RENOVADO - AUSTAUSCH - REVISIONATO - FABRIEKSRUIL

SAUF REFRI : EXCEPT AIR CONDITIONING - SALVO AIRE ACONDICIONARD - SEM CLIMATIZAÇÃO - AUSSER EINFACHE KLIMA - SALVO REFRIGERAZIONE - BEHALVE AIRCO

REFRI : AIR CONDITIONING - AIRE ACONDICIONARD - SEM CLIMATIZAÇÃO - EINFACHE KLIMA - REFRIGERAZIONE - AIRCO

**CITROËN JUMPER**

→ 02/2002

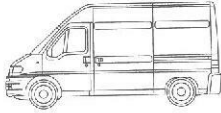

Fournisseur  
Supplier  
Proveedor  
Fornecedor  
Lieferant  
Fornitore  
Leverancier

Repère  
Identification mark  
Marca  
Referencia  
Bauteilmarkierung  
Riferimento  
Merkteken

Classe  
Class  
Clase  
Classe  
Klasse  
Classe  
Klasse

Ampère  
Ampere  
Amperios  
Ampère  
Ampere  
Ampere

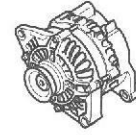

Neuf

E.S.

**Diesel - Gasoleo**

(DJ5-DJ5T-DJ5TED) 2,5 L Atmo 2,5 L Turbo	Valeo	A13VI 71 A13VI 191 A13VI 281	9	90A	5705 E7	5705 N7
	Mitsubishi	A 004T 02891 A 003T A0591				
<i>Pour Peugeot BOXER</i>	Mitsubishi	A 004T 03491 A 004T A0091	12	120A	5705 E8	5705 7K
SOFIM 2,8 L Sauf HDI	Valeo	A13VI 72	8	80A	5705 4C	5705 7X
	Valeo	A13VI 73	11	110A	5705 4E	5705 7Z
	Valeo	A14VI 37	12	120A	5705 6Q	5705 7V
<i>Pour Peugeot BOXER</i>	Valeo	SG12B 040	12	120A	5705 AF	5702 C1
SOFIM 2,8 L HDI	Valeo	SG15S 010	15	150A	5705 AE	5702 A9
<i>Pour Peugeot BOXER</i>	Valeo					

POUR : FOR - PARA - PARA - FÜR - PER - VOOR

NEUF : NEW - NUEVO - NOVO - NEU - NUOVO - NIEUW

E.S. ECHANGE STANDARD : STANDARD EXCHANGE - CAMBIO ESTANDARD - R.RENOVADO - AUSTAUSCH - REVISIONATO - FABRIEKSRUIJ

SAUF REFRI : EXCEPT AIR CONDITIONING - SALVO AIRE ACONDICIONARD - SEM CLIMATIZAÇÃO - AUSSER EINFACHE KLIMA - SALVO REFRIGERAZIONE - BEHALVE AIRCO

REFRI : AIR CONDITIONING - AIRE ACONDICIONARD - SEM CLIMATIZAÇÃO - EINFACHE KLIMA - REFRIGERAZIONE - AIRCO

# CITROËN JUMPER

## 02/2002 →

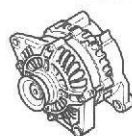
	Fournisseur Supplier Proveedor Fornecedor Lieferant Fornitore Leverancier	Repère Identification mark Marca Referencia Bauteilmarkierung Riferimento Merkteken	Classe Class Clase Classe Klasse Classe Klasse	Ampère Ampere Amperios Ampère Ampere Ampere		
					Neuf	E.S.
<b>Essence - Petrol - Gazolina - Gasolina - Benzin - Benzina - Benzine</b>						
(XU10J2) <b>2 L</b>  <i>Pour Peugeot BOXER</i>	Valeo " " Mitsubishi "	A13VI 81 A13VI 189 A13VI 280 A 002T 37691 A 002T A0291	8	80A	5705 E6 RP 5705 E7 (90A)	5705 M9
<b>Diesel - Gasoleo</b>						
(DW10TD) <b>2 L Turbo</b>	Valeo " Mitsubishi "	A13VI 204 SG10B 021 A 002T B2291 A 002T B4891	9	90A	5705 2C	5705 4X
(DW12TED) <b>2,2 L Turbo</b>  <i>Pour Peugeot BOXER</i>	Valeo " " " Bosch Mitsubishi	A14VI 27 A14VI 42 SG15S 016 SG15S 021 0 124 615 002 A 004T F0091	15	150A	5705 4F	5705 5J
(SOFIM) <b>2,8 L HDi</b>	-	-	9	90A	5705 AK	-
<i>Pour Peugeot BOXER</i>	Valeo	SG12B 040	12	120A	5705 AF	5702 C1

POUR : FOR - PARA - PARA - FÜR - PER - VOOR

NEUF : NEW - NUEVO - NOVO - NEU - NUOVO - NIEUW

E.S. ECHANGE STANDARD : STANDARD EXCHANGE - CAMBIO ESTANDARD - R.RENOVADO - AUSTAUSCH - REVISIONATO - FABRIEKSRUIJ

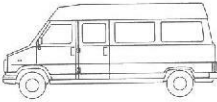
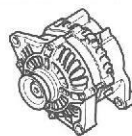
<b>CITROËN C25</b>						
	Fournisseur Supplier Proveedor Fornecedor Lieferant Fornitore Leverancier	Repère Identification mark Marca Referencia Bauteilmarkierung Riferimento Merkteken	Classe Class Clase Klasse Classe Klasse	Ampère Ampere Amperios Ampère Ampere Ampere		
					Neuf	E.S.
<b>Essence - Petrol - Gazolina - Gasolina - Benzin - Benzina - Benzine</b>						
(XM-XN) 1,8 L - 2 L  <i>Pour Peugeot 504-505-J5-J7</i>	Valeo Paris-Rhône Motorola " "	A13N 221 A13N 42 9 AR 2672 9 AR 2673 9 AR 2964	5	50A	5705 04	95 607 228 (Multifonction)
	Valeo Paris-Rhône Motorola " "	A13N 239 A14N 93 9 AR 2672 9 AR 2690 2 940 426	7	70A	5705 H3	5705 Z2 (Monofonction)
<b>Diesel - Gasoleo</b>						
(XUD) 1,9 L Atmo  <i>Pour Peugeot J5</i>	Valeo " Paris-Rhône " Bosch " " Mitsubishi "	A13N 218 A13N 240 A13N 181 A13N 95 0 120 488 215 0 120 489 158 0 120 489 259 A 002T 26391 A 002T 27091	5	50A	5705 25	5705 Z0
	(CRD) 2,5 L Atmo → 07/84  <i>Pour Peugeot J5</i>	Paris-Rhône " " " Ducellier	A13N 247 A14N 1 A14N 2 A14N 55 A14N 91 516 013 ABC	7	70A	5705 K1
(CRD) 2,5 L Atmo → 07/84 2,5 L Turbo  <i>Pour Peugeot J5</i>	Valeo " Paris-Rhône " Motorola	2 940 275 A13N 247 A14N 91 A14N 90 9 AR 5097	7	70A		5705 Y6 (Multifonction)
(M705T) 1,9 L Turbo (XT)  <i>Pour Peugeot J5</i>	Magneti Marelli	63 321 080	5	50A	5705 E9	-
<p>POUR : FOR - PARA - PARA - FÜR - PER - VOOR  NEUF : NEW - NUEVO - NOVO - NEU - NUOVO - NIEUW  E.S. ECHANGE STANDARD : STANDARD EXCHANGE - CAMBIO ESTANDARD - R.RENOVADO - AUSTAUSCH - REVISIONATO - FABRIEKSRIJL  MULTIFUNCTION : MULTIFUNCTION - MULTIFUNCIÓN - MULTIFUNÇÃO - MULTIFUNKTION - MULTIFUNZIONE - MULTIFUNCTIES  MONOFUNCTION : MONOFUNCTION - MONOFUNCIÓN - MONOFUNÇÃO - MONOFUNKTION - MONOFUNZIONE - ENKELFUNCTIE</p>						

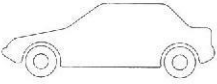
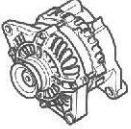

## 2CV-LN-LNA-VISA

	Fournisseur Supplier Proveedor Fornecedor Lieferant Fornitore Leverancier	Repère Identification mark Marca Referencia Bauteilmarkierung Riferimento Merkteken	Classe Class Clase Classe Klasse Klasse	Ampère Ampere Amperios Ampère Ampere Ampere		
					Neuf	E.S.
<b>Essence - Petrol - Gazolina - Gasolina - Benzin - Benzina - Benzine</b>						
<b>2CV 4 - 2CV 6</b>	Ducellier " Femsa Iskra Motorola Paris-Rhône " " "	7532AD 7534AD ALN12-1 AAG 0702 9 AL 2696 A11M 4 A11M 6 A11M 11 A11M 12	5	50A	5 473 145 NFP	5705 Z9
<b>LN LNA-Visa 2 cyl. 06/84 →</b>	Valeo Motorola " Femsa	A11R 3 9 AR 5096 2 940 255 ALD 12N53	5	50A	NFP	95 618 728
<b>LNA-Visa 2 cyl. → 06/84</b>	Ducellier Motorola " " Paris-Rhône " " Femsa " Lucas	512 008 BE 9 AR 5096 9 AR 2662 2 940 255 A12M 11 A12M 17 A12R 43 ALT12N28 ALT12N43 23 987	5	50A	NFP	5705 1A
<b>LNA11 Visa Super-11-L-GT Chrono → 02/84</b>	Paris-Rhône " " " Ducellier "	A12M 16 A12M 9 A12R 45 A13N 38 512 010 ABC 514 013 AB	5	50A	5705 11	5705 Y5
<b>Visa 10-11-14-GT Chrono 02/84 → Pour Peugeot 104- Samba</b>	Paris-Rhône " Motorola " Ducellier Bosch	A12R 53 A13N 38 9 AR 2728 2 941 097 514 005 ABCDE 9 120 144 243	5	50A	5705 11	5705 Y9

POUR : FOR - PARA - PARA - FÜR - PER - VOOR

NEUF : NEW - NUEVO - NOVO - NEU - NUOVO - NIEUW

E.S. EXCHANGE STANDARD : STANDARD EXCHANGE - CAMBIO ESTANDARD - R.RENOVADO - AUSTAUSCH - REVISIONATO - FABRIEKSRUIJL

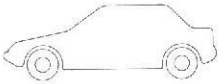
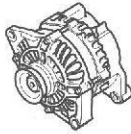
<b>2CV-LN-LNA-VISA</b>						
	Fournisseur Supplier Proveedor Fornecedor Lieferant Fornitore Leverancier	Repère Identification mark Marca Referencia Bauteilmarkierung Riferimento Merkteken	Classe Class Clase Classe Klasse Klasse	Ampère Ampere Amperios Ampère Ampere Ampere	 Neuf E.S.	
<b>Essence - Petrol - Gazolina - Gasolina - Benzin - Benzina - Benzine</b>						
<b>Visa GTI</b> <b>Visa Diesel</b>  <i>Pour Peugeot 205-305-309-405</i>	Valeo " Paris-Rhône " Mitsubishi " Bosch " "	A13N 218 A13N 240 A13N 181 A13N 95 A 002T 26391 A 002T 27091 0 120 488 215 0 120 489 158 0 120 489 259	5	50A	5705 25	5705 Z0
					<b>GS-GSA-AXEL</b>	
<b>Essence - Petrol - Gazolina - Gasolina - Benzin - Benzina - Benzine</b>						
<b>GS-GSA → 07/80</b>	Paris-Rhône " " Ducellier " " Femsa Motorola SEV "	A11M 7 A11R 1 A12M 5 7540 7541 ABC 7562 AF ALG 12-5 9 AL 2762 70 220 302 70 220 702	5	50A	NFP	NFP
<b>GSA-Axel 07/80 →</b>	Ducellier Motorola " Paris-Rhône " Femsa	514 006 AB 9 AR 2748 9 AR 2828 A12R 38 A12R 46 ALP 12-17	5	50A	NFP	5705 1B
POUR : FOR - PARA - PARA - FÜR - PER - VOOR NEUF : NEW - NUEVO - NOVO - NEU - NUOVO - NIEUW E.S. ECHANGE STANDARD : STANDARD EXCHANGE - CAMBIO ESTANDARD - R.RENOVADO - AUSTAUSCH - REVISIONATO - FABRIEKSRUIL						

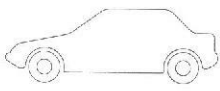
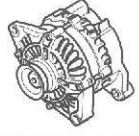
						<b>CX</b>	
	Fournisseur Supplier Proveedor Fornecedor Lieferant Fornitore Leverancier	Repère Identification mark Marca Referencia Bauteilmarkierung Riferimento Merktken	Classe Class Classe Classe Classe Classe	Ampère Ampere Amperios Ampère Ampere Ampere			
					Neuf	E.S.	
<b>Essence - Petrol - Gazolina - Gasolina - Benzin - Benzina - Benzine</b>							
<b>CX 2L - 2,2L - 2,4L GTI Prestige → 07/79</b>	Paris-Rhône " Motorola	A14N 91 A14R 22 9 AL 2628	5	50A	<b>5705 K1</b>	<b>5705 Y7 NFP</b>	
<b>CX 2L - 2,2L - 2,4L GTI Prestige 03/79 →</b>	Paris-Rhône " Motorola SEV	A14N 91 A14R 11 A14R 3 9 AL 2505 71 333 102	5	50A		<b>5705 Y8</b>	
<b>CX 03/79 → Sauf 2 L - 2,2 L</b>	Paris-Rhône " " " Ducellier	A13N 247 A14N 1 A14N 2 A14N 55 A14N 91 516 013 ABC	7	70A		<b>5705 Z5 (Multifonction)</b>	
<b>CX 07/84 → Sauf CX 20-22</b>	Valeo " Paris-Rhône " Motorola	2 940 275 A13N 247 A14N 91 A14N 90 9 AR 5097	7	70A		<b>5705 Y6 (Multifonction)</b>	
<b>CX Reflex-Athéna → 07/82</b>	Paris-Rhône " Motorola Ducellier SEV	A14N 22 A14N 93 2 940 426 516 016 71 770 102	7	70A	<b>5705 H3</b>	<b>5705 Z8 NFP (Multifonction)</b>	
<b>CX 20-22 07/82 →</b>	Valeo Paris-Rhône Motorola " "	A13N 239 A14N 93 9 AR 2672 9 AR 2690 2 940 426	7	70A		<b>5705 Z2 (Monofonction)</b>	
<b>CX 2 L - 2,2 L Pays très chauds</b>	-	-	-	-	<b>95 495 929 NFP</b>	-	
<b>CX 2 L - 2,2 L Réfri</b>	-	-	-	-	<b>95 598 734 NFP</b>	-	

NEUF : NEW - NUEVO - NOVO - NEU - NUOVO - NIEUW

E.S. ECHANGE STANDARD : STANDARD EXCHANGE - CAMBIO ESTANDARD - R.RENOVADO - AUSTAUSCH - REVISIONATO - FABRIEKSRIJL

MULTIFONCTION : MULTIFUNCTION - MULTIFUNCION - MULTIFUNÇÃO - MULTIFUNKTION - MULTIFUNZIONE - MULTIFUNCTIES

MONOFONCTION : MONOFUNCTION - MONOFUNCION - MONOFUNÇÃO - MONOFUNKTION - MONOFUNZIONE - ENKELFUNCTIE

PAYS TRES CHAUDS : VERY HOT COUNTRIES - PAISES MUY CALIDOS - PAISES MUITO QUENTES - SEHR HEISSE LÄNDER - PAESI MOLTO CALDI - ZEER WARMELANDEN

REFRI : AIR CONDITIONING - AIRE ACONDICIONARD - SEM CLIMATIZAÇÃO - EINFACHE KLIMA - REFRIGERAZIONE - AIRCO

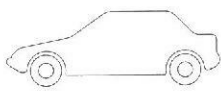
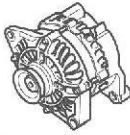
<b>CX</b>						
	Fournisseur Supplier Proveedor Fornecedor Lieferant Fornitore Leverancier	Repère Identification mark Marca Referencia Bauteilmarkierung Riferimento Merkteken	Classe Class Clase Classe Klasse Klasse	Ampère Ampere Amperios Ampère Ampere Ampere		
					Neuf	E.S.
<b>Diesel - Gazolina</b>						
<b>CX → 07/79</b>	Paris-Rhône " Motorola	A14N 91 A14R 22 9 AL 2628	5	50A	<b>5705 K1</b>	<b>5705 Y7 NFP</b>
<b>CX 03/79 →</b>	Paris-Rhône " Motorola SEV	A14N 91 A14R 11 A14R 3 9 AL 2505 71 333 102	5	50A		<b>5705 Y8</b>
<b>CX 03/79 → 07/84</b>	Paris-Rhône " " " " Ducellier	A13N 247 A14N 1 A14N 2 A14N 55 A14N 91 516 013 ABC	7	70A		<b>5705 Z5 (Multifonction)</b>
<b>CX 07/84 →</b>	Valeo " Paris-Rhône " Motorola	2 940 275 A13N 247 A14N 91 A14N 90 9 AR 5097	7	70A		<b>5705 Y6 (Multifonction)</b>
					<b>C35</b>	
<b>Essence - Petrol - Gazolina - Gazolina - Benzin - Benzina - Benzine - Diesel</b>						
<b>Tous Types</b>	Valeo "	A13N 92 A13N 109	7	70A	<b>95 598 735 NFP</b>	<b>5705 1E</b>
<p>NEUF : NEW - NUEVO - NOVO - NEU - NUOVO - NIEUW  E.S. ECHANGE STANDARD : STANDARD EXCHANGE - CAMBIO ESTANDARD - R.RENOVADO - AUSTAUSCH - REVISIONATO - FABRIEKSRUIL  MULTIFONCTION : MULTIFUNCTION - MULTIFUNCION - MULTIFUNÇÃO - MULTIFUNKTION - MULTIFUNZIONE - MULTIFUNCTIES  TOUS TYPES : ALL TYPES - TODOS LOS TIPOS - TODOS TIPOS - ALLE TYPEN - TUTTI I TIPI - ALLE TYPEN</p>						

**DEMARREURS  
STARTERS  
ARRANCADORES  
MOTORES DE ARRANQUE  
ANLASSER  
MOTORINI DI AVVIAMENTO  
STARTERS**

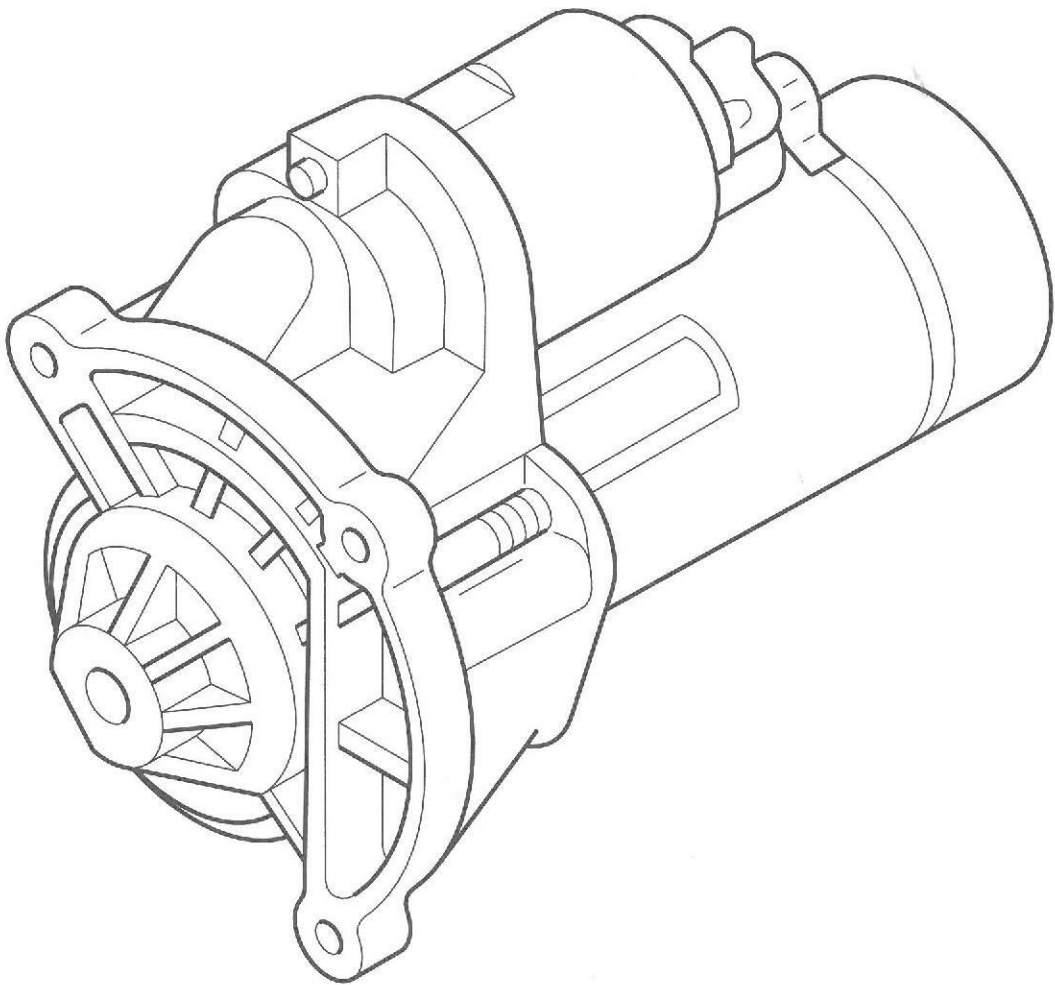



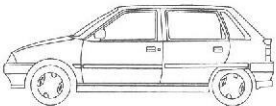
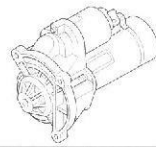

# CITROËN AX

	Fournisseur Supplier Proveedor Fornecedor Lieferant Fornitore Leverancier	Repère Identification mark Marca Referencia Bauteilmarkierung Riferimento Merkteken	Classe Class Clase Classe Klasse Classe Klasse	KW		
					Neuf	E.S.
<b>Diesel - Gasoleo</b>						
(TUD3 - TUD5) 1,4 L - 1,5 L  <i>Pour Peugeot 106</i>	Valeo	D7 R1				
	"	D7 R3				
	"	D7 R11				
	"	D6 RA100				
	Bosch	0 001 108 074	4	1,4	<b>5802 E9</b>	<b>5802 Q3</b>
"	0 001 108 112					
"	0 001 108 125					
"	0 001 108 162					
(TUD5) 1,5 L  <i>Pour Peugeot 106</i>	Valeo	D7 R15				
"	D7 R151	5	1,7	<b>5802 G2</b>	<b>5802 M0</b>	

POUR : FOR - PARA - PARA - FÜR - PER - VOOR

KW : PUISSANCE : POWER - POTENCIA - LEISTUNG - POTENZA - VERMOGEN

NEUF : NEW - NUEVO - NOVO - NEU - NUOVO - NIEUW

E.S. ECHANGE STANDARD : STANDARD EXCHANGE - CAMBIO ESTANDARD - R.RENOVADO - AUSTAUSCH - REVISIONATO - FABRIEKSRUIL

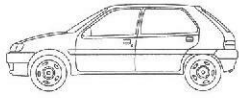
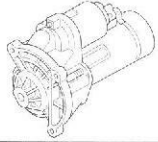
<b>CITROËN SAXO</b>						
	Fournisseur Supplier Provedor Fornecedor Lieferant Fornitore Leverancier	Repère Identification mark Marca Referencia Bauteilmarkierung Riferimento Merkteken	Classe Class Clase Classe Klasse Classe Klasse	KW		
					Neuf	E.S.
<b>Essence - Petrol - Gazolina - Gasolina - Benzin - Benzina - Benzine</b>						
(TU9M-TU1M+-TU3JP-TU5JP-TU5J4) 1 L - 1,1 L - 1,4 L - 1,6 L - 1,6 L 16S  <i>Pour Peugeot 106</i>	Valeo " " Bosch Mitsubishi	D7 E7 D7 E16 D7 E71 0 001 116 003 M 002 T 13081	1		5802 Q7 RP 5802 M9	5802 Q9
	Valeo " " Ducellier Bosch " " Iskra "	D7 E2 D7 E5 D7 E23 534 054 0 001 112 007 0 001 112 019 0 001 112 029 0 001 112 041 AZE 1521 AZE 1523	2	0,9	5802 M9	5802 P8
	Valeo " " "	D6 RA37 D6 RA57 D6 RA571 D6 RA572	3	1,1	5802 C9	5802 N3
<b>Diesel - Gasoleo</b>						
(TUD5) 1,5 L  <i>Pour Peugeot 106</i>	Valeo " " " Bosch " " "	D7 R1 D7 R3 D7 R11 D6 RA 100 0 001 108 074 0 001 108 112 0 001 108 125 0 001 108 162	4	1,4	5802 E9	5802 Q3
	Valeo "	D7 R15 D7 R151	5	1,7	5802 G2	5802 M0
<p>POUR : FOR - PARA - PARA - FÜR - PER - VOOR  KW : PUISSANCE : POWER - POTENCIA - LEISTUNG - POTENZA - VERMOGEN  NEUF : NEW - NUEVO - NOVO - NEU - NUOVO - NIEUW  E.S. ECHANGE STANDARD : STANDARD EXCHANGE - CAMBIO ESTANDARD - R.RENOVADO - AUSTAUSCH - REVISIONATO - FABRIEKSUIJL</p>						

# CITROËN C3

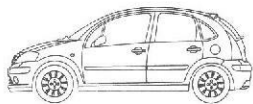

Fournisseur  
Supplier  
Proveedor  
Fornecedor  
Lieferant  
Fornitore  
Leverancier

Repère  
Identification mark  
Marca  
Referencia  
Bauteilmarkierung  
Riferimento  
Merktelen

Classe  
Class  
Clase  
Classe  
Klasse  
Classe  
Klasse

KW

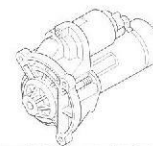

Neuf

E.S.

## Essence - Petrol - Gazolina - Gasolina - Benzin - Benzina - Benzine

(TU1JP-TU3JP) 1,1 L - 1,4 L	Valeo	D7 E7	1		5802 Q7 RP 5802 M9	5802 Q9
	"	D7 E16				
	"	D7 E71				
(TU5JP4) 1,6 L 16 S	Bosch	0 001 116 003	2	0,9	5802 M9	5802 P8
	Mitsubishi	M 002 T 13081				
	Valeo	D7 E2				
	"	D7 E5				
	"	D7 E23				
	Ducellier	534 054				
Bosch	0 001 112 007	3	1,1	5802 C9	5802 N3	
"	0 001 112 019					
"	0 001 112 029					
"	0 001 112 041					
Iskra	AZE 1521					
"	AZE 1523					

## Diesel - Gasoleo

(DV4TD) 1,4 L Turbo	Valeo	D6 RA110	4	1,4	5802 Y4	-
(DV4TED4) 1,4 L 16 S Turbo	Valeo	D7G3	5	1,7	5802 Z8	-

KW : PUISSANCE : POWER - POTENCIA - LEISTUNG - POTENZA - VERMOGEN

NEUF : NEW - NUEVO - NOVO - NEU - NUOVO - NIEUW

E.S. ECHANGE STANDARD : STANDARD EXCHANGE - CAMBIO ESTANDARD - R.RENOVADO - AUSTAUSCH - REVISIONATO - FABRIEKSRUIL

# CITROËN ZX

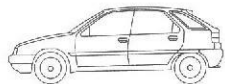

Fournisseur  
Supplier  
Proveedor  
Fornecedor  
Lieferant  
Fornitore  
Leverancier

Repère  
Identification mark  
Marca  
Referencia  
Bauteilmarkierung  
Riferimento  
Merktelen

Classe  
Class  
Clase  
Classe  
Classe  
Classe

KW

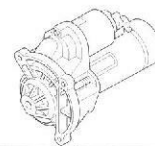

Neuf

E.S.

**Essence - Petrol - Gazolina - Gasolina - Benzin - Benzina - Benzine**

(TU1-TU3) 1 L - 1,4 L  <i>Pour Peugeot 306</i>	Valeo " " "	D6 RA37 D6 RA57 D6 RA571 D6 RA 572	3	1,1	5802 C9	5802 N3
(XU5-XU7-XU9-XU10) 1,6 L - 1,8 L - 1,9 L - 2L  <i>Pour Peugeot 306</i>	Valeo " " " Bosch "	D6 RA16 D6 RA38 D6 RA66 D6 RA661 0 001 107 019 0 001 107 063	3	1,1	5802 E4	5802 Q2
	Valeo "	D6 RA511 D6 RA51	3	1,1	5802 E7	95 667 755
	Bosch "	0 001 108 085 0 001 108 176	4	1,4	5802 E5	5802 H4
	Bosch	0 001 108 128	4	1,4	5802 E6	5802 H3

POUR : FOR - PARA - PARA - FÜR - PER - VOOR

KW : PUISSANCE : POWER - POTENCIA - LEISTUNG - POTENZA - VERMOGEN

NEUF : NEW - NUEVO - NOVO - NEU - NUOVO - NIEUW

E.S. ECHANGE STANDARD : STANDARD EXCHANGE - CAMBIO ESTANDARD - R.RENOVADO - AUSTAUSCH - REVISIONATO - FABRIEKSRUIL





# CITROËN XSARA

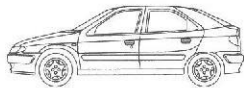

Fournisseur  
Supplier  
Proveedor  
Fornecedor  
Lieferant  
Fornitore  
Leverancier

Repère  
Identification mark  
Marca  
Referencia  
Bauteilmarkierung  
Riferimento  
Merkteken

Classe  
Class  
Clase  
Classe  
Klasse  
Classe  
Klasse

KW

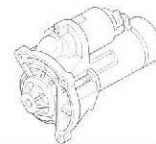

Neuf

E.S.

## Essence - Petrol - Gazolina - Gasolina - Benzin - Benzina - Benzine

(TU3JP – TU5JP – TU5JP4)  1,4L – 1,6L – 1,6L 16S  <i>Pour Peugeot 306</i>	Valeo " " Bosch Mitsubishi	D7 E7 D7 E16 D7 E71 0 001 116 003 M 002 T 13081	1		5802 Q7 RP 5802 M9	5802 Q9
	Valeo " " Ducellier Bosch " " " Iskra "	D7 E2 D7 E5 D7 E23 534 054 0 001 112 007 0 001 112 019 0 001 112 029 0 001 112 041 AZE 1521 AZE 1523	2	0,9	5802 M9	5802 P8
	Valeo " " "	D6 RA37 D6 RA57 D6 RA571 D6 RA572	3	1,1	5802 C9	5802 N3
(XU7JP – XU7JB - XU7JP4 ) 1,8L – 1,8L 16S  (XU10J4R – XU10J4RS) 2L 16S  <i>Pour Peugeot 306</i>	Valeo " " " Bosch "	D6 RA38 D6 RA16 D6 RA661 D6 RA66 0 001 107 019 0 001 107 063	3	1,1	5802 E4	5802 Q2
	Bosch "	0 001 108 085 0 001 108 176	4	1,4	5802 E5	5802 H4
(EW10J4) 2L 16S  <i>Pour Peugeot 307</i>	Valeo Mitsubishi	D6 RA74 M 000 T 82081	3	1,1	5802 V7	5802 W3
	Mitsubishi	M 000 T 85381	4	1,4	5802 V8	5802 W4

POUR : FOR - PARA - PARA - FÜR - PER - VOOR

KW : PUISSANCE : POWER - POTENCIA - LEISTUNG - POTENZA - VERMOGEN

NEUF : NEW - NUEVO - NOVO - NEU - NUOVO - NIEUW

E.S. ECHANGE STANDARD : STANDARD EXCHANGE - CAMBIO ESTANDARD - R.RENOVADO - AUSTAUSCH - REVISIONATO - FABRIEKSRUIL

# CITROËN XSARA

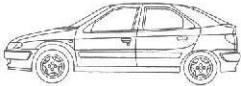
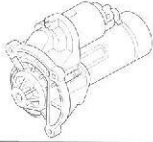
	Fournisseur Supplier Proveedor Fornecedor Lieferant Fornitore Fornitore Leverancier	Repère Identification mark Marca Referencia Bauteilmarkierung Riferimento Merkteken	Classe Class Clase Classe Klasse Klasse	KW		
					Neuf	E.S.
<b>Diesel - Gasoleo</b>						
(DV4TD) <b>1,4 L Turbo</b> <i>Pour Peugeot 206</i>	Valeo	D6 RA110	4	1,4	<b>5802 Y4</b>	-
(TUD5) <b>1,5 L</b> <i>Pour Peugeot 106</i>	Valeo " " " Bosch " " "	D7 R1 D7 R3 D7R11 D6 R100 0 001 108 125 0 001 108 074 0 001 108 112 0 001 108 162	4	1,4	<b>5802 E9</b>	<b>5802 Q3</b>
	Valeo "	D7 R15 D7R151	5	1,7	<b>5802 G2</b>	<b>5802 M0</b>
(XUD7 - XUD9 - DW8) <b>1,8 L - 1,9 L</b>  (DW10) <b>2 L Turbo</b>  <i>Pour Peugeot 306-607</i>	Valeo " " " Mitsubishi "	D7 R2 D7 R4 D7 R8 D7 R26 M 001 T 80082 M 001 T 80481	5	1,7	<b>5802 M3</b>	<b>5802 V5</b>
	Valeo "	D7 R12 D7 R27	6	2	<b>5802 M4</b>	<b>5802 V6</b>
(DW8 - DW10) <b>1,9L Atmo - 2L Turbo</b> <i>Pour Peugeot 206</i>	Valeo Bosch Mitsubishi	D6 RA109 0 001 108 183 M 001 T 80381	4	1,4	<b>5802 W5</b>	<b>5802 W9</b>
(DW8 - DW10) <b>1,9L Atmo - 2L Turbo</b> 06/2002 →	Valeo	D8 R27	6	2	<b>5802 Z5</b>	-

POUR : FOR - PARA - PARA - FÜR - PER - VOOR

KW : PUISSANCE : POWER - POTENCIA - POTENCIA- LEISTUNG - POTENZA - VERMOGEN

NEUF : NEW - NUEVO - NOVO - NEU - NUOVO - NIEUW

E.S. ECHANGE STANDARD : STANDARD EXCHANGE - CAMBIO ESTANDARD - R.RENOVADO - AUSTAUSCH - REVISIONATO - FABRIEKSRIJL

# CITROËN XSARA PICASSO

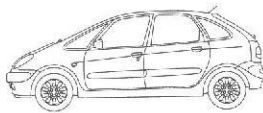
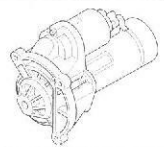
	Fournisseur Supplier Proveedor Fornecedor Lieferant Fornitore Leverancier	Repère Identification mark Marca Referencia Bauteilmarkierung Riferimento Merkteken	Classe Class Clase Classe Klasse Klasse	KW		
					Neuf	E.S.
<b>Essence - Petrol - Gazolina - Gasolina - Benzin - Benzina - Benzine</b>						
(TU5JP) 1,6 L  <i>Pour Peugeot 306</i>	Valeo " " Bosch Mitsubishi	D7 E7 D7 E16 D7 E71 0 001 116 003 M 002 T 13081	1		5802 Q7 RP 5802 M9	5802 Q9
	Valeo " " Ducellier Bosch " " " Iskra "	D7 E2 D7 E5 D7 E23 534 054 0 001 112 007 0 001 112 019 0 001 112 029 0 001 112 041 AZE 1521 AZE 1523	2	0,9	5802 M9	5802 P8
	Valeo " " "	D6 RA37 D6 RA57 D6 RA571 D6 RA572	3	1,1	5802 C9	5802 N3
(EW7J4 - EW10J4) 1,8 L 16S - 2 L 16 S  <i>Pour Peugeot 307</i>	Valeo Mitsubishi	D6 RA74 M 000 T 82081	3	1,1	5802 V7	5802 W3
	Mitsubishi	M 000 T 85381	4	1,4	5802 V8	5802 W4
<b>Diesel - Gasoleo</b>						
(DW10TD) 2 L Turbo 01/2001 →  <i>Pour Peugeot 307</i>	Valeo Bosch Mitsubishi	D6 RA109 0 001 108 183 M 001 T 80381	4	1,4	5802 W5	5802 W9
(DW10TD) 2 L Turbo  <i>Pour Peugeot 306-607</i>	Valeo " " " Mitsubishi "	D7 R2 D7 R4 D7 R8 D7 R26 M 001 T 80082 M 001 T 80481	5	1,7	5802 M3	5802 V5
	Valeo "	D7 R12 D7 R27	6	2	5802 M4	5802 V6
<p><b>POUR</b> : FOR - PARA - PARA - FÜR - PER - VOOR  <b>KW</b> : PUISSANCE : POWER - POTENCIA - POTENCIA - LEISTUNG - POTENZA - VERMOGEN  <b>NEUF</b> : NEW - NUEVO - NOVO - NEU - NUOVO - NIEUW  <b>E.S.</b> : ECHANGE STANDARD : STANDARD EXCHANGE - CAMBIO ESTANDARD - R.RENOVADO - AUSTAUSCH - REVISIONATO - FABRIEKSRUIL</p>						

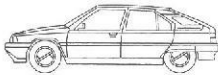
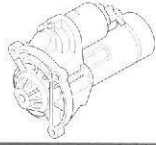
						<b>CITROËN BX</b>	
	Fournisseur Supplier Proveedor Fornecedor Lieferant Fornitore Leverancier	Repère Identification mark Marca Referencia Bauteilmarkierung Riferimento Merkteken	Classe Class Clase Classe Klasse Klasse	KW			
					Neuf	E.S.	
<b>Essence - Petrol - Gazolina - Gasolina - Benzin - Benzina - Benzine</b>							
(XY7- XW7-TU3) <b>1,1 L - 1,4 L</b> 07/83 → 05/88  <i>Pour Peugeot 104- 205-Samba</i>	Paris-Rhône " " " Ducellier " " Bosch " " "	D8 E117 D8 E151 D9 E64 D9 E75 6220 AC 532 014 AB 534 048 9 000 142 002 0 001 208 226 0 001 208 228 0 001 208 518		3	1,1	<b>5802 45</b>	<b>5802 P4</b>
(TU1-TU3) <b>1,1 L - 1,4 L 05/88 →</b>  <i>Pour Peugeot 205- 305-405</i>	Valeo " " Ducellier Bosch " " " Iskra "	D7 E2 D7 E5 D7 E23 534 054 0 001 112 007 0 001 112 019 0 001 112 029 0 001 112 041 AZE 1521 AZE 1523		2	0,9	<b>5802 M9</b>	<b>5802 P8</b>
(XU5-XU9) <b>1,6 L - 1,9 L</b>  <i>Pour Peugeot 405</i>	Valeo " Paris-Rhône " Ducellier Bosch " Iskra	D6 RA8 D6 RA18 D9 E49 D9 E48 534 039 0 001 208 516 0 001 208 707 AZF 3528		3	1,1	<b>5802 E4</b>	<b>5802 P3</b>

POUR : FOR - PARA - PARA - FÜR - PER - VOOR

KW : PUISSANCE : POWER - POTENCIA - POTENCIA - LEISTUNG - POTENZA - VERMOGEN

NEUF : NEW - NUEVO - NOVO - NEU - NUOVO - NIEUW

E.S. ECHANGE STANDARD : STANDARD EXCHANGE - CAMBIO ESTANDARD - R.RENOVADO - AUSTAUSCH - REVISIONATO - FABRIEKSRIJL

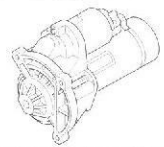

<b>CITROËN BX</b>						
	Fournisseur Supplier Provedor Fornecedor Lieferant Fornitore Leverancier	Repère Identification mark Marca Referencia Bauteilmarkierung Riferimento Merkteken	Classe Class Classe Classe Classe Classe	KW		
					Neuf	E.S.
<b>Essence - Petrol - Gazolina - Gasolina - Benzin - Benzina - Benzine</b>						
(XY5-XU9) <b>1,6 L - 1,9 L Export Réfri Pays froids (S) ( N) (SF)</b>	Valeo " Paris-Rhône " Ducellier Bosch " Iskra	D6 RA8 D6 RA18 D9 E49 D9 E48 534 039 0 001 208 516 0 001 208 707 AZF 3528	3	1,1	91 507 478 RP 5802 E4	5802 P3
(XU5-XU9) <b>1,6 L - 1,9 L Export Réfri Pays froids (S) ( N) (SF)</b>  <i>Pour Peugeot 405</i>	Valeo " Mitsubishi " " " Bosch " "	D9 R84 D9 R121 M 001T 90281 M 001T 80081 M 001T 50171 M 001T 50172 0 001 110 017 0 001 314 034 0 001 109 026	5	1,7	5802 C3 RP 5802 M3	5802 H8
<b>Diesel Gasoleo</b>						
(XUD7-XUD9) <b>1,8 L - 1,9 L</b>  <i>Pour Peugeot 405</i>	Valeo " Mitsubishi " " Bosch "	D7 R84 D9 R121 M 001T 90281 M 001T 80081 M 001T 50172 0 001 110 017 0 001 314 034	5	1,7	5802 M3	5802 H8
(XUD9) <b>1,9 L Export BVA Réfri Pays froids (S) ( N) (SF)</b>  <i>Pour Peugeot 405</i>	Valeo "	D7R 12 D7R 27	6	2	5802 A2 RP 5802 M4	5802 V6
<p>POUR : FOR - PARA - PARA - FÜR - PER - VOOR  KW : PUISSANCE : POWER - POTENCIA - POTENCIA - LEISTUNG - POTENZA - VERMOGEN  NEUF : NEW - NUEVO - NOVO - NEU - NUOVO - NIEUW  E.S. ECHANGE STANDARD : STANDARD EXCHANGE - CAMBIO ESTANDARD - R.RENOVADO - AUSTAUSCH - REVISIONATO - FABRIEKSRIJL  SAUF REFRI : EXCEPT AIR CONDITIONING - SALVO AIRE ACONDICIONARD - SEM CLIMATIZAÇÃO - AUSSER EINFACHE KLIMA - SALVO REFRIGERAZIONE - BEHALVE AIRCO  SAUF PAYS FROIDS : EXCEPT COLD COUNTRIES - SALVO PAISES FRIOS - SALVO PAISES FRIOS - AUSSER KALTE LANDER - SALVO PAESI FREDDI -  BEHALVE KOUDE LANDEN</p>						

# CITROËN XANTIA

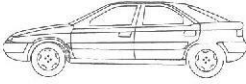
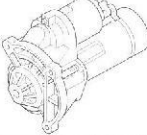
	Fournisseur Supplier Proveedor Fornecedor Lieferant Fornitore Leverancier	Repère Identification mark Marca Referencia Bauteilmarkierung Riferimento Merkteken	Classe Class Clase Classe Klasse Klasse	KW		
					Neuf	E.S.
<b>Essence - Petrol - Gazolina - Gasolina - Benzin - Benzina - Benzine</b>						
(XU5JP-XU7JP-XU7JB XU7JP4-XU10J2- XU10J2TE-XU10J4R) <b>1,6 L - 1,8 L - 1,8 L 16S - 2 L - 2 L Turbo - 2 L 16S</b>	Valeo	D6 RA16	3	1,1	<b>5802 E4</b>	<b>5802 Q2</b>
	"	D6 RA66				
	"	D6 RA38				
	"	D6 RA661				
	Bosch	0 001 107 019				
	"	0 001 107 063				
<b>Pour Peugeot 405- 406-806 Partner</b>	Bosch	0 001 108 085	4	1,4	<b>5802 E5</b>	<b>5802 H4</b>
	"	0001 108 176				
(XU10J4) <b>2 L 16S</b> <b>Pour Peugeot 306- 405</b>	Valeo	D6 RA511	3	1,1	<b>5802 E7</b>	<b>95 667 755</b>
	"	D6 RA51				
	Bosch	0 001 108 128	4	1,4	<b>5802 E6</b>	<b>5802 H3</b>
(ES9J4) <b>3 L V6</b> <b>Pour Peugeot 406- 605</b>	Valeo	D7 R17	4	1,4	<b>5802 N4</b>	<b>5802 W0</b>

POUR : FOR - PARA - PARA - FÜR - PER - VOOR

KW : PUISSANCE : POWER - POTENCIA - POTENCIA - LEISTUNG - POTENZA - VERMOGEN

NEUF : NEW - NUEVO - NOVO - NEU - NUOVO - NIEUW

E.S. ECHANGE STANDARD : STANDARD EXCHANGE - CAMBIO ESTANDARD - R.RENOVADO - AUSTAUSCH - REVISIONATO - FABRIEKSPUIJL

# CITROËN XANTIA

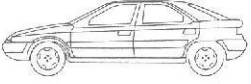
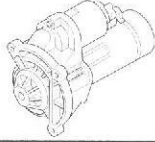
	Fournisseur Supplier Proveedor Fornecedor Lieferant Fornitore Leverancier	Repère Identification mark Marca Referencia Bauteilmarkierung Riferimento Merkteken	Classe Class Clase Classe Classe Klasse	KW		
					Neuf	E.S.
<b>Diesel - Gasoleo</b>						
(XUD9-XUD11) 1,9 L - 2,1 L → 12/97  <i>Pour Peugeot 405-406</i>	Paris Rhône	D9 R84	5	1,7	5802 M3	5802 H8
	"	D9 R121				
Mitsubishi	M 001T 90281					
"	M 001T 50171					
"	M 001T 50172					
Bosch	0 001 110 017					
"	0 001 314 034					
"	0 001 109 026					
	Valeo	D7 R12	6	2	5802 C4	5802 H7
	"	D9 R122			RP 5802 M4	
(XUD9-DW10-XUD11) 1,9 L - 2 L - 2,1 L 12/97 →  <i>Pour Peugeot 405-406</i>	Valeo	D7 R2	5	1,7	5802 M3	5802 V5
	"	D7 R4				
"	D7 R8					
"	D7 R26					
Mitsubishi	M 001T 80082					
"	M 001T 80081					
	Valeo	D7 R12	6	2	5802 M4	5802 V6
	"	D7 R27				

POUR : FOR - PARA - PARA - FÜR - PER - VOOR

KW : PUISSANCE : POWER - POTENCIA - LEISTUNG - POTENZA - VERMOGEN

NEUF : NEW - NUEVO - NOVO - NEU - NUOVO - NIEUW

E.S. ECHANGE STANDARD : STANDARD EXCHANGE - CAMBIO ESTANDARD - R.RENOVADO - AUSTAUSCH - REVISIONATO - FABRIEKSRUIL

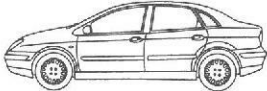
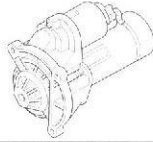
						<b>CITROËN C5</b>	
	Fournisseur Supplier Proveedor Fornecedor Lieferant Fornitore Leverancier	Repère Identification mark Marca Referencia Bauteilmarkierung Riferimento Merktken	Classe Class Clase Classe Klasse Klasse	KW			
					Neuf	E.S.	
<b>Essence - Petrol - Gazolina - Gasolina - Benzin - Benzina - Benzine</b>							
(EW7J4 - EW10D) <b>1,8 L 16S - 2L</b> (EW10J4) <b>2 L 16S</b>  <i>Pour Peugeot 607</i>	Valeo Mitsubishi	D6 RA74 M 000 T 82081	3	1,1	<b>5802 V7</b>	<b>5802 W3</b>	
	Mitsubishi	M 000 T 85381	4	1,4	<b>5802 V8</b>	<b>5802 W4</b>	
(ES9J4S) <b>3L V6</b>  <i>Pour Peugeot 406-607</i>	Valeo	D6 RA107	4	1,4	<b>5802 W6</b>	<b>5802 X8</b>	
<b>Diesel - Gasoleo</b>							
(DW10) <b>2 L Turbo</b>  (DW12TED4) <b>2,2 L 16S Turbo</b>  <i>Pour Peugeot 406-607</i>	Valeo " " " Mitsubishi "	D7 R2 D7 R4 D7 R8 D7 R26 M 001T 80082 M 001T 80481	5	1,7	<b>5802 M3</b>	<b>5802 V5</b>	
	Valeo "	D7 R12 D7 R27	6	2	<b>5802 M4</b>	<b>5802 V6</b>	
	Bosch	0 001 223 014	6	2	<b>5802 W7</b>	<b>5802 Y0</b>	
<p>POUR : FOR - PARA - PARA - FÜR - PER - VOOR  KW : PUISSANCE - POWER - POTENCIA - POTENCIA - LEISTUNG - POTENZA - VERMOGEN  NEUF : NEW - NUEVO - NOVO - NEU - NUOVO - NIEUW  E.S. ECHANGE STANDARD : STANDARD EXCHANGE - CAMBIO ESTANDARD - R.RENOVADO - AUSTAUSCH - REVISIONATO - FABRIEKSRUIL</p>							

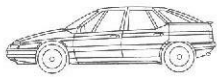
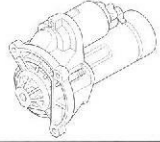
<b>CITROËN XM</b>						
	Fournisseur Supplier Proveedor Fornecedor Lieferant Fornitore Leverancier	Repère Identification mark Marca Referencia Bauteilmarkierung Riferimento Merktken	Classe Class Classe Classe Klasse Klasse	KW		
					Neuf	E.S.
<b>Essence - Petrol - Gazolina - Gasolina - Benzin - Benzina - Benzine</b>						
(XU10-XU10J2TE) <b>2 L - 2 L Turbo</b> <i>Pour Peugeot 605</i>	Valeo " " " Bosch "	D6 RA16 D6 RA661 D6 RA66 D6 RA38 0 001 107 019 0 001 107 063	3	1,1	<b>5802 E4</b>	<b>5802 Q2</b>
(XU10J2TE) <b>2 L Turbo</b> <i>Pour Peugeot 605</i>	Bosch "	0 001 108 085 0 001 108 176	4	1,4	<b>5802 E5</b>	<b>5802 H4</b>
(ZPJ-ZPJ4) <b>V6 3 L</b> <i>Pour Peugeot 605</i>	Valeo " "	D6 RA721 D6 RA12 D6 RA72	3	1,1	<b>5802 A8</b>	<b>5802 Q0</b>
	Bosch "	0 001 108 086 0 001 108 138	4	1,4	<b>5802 A9</b>	-
(ES9J4) <b>V6 3 L</b> <i>Pour Peugeot 605</i>	Valeo	D7 R17	4	1,4	<b>5802 N4</b>	<b>5802 W0</b>

POUR : FOR - PARA - PARA - FÜR - PER - VOOR

KW : PUISSANCE : POWER - POTENCIA - POTENCIA- LEISTUNG - POTENZA - VERMOGEN

NEUF : NEW - NUEVO - NOVO - NEU - NUOVO - NIEUW

E.S. ECHANGE STANDARD : STANDARD EXCHANGE - CAMBIO ESTANDARD - R.RENOVADO - AUSTAUSCH - REVISIONATO - FABRIEKSRUIL

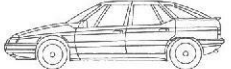
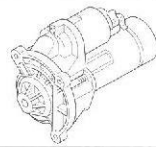

					<b>CITROËN XM</b>	
	Fournisseur Supplier Proveedor Fornecedor Lieferant Fornitore Leverancier	Repère Identification mark Marca Referencia Bauteilmarkierung Riferimento Merktken	Classe Class Clase Classe Klasse Classe Klasse	KW		
					Neuf	E.S.
<b>Diesel - Gasoleo</b>						
(XUD) 2,1 L Atmo - Turbo  <i>Pour Peugeot 605</i>	Valeo Paris Rhône Mitsubishi " " Bosch " "	D9 R121 D9 R84 M 001T 90281 M 001T 80081 M 001T 50172 M 001T 50171 0 001 110 017 0 001 314 034 0 001 109 026	5	1,7	5802 C3 RP 5802 M3	5802 H8
	Valeo "	D7 R12 D9 R122	6	2	5802 C4 RP 5802 M4	5802 H7
(DK5ATE) 2,5 L Turbo  <i>Pour Peugeot 605</i>	Mitsubishi " Bosch	M 002T 80582 M 002T 84771 0 001 218 157	6	2	5802 G4	5802 L8

POUR : FOR - PARA - PARA - FÜR - PER - VOOR

KW : PUISSANCE : POWER - POTENCIA - POTENCIA - LEISTUNG - POTENZA - VERMOGEN

NEUF : NEW - NUEVO - NOVO - NEU - NUOVO - NIEUW

E.S. ECHANGE STANDARD : STANDARD EXCHANGE - CAMBIO ESTANDARD - R.RENOVADO - AUSTAUSCH - REVISIONATO - FABRIEKSRUIL

# CITROËN EVASION

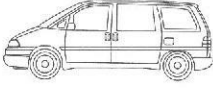
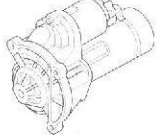
	Fournisseur Supplier Proveedor Fornecedor Lieferant Fornitore Leverancier	Repère Identification mark Marca Referencia Bauteilmarkierung Riferimento Merkteken	Classe Class Clase Classe Klasse Klasse	KW		
					Neuf	E.S.
<b>Essence - Petrol - Gazolina - Gasolina - Benzin - Benzina - Benzine</b>						
(XU7JP-XU10J2) (XU10J4R - XU10J2TE) <b>1,8 L - 2 L</b> <b>2 L 16S - 2 L Turbo</b>	Valeo " " " Bosch "	D6 RA16 D6 RA661 D6 RA66 D6 RA38 0 001 107 019 0 001 107 063	3	1,1	<b>5802 E4</b>	<b>5802 Q2</b>
	Bosch "	0 001 108 085 0 001 108 176	4	1,4	<b>5802 E5</b>	<b>5802 H4</b>
	Valeo " Mitsubishi " " " Bosch " "	D9 R121 D9 R84 M 001T 80081 M 001T 90281 M 001T 50171 M 001T 50172 0 001 110 017 0 001 314 034 0 001 109 026	5	1,7	<b>5802 C3</b> <b>RP 5802 M3</b>	<b>5802 H8</b>
<b>Pour Peugeot 806</b>						
(EW10J4) <b>2L 16S</b>	Valeo Mitsubishi	D6 RA74 M 000T 82081	3	1,1	<b>5802 V7</b>	<b>5802 W3</b>
	Mitsubishi	M 000T 85381	4	1,4	<b>5802 V8</b>	<b>5802 W4</b>
<b>Diesel - Gasoleo</b>						
(XUD9TE-XUD11BTE) <b>1,9 L Turbo</b> <b>2,1 L Turbo</b>	Valeo " " " Mitsubishi "	D7 R26 D7 R4 D7 R2 D7 R8 M 001T 80082 M 001T 80481	5	1,7	<b>5802 M3</b>	<b>5802 V5</b>
	(DW10) <b>2 L Turbo</b>	Valeo "	D7 R27 D7 R12	6	2	<b>5802 M4</b>
<b>Pour Peugeot 806</b>						
<p>POUR : FOR - PARA - PARA - FÜR - PER - VOOR  KW : PUISSANCE : POWER - POTENCIA - POTENCIA - LEISTUNG - POTENZA - VERMOGEN  NEUF : NEW - NUEVO - NOVO - NEU - NUOVO - NIEUW  E.S. ECHANGE STANDARD : STANDARD EXCHANGE - CAMBIO ESTANDARD - R.RENOVADO - AUSTAUSCH - REVISIONATO - FABRIEKSRIJL</p>						

# CITROËN C8

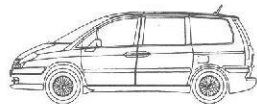

Fournisseur  
Supplier  
Proveedor  
Fornecedor  
Lieferant  
Fornitore  
Leverancier

Repère  
Identification mark  
Marca  
Referencia  
Bauteilmarkierung  
Riferimento  
Merktken

Classe  
Class  
Clase  
Classe  
Klasse  
Klasse  
Klasse

KW

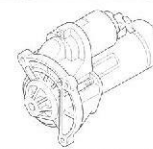

Neuf

E.S.

## Essence - Petrol - Gazolina - Gasolina - Benzin - Benzina - Benzine

(EW10J4 - EW12J4) 2L 16S - 2,2 L 16S	Valeo Mitsubishi	D6 RA74 M 000T 82081	3	1,1	5802 V7	-
<i>Pour Peugeot 807</i>	Mitsubishi	M 000T 85381	4	1,4	5802 V8	-
(ES9J4S) 3L V6 <i>Pour Peugeot 807</i>	Valeo	D6 RA107	4	1,4	5802 W6	-

## Diesel - Gasoleo

(DW10ATED4) 2 L 16 S Turbo	Valeo " " " Mitsubishi	D7 R2 D7 R4 D7 R8 D7 R26 M 001T 80082 M 001T 80481	5	1,7	5802 M3	-
(DW12ATED4) 2,2 L 16 S Turbo <i>Pour Peugeot 807</i>	Bosch	0 001 223 014	6	2	5802 W7	-

POUR : FOR - PARA - PARA - FÜR - PER - VOOR

KW : PUISSANCE : POWER - POTENCIA - POTENCIA - LEISTUNG - POTENZA - VERMOGEN

NEUF : NEW - NUEVO - NOVO - NEU - NUOVO - NIEUW

E.S. ECHANGE STANDARD : STANDARD EXCHANGE - CAMBIO ESTANDARD - R.RENOVADO - AUSTAUSCH - REVISIONATO - FABRIEKSRUIL

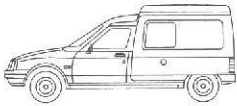
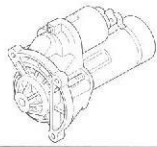
<b>CITROËN C15</b>						
	Fournisseur Supplier Proveedor Fornecedor Lieferant Fornitore Leverancier	Repère Identification mark Marca Referencia Bauteilmarkierung Riferimento Merkteken	Classe Class Clase Classe Klasse Classe Klasse	KW		
					Neuf	E.S.
<b>Essence - Petrol - Gazolina - Gasolina - Benzin - Benzina - Benzine</b>						
(XV8 - XW7 - XY7) 1 L - 1,1 L - 1,4 L → 09/87  <i>Pour Peugeot 104- 205-Samba</i>	Paris-Rhône	D9 E64	3	1,1	5802 45	5802 P4
	"	D9 E75				
	"	D8 E117				
	"	D8 E151				
	Ducellier	6220 AC				
	"	532 014 AB				
"	534 048					
"	Bosch	9 000 142 002				
"	"	0 001 208 226				
"	"	0 001 208 228				
"	"	0 001 208 518				
(TU9 - TU1 - TU3) 1 L - 1,1 L - 1,4 L 05/88 →  <i>Pour Peugeot 205</i>	Valeo	D7 E2	2	0,9	5802 M9	5802 P8
	"	D7 E5				
	"	D7 E23				
	Ducellier	534 054				
	Bosch	0 001 112 007				
	"	0 001 112 019				
	"	0 001 112 029				
	"	0 001 112 041				
	Iskra	AZE 1521				
	"	AZE 1523				
Valeo	D6 RA5	3	1,1	5802 C9	5802 Q1	
	"					D6 RA10
	"					D6 RA20
	Ducellier					534 055
Valeo	D6 RA37	3	1,1	5802 N3		
"	D6 RA57					
"	D6 RA571					
"	D6 RA572					
(E1A-G1) 1,118 L - 1,294 L	Valeo	D9 E131	-	-	NFP	94 058 027 58 NFP
	"	D9 E132				
	Paris-Rhône	D9 E43				
	"	D9 E44				
	"	D9 E83				
	Bosch	9 000 333 104				
	"	9 000 333 106				
	Mitsubishi	M 003T 19771				
	"	M 003T 19871				
	"	M 003T 39781				
"	M 003T 39881					

POUR : FOR - PARA - PARA - FÜR - PER - VOOR

KW : PUISSANCE : POWER - POTENCIA - POTENCIA - LEISTUNG - POTENZA - VERMOGEN

NEUF : NEW - NUEVO - NOVO - NEU - NUOVO - NIEUW

E.S. ECHANGE STANDARD : STANDARD EXCHANGE - CAMBIO ESTANDARD - R.RENOVADO - AUSTAUSCH - REVISIONATO - FABRIEKSRUIL

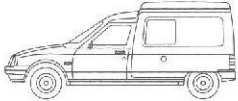
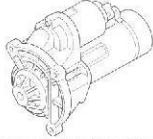
						<b>CITROËN C15</b>	
	Fournisseur Supplier Proveedor Fornecedor Lieferant Fornitore Leverancier	Repère Identification mark Marca Referencia Bauteilmarkierung Riferimento Merkteken	Classe Class Clase Classe Klasse Classe Klasse	KW			
					Neuf	E.S.	
<b>Diesel - Gasoleo</b>							
(XUD) 1,8 L  <i>Pour Peugeot 205</i>	Valeo " Mitsubishi " " " Bosch "	D9 R121 D9 R84 M 001T 80081 M 001T 90281 M 001T 50171 M 001T 50172 0 001 110 017 0 001 314 034		5	1,7	5802 C3 RP 5802 M3	5802 H8
(DW8B) 1,9 L  <i>Pour Peugeot 205-306</i>	Valeo Bosch Mitsubishi	D6 RA109 0 001 108 183 M 001 T 80381		4	1,4	5802 W5	5802 W9
	Valeo " " " Mitsubishi "	D7 R2 D7 R4 D7 R8 D7 R26 M 001 T 80082 M 001 T 80481		5	1,7	5802 M3 12/2000 →	5802 V5

POUR : FOR - PARA - PARA - FÜR - PER - VOOR

KW : PUISSANCE : POWER - POTENCIA - POTENCIA - LEISTUNG - POTENZA - VERMOGEN

NEUF : NEW - NUEVO - NOVO - NEU - NUOVO - NIEUW

E.S. ECHANGE STANDARD : STANDARD EXCHANGE - CAMBIO ESTANDARD - R.RENOVADO - AUSTAUSCH - REVISIONATO - FABRIEKSRUIL



# CITROËN BERLINGO

## (VP - VU)

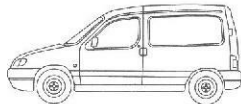
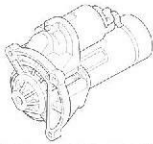
	Fournisseur Supplier Proveedor Fornecedor Lieferant Fornitore Leverancier	Repère Identification mark Marca Referencia Bauteilmarkierung Riferimento Merkteken	Classe Class Clase Classe Klasse Classe Klasse	KW		
					Neuf	E.S.
<b>Essence - Petrol - Gazolina - Gasolina - Benzin - Benzina - Benzine</b>						
(TU1 - TU3) 1,1 L - 1,4 L	Valeo	D7 E7	1		5802 Q7 RP 5802 M9	5802 Q9
	"	D7 E16				
	"	D7 E71				
(TU5JP4) 1,6 L 16 S	Bosch	0 001 116 003	2	0,9	5802 M9	5802 P8
	Mitsubishi	M 002T 13081				
	Valeo	D7 E2				
<i>Pour Peugeot PARTNER</i>	"	D7 E5	3	1,1	5802 C9	5802 N3
	"	D7 E23				
	Ducellier	534 054				
(XU7JB) 1,8 L	Iskra	AZE 1521	3	1,1	5802 E4	5802 Q2
	"	AZE 1523				
	Bosch	0 001 112 007				
<i>Pour Peugeot PARTNER</i>	"	0 001 112 019	4	1,4	5802 E5	5802 H4
	"	0 001 112 029				
	"	0 001 112 041				

POUR : FOR - PARA - PARA - FÜR - PER - VOOR

KW : PUISSANCE : POWER - POTENCIA - POTENCIA - LEISTUNG - POTENZA - VERMOGEN

NEUF : NEW - NUEVO - NOVO - NEU - NUOVO - NIEUW

E.S. ECHANGE STANDARD : STANDARD EXCHANGE - CAMBIO ESTANDARD - R.RENOVADO - AUSTAUSCH - REVISIONATO - FABRIEKSRIJL

# CITROËN BERLINGO (VP - VU)

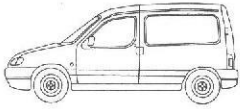

Fournisseur  
Supplier  
Proveedor  
Fornecedor  
Lieferant  
Fornitore  
Leverancier

Repère  
Identification mark  
Marca  
Referencia  
Bauteilmarkierung  
Riferimento  
Merkteken

Classe  
Class  
Clase  
Classe  
Klasse  
Klasse  
Klasse

KW

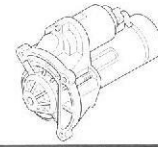

Neuf

E.S.

## Diesel - Gasoleo

(XUD7) <b>1,8 L</b> (XUD9 - DW8 - DW8B) <b>1,9 L Atmo</b>  (DW10TD - DW10ATE) <b>2 L Turbo</b>  <i>Pour Peugeot PARTNER</i>	Valeo	D7 R2	5	1,7	5802 M3	5802 V5
	"	D7 R4				
	"	D7 R8	6	2	5802 M4	5802 V6
	"	D7 R26				
	Mitsubishi	M 001T 80082	4	1,4	5802 W5	5802 W9
	"	M 001T 80481				
	Valeo	D7 R12	4	1,4	5802 W5	5802 W9
	"	D7 R27				
(DW8 - DW8B) <b>1,9 L Atmo</b> (DW10TD) <b>2L Turbo</b>  <i>Pour Peugeot PARTNER</i>	Valeo	D6 RA 109	4	1,4	5802 W5	5802 W9
	Bosch	0 001 108 183				
	Mitsubishi	M 001T 80381	4	1,4	5802 W5	5802 W9

POUR : FOR - PARA - PARA - FÜR - PER - VOOR

KW : PUISSANCE : POWER - POTENCIA - POTENCIA - LEISTUNG - POTENZA - VERMOGEN

NEUF : NEW - NUEVO - NOVO - NEU - NUOVO - NIEUW

E.S. ECHANGE STANDARD : STANDARD EXCHANGE - CAMBIO ESTANDARD - R.RENOVADO - AUSTAUSCH - REVISIONATO - FABRIEKSRUIL

# CITROËN JUMPY

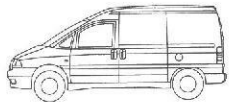
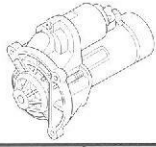
	Fournisseur Supplier Proveedor Fornecedor Lieferant Fornitore Leverancier	Repère Identification mark Marca Referencia Bauteilmarkierung Riferimento Merkteken	Classe Class Clase Classe Klasse Klasse	KW		
					Neuf	E.S.
<b>Essence - Petrol - Gazolina - Gasolina - Benzin - Benzina - Benzine</b>						
(SPI) 1,6 L  <i>Pour Peugeot EXPERT</i>	Magneti Marelli	63 223 101	3	1,1	5802 M1	-
(EW10J4) 2 L 16S  <i>Pour Peugeot EXPERT</i>	Valeo Mitsubishi	D6 RA74 M 000T 82081	3	1,1	5802 V7	5802 W3
	Mitsubishi	M 000T 85381	4	1,4	5802 V8	5802 W4
<b>Diesel - Gasoleo</b>						
(XUD9 - DW8 - XUD9TE) 1,9 L Atmo - 1,9 L Turbo (DW10ATE) 2 L Turbo  <i>Pour Peugeot EXPERT</i>	Valeo " " " Mitsubishi "	D7 R2 D7 R4 D7 R8 D7 R26 M 001T 80082 M 001T 80481	5	1,7	5802 M3	5802 V5
	Valeo "	D7 R12 D7 R27	6	2	5802 M4	5802 V6
(DW8 - DW10ATE) 1,9 L Atmo - 2 L Turbo 10/99 →  <i>Pour Peugeot EXPERT</i>	Valeo Bosch Mitsubishi	D6 RA 109 0 001 108 183 M 001T 80381	4	1,4	5802 W5	5802 W9

POUR : FOR - PARA - PARA - FÜR - PER - VOOR

KW : PUISSANCE : POWER - POTENCIA - POTENCIA - LEISTUNG - POTENZA - VERMOGEN

NEUF : NEW - NUEVO - NOVO - NEU - NUOVO - NIEUW

E.S. ECHANGE STANDARD : STANDARD EXCHANGE - CAMBIO ESTANDARD - R.RENOVADO - AUSTAUSCH - REVISIONATO - FABRIEKSRUIL

# CITROËN JUMPER

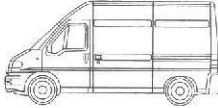
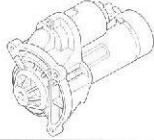
	Fournisseur Supplier Proveedor Fornecedor Lieferant Fornitore Leverancier	Repère Identification mark Marca Referencia Bauteilmarkierung Riferimento Merkteken	Classe Class Clase Classe Klasse Classe Klasse	KW		
					Neuf	E.S.
<b>Essence - Petrol - Gazolina - Gasolina - Benzin - Benzina - Benzine</b>						
(XU10J2) 2 L  <i>Pour Peugeot BOXER</i>	Valeo " " " Bosch "	D6 RA16 D6 RA38 D6 RA66 D6 RA661 0 001 107 019 0 001 107 063	3	1,1	5802 E4	5802 Q2
	Bosch "	0 001 108 085 0 001 108 176	4	1,4	5802 E5	5802 H4
<b>Diesel - Gasoleo</b>						
(XUD9) 1,9 L (DW10TD - DW12TED) 2 L Turbo - 2,2 L Turbo  <i>Pour Peugeot BOXER</i>	Valeo " " " Mitsubishi "	D7 R2 D7 R8 D7 R4 D7 R26 M 001T 80082 M 001T 80481	5	1,7	5802 M3	5802 V5
(XUD9 - DW10TD) 1,9 L - 2 L Turbo  <i>Pour Peugeot BOXER</i>	Valeo "	D7 R12 D7 R27	6	2	5802 M4	5802 V6
(DW12TED) 2,2 L Turbo  <i>Pour Peugeot BOXER</i>	Bosch	0 001 233 014	6	2	5802 W7	-

POUR : FOR - PARA - PARA - FÜR - PER - VOOR

KW : PUISSANCE : POWER - POTENCIA - POTENCIA - LEISTUNG - POTENZA - VERMOGEN

NEUF : NEW - NUEVO - NOVO - NEU - NUOVO - NIEUW

E.S. ECHANGE STANDARD : STANDARD EXCHANGE - CAMBIO ESTANDARD - R.RENOVADO - AJUSTAUSCH - REVISIONATO - FABRIEKSRUIL

# CITROËN JUMPER

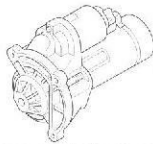
	Fournisseur Supplier Proveedor Fornecedor Lieferant Fornitore Leverancier	Repère Identification mark Marca Referencia Bauteilmarkierung Riferimento Merkteken	Classe Class Clase Classe Classe Klasse	KW		
					Neuf	E.S.
<b>Diesel - Gasoleo</b>						
(DJ5-DJ5T-DJ5TED) 2,5 L - 2,5 L Turbo  <i>Pour Peugeot BOXER</i>	Bosch	0 001 223 001	6	2	5802 F6	5802 H6
(SOFIM) 2,8 L Sauf HDI  <i>Pour Peugeot BOXER</i>	Bosch Magneti Marelli	0 001 218 159 E95RL-2,6KW	6	2	5802 V4	5802 Y2
(SOFIM) 2,8 L HDI  <i>Pour Peugeot BOXER</i>	Denso	63 114 014	5	-	5802 Y9	5802 Z2
	Bosch	0 001 223 013	-	-	5802 Z0	5802 Z4

POUR : FOR - PARA - PARA - FÜR - PER - VOOR

KW : PUISSANCE : POWER - POTENCIA - POTENCIA - LEISTUNG - POTENZA - VERMOGEN

NEUF : NEW - NUEVO - NOVO - NEU - NUOVO - NIEUW

E.S. ECHANGE STANDARD : STANDARD EXCHANGE - CAMBIO ESTANDARD - R.RENOVADO - AUSTAUSCH - REVISIONATO - FABRIEKSRUIL

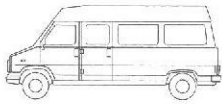
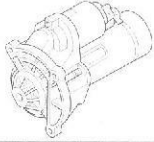
					<b>CITROËN C25</b>	
	Fournisseur Supplier Proveedor Fornecedor Lieferant Fornitore Leverancier	Repère Identification mark Marca Referencia Bauteilmarkierung Riferimento Merkteken	Classe Class Clase Classe Classe Classe	KW		
					Neuf	E.S.
<b>Essence - Petrol - Gazolina - Gasolina - Benzin - Benzina - Benzine</b>						
(XM7T-XN1T) 1,8 L - 2 L  <i>Pour Peugeot J5</i>	Paris-Rhône	D8 E76	3	1,1	5802 82	5802 P5
	"	D8 E96				
	"	D8 E122				
	"	D8 E124				
	"	D9 E36				
	"	D9 E54				
	"	D9 E61				
	"	D9 E62				
	Bosch	0 001 208 211				
	"	0 001 208 507				
	Ducellier	534 046				
	"	534 050				
	"	6 189 AF				
"	6 242					
Femsa	M OC12-2					

POUR : FOR - PARA - PARA - FÜR - PER - VOOR

KW : PUISSANCE : POWER - POTENCIA - POTENCIA - LEISTUNG - POTENZA - VERMOGEN

NEUF : NEW - NUEVO - NOVO - NEU - NUOVO - NIEUW

E.S. ECHANGE STANDARD : STANDARD EXCHANGE - CAMBIO ESTANDARD - R.RENOVADO - AUSTAUSCH - REVISIONATO - FABRIEKSUIJL

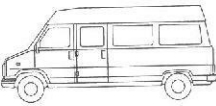
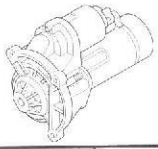

<b>CITROËN C25</b>						
	Fournisseur Supplier Proveedor Fornecedor Lieferant Fornitore Leverancier	Repère Identification mark Marca Referencia Bauteilmarkierung Riferimento Merkteken	Classe Class Clase Classe Klasse Klasse	KW		
					Neuf	E.S.
<b>Diesel - Gasoleo</b>						
(XUD) <b>1,9 L Atmo</b>  <i>Pour Peugeot J5</i>	Valeo " Mitsubishi " " " Bosch " "	D9 R84 D9 R121 M 001T 80081 M 001T 90281 M 001T 50171 M 001T 50172 0 001 110 017 0 001 314 034 0 001 109 026	5	1,7	<i>5802 C3</i> <b>RP 5802 M3</b>	<b>5802 H8</b>
(M705T) <b>1,9 L Turbo</b> (XT)	Magneti Marelli	63 222 034	-	-	<b>5802 E3</b>	-
(CRD) <b>2,5 L Atmo - Turbo</b> → 10/85  <i>Pour Peugeot J5</i>	Paris-Rhône " " " Ducellier " Bosch "	D11 E163 D11 E169 D11 E176 D11 E177 538 002 538 006A 0 001 218 003 0 001 218 020	6	2	<b>5802 85</b>	<b>95 580 181</b>
(CRD) <b>2,5 L Atmo - Turbo</b> 07/85 →  <i>Pour Peugeot J5</i>	Paris-Rhône	D9 R90	6	2		<b>5802 P7</b>
<p><b>POUR</b> : FOR - PARA - PARA - FÜR - PER - VOOR  <b>KW</b> : PUISSANCE : POWER - POTENCIA - POTENCIA - LEISTUNG - POTENZA - VERMOGEN  <b>NEUF</b> : NEW - NUEVO - NOVO - NEU - NUOVO - NIEUW  <b>E.S. ECHANGE STANDARD</b> : STANDARD EXCHANGE - CAMBIO ESTANDARD - R.RENOVADO - AUSTAUSCH - REVISIONATO - FABRIEKSRUIL</p>						

## 2CV-LN-LNA-VISA

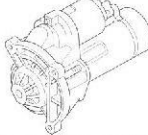
	Fournisseur Supplier Proveedor Fornecedor Lieferant Fornitore Leverancier	Repère Identification mark Marca Referencia Bauteilmarkierung Riferimento Merkteken	Classe Class Clase Classe Classe Classe Klasse	KW		
					Neuf	E.S.
<b>Essence - Petrol - Gazolina - Gasolina - Benzin - Benzina - Benzine</b>						
<b>2CV 4-2CV 6 Dyane-Mehari-Ami 8 250-400-Acadiane</b>	Valeo Bosch Paris Rhône " " " Ducellier Femsa Iskra	D6 RA43 9 000 141 104 D8 E99 D8 E116 D8 E148 D9 E93 6202 ABCDEF MTA 12-30 AZE 03-05	2	0,9	5 473 630 NFP	5802 Q4
<b>(2 cyl.) LN-LNA-Visa</b>	Valeo Bosch Ducellier Paris Rhône " Iskra " Femsa Magnet Marelli	D6 RA44 9 000 334 101 532 012 AB D9 E94 D8 E154 AZD 0102 AZE 0308 MTA 12-40 63 220 535	2	0,9	5 500 926 NFP	5802 N7
<b>(4 cyl.) LNA  Pour Peugeot 104- 205</b>	Valeo " " " Bosch " " " Ducellier " "	D8 E117 D8 E151 D9 E64 D9 E75 0 001 208 226 0 001 208 228 0 001 208 518 9 000 142 002 6220 AC 532 014 AB 534 048	3	1,1	5802 45	5802 P4
<b>(4 cyl.) Visa → 04/81  Pour Peugeot 104</b>	Ducellier " Paris Rhône "	6216 AC 532 020 AB D8 E107 D9 E64				5802 N8 RP 5802 P4

POUR : FOR - PARA - PARA - FÜR - PER - VOOR

KW : PUISSANCE : POWER - POTENCIA - POTENCIA - LEISTUNG - POTENZA - VERMOGEN

NEUF : NEW - NUEVO - NOVO - NEU - NUOVO - NIEUW

E.S. ECHANGE STANDARD : STANDARD EXCHANGE - CAMBIO ESTANDARD - R.RENOVADO - AUSTAUSCH - REVISIONATO - FABRIEKSRUIL

# 2CV-LN-LNA-VISA

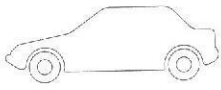
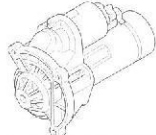
	Fournisseur Supplier Proveedor Fornecedor Lieferant Fornitore Leverancier	Repère Identification mark Marca Referencia Bauteilmarkierung Riferimento Merkteken	Classe Class Clase Classe Klasse Klasse	KW		
					Neuf	E.S.
<b>Essence - Petrol - Gazolina - Gasolina - Benzin - Benzina - Benzine</b>						
(4 cyl.) Visa Sauf GTI 04/81 →  <i>Pour Peugeot 104-205</i>	Bosch	0 001 208 226			5802 45	5802 P4
	"	0 001 208 228				
	"	0 001 208 518				
	"	9 000 142 002				
	Ducellier	532 014 AB	3	1,1		
	"	534 048				
	"	6220 AC				
	Paris Rhône	D8 E117				
	"	D8 E151				
	"	D9 E64				
	"	D9 E75				
Visa GTI  <i>Pour Peugeot 205-305-309</i>	Valeo	D6 RA8			5802 E4	5802 P3
	"	D6 RA18				
	Bosch	0 001 208 516				
	"	0 001 208 707				
	Ducellier	534 039				
	Iskra	AZF 3528				
	Paris Rhône	D9 E48				
	"	D9 E49				
<b>Diesel - Gasoleo</b>						
(XUD) Visa 1769 cm <sup>3</sup>  <i>Pour Peugeot 205-305-309</i>	Valeo	D7 R84	5	1,7	5802 C3 RP 5802 M3	5802 H8
	"	D9 R121				
	Mitsubishi	M 001T 50171				
	"	M 001T 50172				
	"	M 001T 90281				
	"	M 001T 80081				
	Bosch	0 001 110 017				
	"	0 001 314 034				

POUR : FOR - PARA - PARA - FÜR - PER - VOOR

KW : PUISSANCE : POWER - POTENCIA - POTENCIA - LEISTUNG - POTENZA - VERMOGEN

NEUF : NEW - NUEVO - NOVO - NEU - NUOVO - NIEUW

E.S. ECHANGE STANDARD : STANDARD EXCHANGE - CAMBIO ESTANDARD - R.RENOVADO - AUSTAUSCH - REVISIONATO - FABRIEKSRUIL

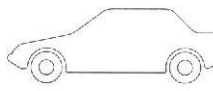
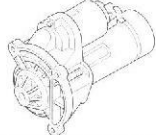
					<b>GS-GSA-AXEL-AMI</b>	
	Fournisseur Supplier Proveedor Fornecedor Lieferant Fornitore Leverancier	Repère Identification mark Marca Referencia Bauteilmarkierung Riferimento Merkteken	Classe Class Class Classe Klasse Klasse	KW		
					Neuf	E.S.
<b>Essence - Petrol - Gazolina - Gasolina - Benzin - Benzina - Benzine</b>						
<b>GS-GSA-AXEL AMI Super</b>	Paris Rhône " Femsa " Ducellier " "	D8 E103 D8 E155 MOB 12-1 MOB 12-2 6208 6217ABCDEFGH 532 016 AB	-	-	<b>NFP</b>	<b>5802 N9</b>

KW : PUISSANCE : POWER - POTENCIA - POTENCIA - LEISTUNG - POTENZA - VERMOGEN

NEUF : NEW - NUEVO - NOVO - NEU - NUOVO - NIEUW

E.S. EXCHANGE STANDARD : STANDARD EXCHANGE - CAMBIO ESTANDARD - R.RENOVADO - AUSTAUSCH - REVISIONATO - FABRIEKSRIJL

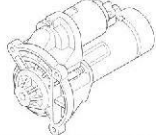
<b>CX</b>						
	Fournisseur Supplier Proveedor Fornecedor Lieferant Fornitore Leverancier	Repère Identification mark Marca Referencia Bauteilmarkierung Riferimento Merkteken	Classe Class Clase Klasse Classe Klasse	KW		
					Neuf	E.S.
<b>Essence - Petrol - Gazolina - Gasolina - Benzin - Benzina - Benzine</b>						
<b>CX 2 L - 2,2 L → 07/79</b>	Paris Rhône " "	D9 E16 D9 E21 D9 E40	-	-	<b>91 521 310</b> deo(1) 95 615 135	<b>5802 P0</b>
<b>CX 2,4 L - IE → 07/83</b>	Ducellier " "	6236 ABC 534 009 AC 536 001 A			<b>NFP</b>	
<b>CX 2 L - 2,2 L</b> 07/79 → 01/84	Valeo " " "	D8 E140 D9 E86 D9 E861 D9 E701 D9 E702	3	1,1	<b>5802 47</b>	<b>5802 P6</b>
<b>CX 20-22</b> 07/79 → 01/84	Ducellier Paris Rhône	532 004 ABC D9 E70				
<b>CX IE 07/83 →</b>	Mitsubishi	M 002T 50485	-	-	<b>91 521 310</b>	<b>95 619 196</b>
<b>CX Ess 2 - 2,2 L</b> (S) (N) (SF)	Paris-Rhône	D10 E88	-	-	7 700 757 741 <b>NFP</b>	-
<b>CX Ess 2,5 L IE BVA</b> Pays grands froids	Paris-Rhône	D9 R96	-	-	91 536 971 <b>NFP</b>	-
<b>Diesel - Gasoleo</b>						
<b>CX DI Atmo → 07/85</b>	Bosch " Ducellier " Paris Rhône " " "	0 001 218 003 0 001 218 020 538 002 538 006 A D11 E163 D11 E169 D11 E176 D11 E177	6	2	<b>5802 85</b>	<b>95 580 181</b>
<b>CX 25D Atmo</b> <b>CX 25D Turbo</b> 07/85 →	Valeo	D9 R90	6	2	<b>5802 85</b>	<b>5802 P7</b>
<p><b>KW : PUISSANCE : POWER - POTENCIA - POTENCIA - LEISTUNG - POTENZA - VERMOGEN</b>  <b>NEUF : NEW - NUEVO - NOVO - NEU - NUOVO - NIEUW</b>  <b>E.S. ECHANGE STANDARD : STANDARD EXCHANGE - CAMBIO ESTANDARD - R.RENOVADO - AUSTAUSCH - REVISIONATO - FABRIEKSRUIJ</b></p>						

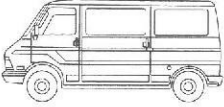
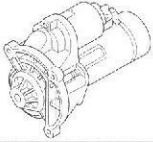



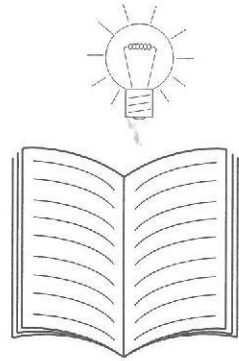
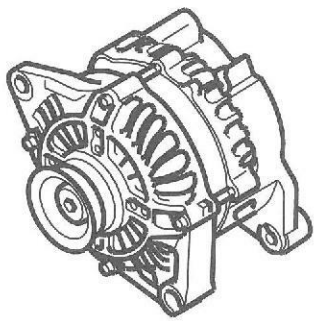

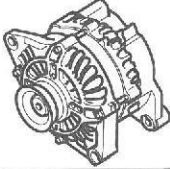
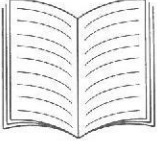
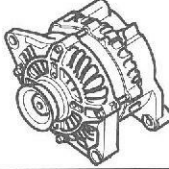
					<b>C35</b>	
	Fournisseur Supplier Proveedor Fornecedor Lieferant Fornitore Leverancier	Repère Identification mark Marca Referencia Bauteilmarkierung Riferimento Merkteken	Classe Class Clase Classe Classe Classe	KW		
					Neuf	E.S.
<b>Essence - Petrol - Gazolina - Gasolina - Benzin - Benzina - Benzine</b>						
2 L → 06/88	Ducellier	6215 BCD	-	-	NFP	5802 P2
2 L 06/88 →	Paris-Rhône	D9 E104	-	-	NFP	NFP
<b>Diesel - Gasoleo</b>						
2,2 L	Ducellier " " Paris-Rhône	538 000 AC 538 003 A 6230 AB D11 E164	-	-	NFP	95 580 172
2,5 L 01/80 → 01/87	Ducellier Paris-Rhône "	538 005 AB D11 E173 D11 E187	-	-	91 536 160 NFP	95 580 171
2,5 L 01/87 →	Paris-Rhône	D9 R97	-	-	91 536 160 NFP	95 643 763
<p>KW : PUISSANCE : POWER - POTENCIA - POTENCIA - LEISTUNG - POTENZA - VERMOGEN  NEUF : NEW - NUEVO - NOVO - NEU - NUOVO - NIEUW  E.S. ECHANGE STANDARD : STANDARD EXCHANGE - CAMBIO ESTANDARD - R.RENOVADO - AUSTAUSCH - REVISIONATO - FABRIEKSRIJL</p>						





			
5702 A1	20-29-38-48-49	5705 5T	19-21-46
5702 A9	50	5705 5U	19-21
5702 C1	50-51	5705 5V	19-21-29-39-46
5705 04	52	5705 5X	42
5705 11	23-40-53	5705 5Y	8-42
5705 1A	53	5705 5Z	7-8-42
5705 1B	54	5705 63	40
5705 1E	56	5705 6A	27-29-34-39
5705 1F	27-34	5705 6E	10
5705 1G	27-29-34	5705 6M	8-9-42
5705 1J	7-15-42	5705 6N	21-29-39
5705 1L	7-15-42	5705 6P	39
5705 1N	9-13	5705 6Q	50
5705 1Q	14-17-28-35-38-44-47	5705 6T	8-42
5705 1T	13-26-27-32-33-37-43	5705 6V	8-42
5705 1Y	7-15-42	5705 6X	8-41
5705 25	24-25-41-52-54	5705 6Z	19-21
5705 2A	18-20-21-41-45-46-48	5705 7C	19-21
5705 2B	18-19-20-21-29-37-41 45-46-48	5705 7F	19-21-29
5705 2C	18-19-20-21-22-28-29-37 38-41-45-46-48-49-51	5705 7H	8-9
5705 2D	18-19-20-21-22-28-29-37 38-45-47-48-49	5705 7K	16-26-33-36-50
5705 4C	50	5705 7M	49
5705 4E	50	5705 7P	29
5705 4F	18-20-22-28-29-37-38 45-48-51	5705 7R	47
5705 4G	7	5705 7T	47
5705 4N	7	5705 7V	50
5705 4P	7-8	5705 7X	50
5705 4Q	8-9	5705 7Z	50
5705 4S	29-48	5705 88	23
5705 4T	18-20-21-41-45-48	5705 89	6-23-40
5705 4V	18-19-20-21-29-37-41 45-48	5705 8J	22
5705 4X	18-19-20-21-22-28-29-37 38-45-47-48-49-51	5705 90	6-23-40
5705 4Z	18-19-20-21-22-28-29-37 38-45-47-48-49	5705 91	41
5705 5E	27-34	5705 97	25
5705 5G	27-29-34	5705 A0	24-25
5705 5J	18-20-22-28-29-37-38 45-48-51	5705 A2	30
5705 5L	7	5705 AA	20-29-38-39-48-49
5705 5N	7	5705 AC	10-20
5705 5Q	7-8	5705 AE	50
5705 5S	8-9	5705 AF	50-51
		5705 AJ	29-39
		5705 AK	51
		5705 AL	46
		5705 AP	10
		5705 AQ	10
		5705 E1	7-11-15-23-42
		5705 E2	7-8-11-15-42
		5705 E3	14-28

			
5705 E4	11-12-25-31-36	5705 X2	7-8-11-15-42
5705 E5	11-12-36	5705 X3	9-13
5705 E6	12-15-26-33-36-49-51	5705 X7	14-17-44-47
5705 E7	12-15-26-27-33-36-49-50-51	5705 X9	7-11-15-23-42
5705 E8	16-26-33-36-50	5705 Y0	7-8-11-15-42
5705 E9	52	5705 Y1	13-17-25-28-44-47
5705 F3	13-17-25-28-44-47	5705 Y2	14-17-28-43-47-49
5705 F4	14-17-28-43-44-49	5705 Y3	26-27-32
5705 G4	30-31-32-34	5705 Y4	28-35
5705 G5	30-31-32-34	5705 Y5	53
5705 G6	30-32-34	5705 Y6	52-55-56
5705 G7	24	5705 Y7	55-56
5705 G9	31-35	5705 Y8	55-56
5705 H1	31-35	5705 Y9	40-53
5705 H3	52-55	5705 Z0	24-25-41-52-54
5705 J2	31-35	5705 Z1	23
5705 J4	31-35	5705 Z2	52-55
5705 J9	6-13	5705 Z3	6-23-40
5705 K1	52-55-56	5705 Z4	25
5705 K3	30-31-35	5705 Z5	52-55-56
5705 K4	6	5705 Z6	6
5705 K7	14-17-28-35-38-44-47	5705 Z7	41
5705 L1	6-9-13-17	5705 Z8	55
5705 L2	6-9-13-17	5705 Z9	53
5705 L3	35-37	5 473 145	53
5705 L5	14-17-44-47	95 495 929	55
5705 L6	14-17-38-44-47	95 598 734	55
5705 L7	14-17-28-35-38-44-47	95 598 735	56
5705 M5	49	95 607 228	52
5705 M7	6-13	95 618 728	53
5705 M9	12-15-26-33-36-49-51	95 656 486	30
5705 N1	6-9-13-17	95 658 579	30-31-32-34
5705 N3	6-9-13-17	95 667 740	13-28
5705 N6	11-12-25-31-36	95 667 741	11-23
5705 N7	12-15-26-27-33-36-49	95 667 745	11-12-36
5705 P7	35-37	95 667 749	14-28
5705 R5	14-17-38-44-47	95 667 750	30-31-32-34
5705 R7	14-17-28-35-38-44-47	95 667 751	30-32-34
5705 R8	24-25	95 668 060	6-23-39
5705 R9	47	95 668 061	25
5705 S0	47		
5705 S2	12-16-19-26-27-32-33-37-43		
5705 S3	12-16-19-26-27-32-33-37-43		
5705 S4	12-13-16-19-26-27-32-33-37-43		
5705 S5	13-26-27-32-33-37-43		
5705 W4	12-16-19-26-27-32-33-37-43		
5705 W7	12-16-19-26-27-32-33-37-43		
5705 X0	13-16-19-26-27-32-33-37-43		

					
<b>BOSCH</b>		<b>MITSUBISHI</b>		<b>MOTOROLA</b>	
0 120 335 006	95 667 741	A 001T 02674	5705 Z3	9 AR 2672	95 607 228
0 120 335 007	5705 X9	A 002T 13391	95 658 579	9 AR 2673	95 607 228
0 120 335 012	5705 Y1	A 002T 17491	95 656 486	9 AR 2690	5705 Z2
0 120 488 129	5705 Z4	A 002T 17491	5705 N6	9 AR 2728	5705 Y9
0 120 488 214	5705 Z0	A 002T 17491	95 668 061	9 AR 2748	5705 1B
0 120 488 215	5705 Z0	A 002T 26391	5705 Z0	9 AR 2828	5705 1B
0 120 489 158	5705 Z0	A 002T 27091	5705 Z0	9 AR 2964	95 607 228
0 120 489 164	5705 Z1	A 002T 34598	5705 R8	9 AR 5096	5705 1A
0 120 489 194	5705 Z1	A 002T 37691	5705 M9	9 AR 5096	95 607 228
0 120 489 258	5705 Z1	A 002T 37692	95 658 579	9 AR 5097	5705 Y6
0 120 489 259	5705 Z0	A 002T A0291	5705 M9	<b>PARIS-RHONE</b>	
0 120 489 467	5705 Z3	A 002T A1991	5705 W7	A11M 4	5705 Z9
0 120 489 476	5705 Z3	A 002T A1994	5705 R5	A11M 6	5705 Z9
0 123 110 004	5705 N6	A 002T A1994	5705 X0	A11M 11	5705 Z9
0 123 110 004	95 668 061	A 002T A2091	5705 R7	A11M 12	5705 Z9
0 123 310 010	5705 R5	A 002T A2094	5705 R7	A12M 9	5705 Y5
0 123 310 011	5705 W7	A 002T B2191	5705 4V	A12M 11	5705 1A
0 123 310 012	5705 X7	A 002T B2291	5705 4X	A12M 16	5705 Y5
0 123 310 013	5705 W4	A 002T B4791	5705 4V	A12M 17	5705 1A
0 124 615 002	5705 5J	A 002T B4891	5705 4X	A12R 38	5705 1B
0 124 615 027	5702 A1	A 003T 03291	5705 Z7	A12R 43	5705 1A
9 120 144 243	5705 Z3	A 003T 03291	5705 R8	A12R 45	5705 Y5
9 120 144 243	5705 Y9	A 003T 03292	5705 R8	A12R 46	5705 1B
<b>DENSO</b>		A 003T 03298	5705 R8	A12R 53	5705 Y9
63 321 740	5705 6V	A 003T 45191	5705 Z7	A13N 38	5705 Y5
63 321 733	5705 6Z	A 003T 45191	5705 R8	A13N 38	5705 Y9
<b>DUCELLIER</b>		A 003T 45291	5705 Z7	A13N 38	5705 Z1
516 016	5705 Z8	A 003T 45292	5705 Z7	A13N 42	95 607 228
512 008 BE	5705 1A	A 003T 45292	5705 R8	A13N 43	5705 Z1
512 010 ABC	5705 Y5	A 003T 45298	5705 R8	A13N 93	5705 Z2
513 004 A	5705 Y9	A 003T A0591	5705 N7	A13N 95	5705 Z0
514 005 ABCDF	5705 Y9	A 003T A0593	5705 J4	A13N 129	5705 Z3
514 006 AB	5705 1B	A 003T A5591	5705 1Q	A13N 130	95 668 060
514 013 AB	5705 Y5	A 003T A6491	5705 4Z	A13N 167	5705 Z4
516 013 ABC	5705 Z5	A 003T B0891	5705 4Z	A13N 175	5705 Z3
7532 AD	5705 Z9	A 004T 00891	95 667 750	A13N 181	5705 Z0
7534 AD	5705 Z9	A 004T 00991	95 667 751	A13N 182	5705 Z4
<b>FEMSA</b>		A 004T 02891	5705 N7	A13N 215	5705 Z3
ALD 12N53	95 618728	A 004T 02892	95 667 750	A13N 216	95 668 060
ALN 12-1	5705 Z9	A 004T 02893	5705 J4	A13N 247	5705 Z5
ALP 12-17	5705 1B	A 004T 03292	95 667 750	A14N 1	5705 Z5
ALT 12N28	5705 1A	A 004T 03293	5705 J4	A14N 2	5705 Z5
ALT 12N43	5705 1A	A 004T 03392	95 667 751	A14N 22	5705 Z8
<b>ISKRA</b>		A 004T 03491	5705 7K	A14N 55	5705 Z5
AAG 0702	5705 Z9	A 004T 03492	95 667 751	A14N 90	5705 Y6
<b>LUCAS</b>		A 004T A0091	5705 7K	A14N 91	5705 Y6
23 987	5705 1A	A 004T A0092	95 667 751	A14N 91	5705 Y7
<b>MAGNETI MARELLI</b>		A 004T A0094	5705 7M	A14N 91	5705 Y8
63 321 204	5705 7R	A 004T A0592	95 667 750	A14N 91	5705 Z5
63 321 237	5705 7T	A 004T F0091	5705 5J	A14N 93	5705 Z2
63 321 641	5705 X9	A 005T A6291	5705 6Z	A14N 93	5705 Z8
63 321 671	5705 1Y	A 005T A6391	5705 7C	A14R 3	5705 Y8
63 321 723	5705 Y0	<b>MOTOROLLA</b>		A14R 11	5705 Y8
63 321 734	5705 7C	2 940 255	5705 1A	A14R 22	5705 Y7
63 321 741	5705 6T	2 940 255	95 618 728	<b>SEV</b>	
63 321 741	5705 6X	2 940 426	5705 Z2	71 333 102	5705 Y8
63 321 770	5705 X9	2 940 426	5705 Z8	71 770 102	5705 Z8
63 321 771	5705 1Y	2 941 097	5705 Y9	<b>VALEO</b>	
63 321 772	5705 Y0	9 AL 2505	5705 Y8	2 940 275	5705 Y6
63 321 820	5705 7R	9 AL 2628	5705 Y7	A11R 3	95 618 728
		9 AL 2696	5705 Z9		
		9 AR 2662	5705 1A		
		9 AR 2672	5705 Z2		





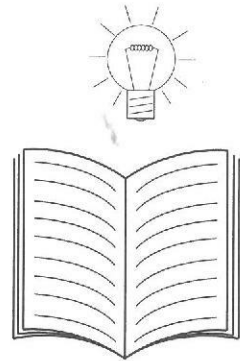
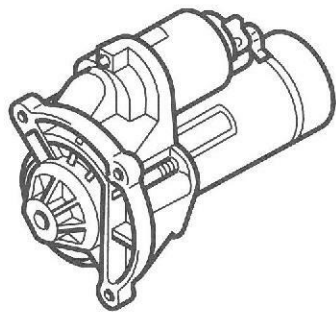



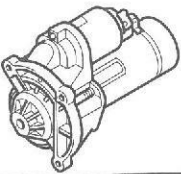
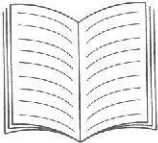
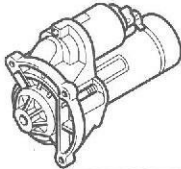
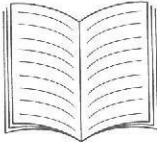

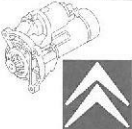

			
5802 45	67-76-85-86	5802 Q0	72
5802 47	88	5802 Q1	58-76
5802 82	83	5802 Q2	62-64-69-72-74-78-81
5802 85	84-88	5802 Q3	59-60-65
5802 A2	68	5802 Q4	85
5802 A8	72	5802 Q7	60-61-64-66-78
5802 A9	72	5802 Q9	60-61-64-66-78
5802 C3	68-72-73-74-77-84-86	5802 V4	81
5802 C4	70-73	5802 V5	63-65-66-70-71-74-77 79-80-81
5802 C9	58-60-61-62-64-66-70-76 78-79	5802 V6	63-65-66-70-71-74-79 80-81
5802 E3	84	5802 V7	64-66-71-74-75-80
5802 E4	62-64-67-68-69-72-74-78 81-86	5802 V8	64-66-71-74-75-80
5802 E5	62-64-69-72-74-78-81-84	5802 W0	69-72
5802 E6	62-69	5802 W3	64-66-71-74-80
5802 E7	62-69	5802 W4	64-66-71-74-80
5802 E9	59-60-63-65	5802 W5	65-66-74-79-80
5802 F6	81	5802 W6	71-75
5802 G2	58-59-60-65	5802 W7	71-75-81
5802 G4	73	5802 W9	65-66-79-80
5802 H3	69	5802 X8	71
5802 H4	62-64-69-72-74-78-81	5802 Y0	71
5802 H6	81	5802 Y2	81
5802 H7	70-73	5802 Y4	61-65
5802 H8	68-70-73-74-77-84-86	5802 Y9	81
5802 L8	73	5802 Z0	81
5802 M0	58-59-60-65	5802 Z2	81
5802 M1	80	5802 Z4	81
5802 M3	63-65-66-68-70-71-73-74 75-77-79-80-81-84-86	5802 Z8	61
5802 M4	63-65-66-68-70-71-73 74-79-80-81	5 473 630	85
5802 M9	60-61-64-66-67-76-78	5 500 926	85
5802 N3	58-60-61-62-64-66-76-78	91 507 478	68
5802 N4	69-72	91 521 310	88
5802 N7	85	91 536 160	90
5802 N8	85	91 536 971	88
5802 N9	87	95 580 171	89
5802 P0	88	95 580 172	89
5802 P2	89	95 580 181	84-88
5802 P3	76-68-86	95 615 135	88
5802 P4	67-76-85-86	95 619 196	88
5802 P5	83	95 643 763	89
5802 P6	88	95 667 755	62-69
5802 P7	84-88	96 028 857	58
5802 P8	58-60-61-64-66-67-76-78	7 700 757 741	88
		94 058 027 58	76

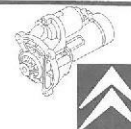
					
<b>BOSCH</b>		<b>DUCELLIER</b>		<b>PARIS-RHONE</b>	
0 001 107 019	5802 Q2	538 006 A	95 580 181	D8 E154	5802 N7
0 001 107 063	5802 Q2	6189 AF	5802 P5	D8 E155	5802 N9
0 001 108 074	5802 Q3	6202 ABCDEF	5802 Q4	D9 E16	5802 P0
0 001 108 085	5802 H4	6208	5802 N9	D9 E21	5802 P0
0 001 108 112	5802 Q3	6215 BCD	5802 P2	D9 E36	5802 P5
0 001 108 125	5802 Q3	6216 AC	5802 N8	D9 E40	5802 P0
0 001 108 128	5802 H3	6217 ABCDEFGH	5802 N9	D9 E43	94 058 027 58
0 001 108 162	5802 Q3	6220 AC	5802 P4	D9 E44	94 058 027 58
0 001 108 176	5802 H4	6230 AB	95 580 172	D9 E48	5802 P3
0 001 108 183	5802 W9	6236 ABC	5802 P0	D9 E49	5802 P3
0 001 109 026	5802 H8	6242	5802 P5	D9 E54	5802 P5
0 001 110 017	5802 H8	<b>FEMSA</b>		D9 E61	5802 P5
0 001 112 007	5802 P8	MOB 12-1	5802 N9	D9 E62	5802 P5
0 001 112 019	5802 P8	MOB 12-2	5802 N9	D9 E64	5802 P4
0 001 112 029	5802 P8	MOC 12-2	5802 P5	D9 E64	5802 N8
0 001 112 041	5802 P8	MTA 12-30	5802 Q4	D9 E70	5802 P6
0 001 116 003	5852 Q9	MTA 12-40	5802 N7	D9 E75	5805 P4
0 001 208 211	5802 P5	<b>ISKRA</b>		D9 E83	94 058 027 58
0 001 208 226	5802 P4	AZD 0102	5802 N7	D9 E93	5802 Q4
0 001 208 228	5802 P4	AZE 0305	5802 Q4	D9 E94	5802 N7
0 001 208 507	5802 P5	AZE 0308	5802 N7	D9 R90	5802 P7
0 001 208 516	5802 P3	AZE 1521	5802 P8	D9 R97	95 643 763
0 001 208 518	5802 P4	AZE 1523	5802 P8	D9E 104	95 653 969
0 001 208 707	5802 P3	AZF 3528	5802 P3	D11 E163	95 580 181
0 001 218 003	95 580 181	<b>MAGNETI MARELLI</b>		D11 E164	95 580 172
0 001 218 020	95 580 181	63 220 535	5802 N7	D11 E169	95 580 181
0 001 218 157	5802 L8	E95RL-2,6KW	5802 Y2	D11 E173	95 580 171
0 001 218 159	5802 Y2	<b>MITSUBISHI</b>		D11 E176	95 580 181
0 001 223 001	5802 H6	M 000T 80381	5802 W9	D11 E177	95 580 181
0 001 223 013	5802 Z4	M 000T 82081	5802 W3	D11 E187	95 580 171
0 001 223 014	5802 Y0	M 000T 85381	5802 W4	<b>VALEO</b>	
0 001 314 034	5802 H8	M 001T 50171	5802 H8	D6 RA5	5802 Q1
9 000 141 104	5802 Q4	M 001T 50172	5802 H8	D6 RA8	5802 P3
9 000 142 002	5802 P4	M 001T 80082	5802 V5	D6 RA10	5802 Q1
9 000 333 104	94 058 027 58	M 001T 80481	5802 V5	D6 RA12	5802 Q0
9 000 333 106	94 058 027 58	M 001T 90281	5802 H8	D6 RA16	5802 Q2
9 000 334 101	5802 N7	M 002T 13081	5802 Q9	D6 RA18	5802 P3
<b>DENSO</b>		M 002T 50485	95 619 196	D6 RA20	5802 Q1
633 11 014	5802 Z2	M 002T 84771	5802 L8	D6 RA37	5802 N3
<b>DUCELLIER</b>		M 002T 85582	5802 L8	D6 RA38	5802 Q2
532 004 BC	5802 P6	M 003T 19771	94 058 027 58	D6 RA43	5802 Q4
532 012 AB	5802 N7	M 003T 19871	94 058 027 58	D6 RA44	5802 N7
532 014 AB	5802 P4	M 003T 39781	94 058 027 58	D6 RA51	95 667 755
532 016 AB	5802 N9	M 003T 39881	94 058 027 58	D6 RA57	5802 N3
532 020 AB	5802 N8	<b>PARIS-RHONE</b>		D6 RA66	5802 Q2
534 009 AC	5802 P0	D8 E76	5802 P5	D6 RA72	5802 Q0
534 039	5802 P3	D8 E96	5802 P5	D6 RA74	5802 W3
534 046	5802 P5	D8 E99	5802 Q4	D6 RA100	5802 Q3
534 048	5802 P4	D8 E103	5802 N9	D6 RA107	5802 X8
534 050	5802 P5	D8 E107	5802 N8	D6 RA109	5802 W9
534 054	5802 P8	D8 E110	5802 N8	D6 RA511	95 667 775
534 055	5802 N3	D8 E116	5802 Q4	D6 RA571	5802 N3
534 055	5802 Q1	D8 E117	5802 P4	D5 RA572	5802 N3
536 001 A	5802 P0	D8 E122	5802 P5	D6 RA661	5802 Q2
538 002	95 580 181	D8 E124	5802 P5	D6 RA721	5802 Q0
538 003 A	95 580 172	D8 E148	5802 Q4	D7 E2	5802 P8
538 005 AB	95 580 171	D8 E151	5802 P4	D7 E5	5802 P8

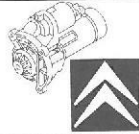
**VALEO**

D7 E7	5802 Q9
D7 E16	5802 Q9
D7 E23	5802 P8
D7 E71	5802 Q9
D7 R1	5802 Q3
D7 R2	5802 V5
D7 R3	5802 Q3
D7 R4	5802 V5
D7 R8	5802 V5
D7 R11	5802 Q3
D7 R12	5802 V6
D7 R15	5802 M0
D7 R17	5802 W0
D7 R26	5802 V5
D7 R27	5802 V6
D7 R151	5802 M0
D8 E117	5802 P4
D8 E140	5802 P6
D8 E151	5802 P4
D9 E64	5802 P4
D9 E75	5802 P4
D9 E86	5802 P6
D9 E131	94 058 027 58
D9 E132	94 058 027 58
D9 E701	5802 P6
D9 E702	5802 P6
D9 E861	5802 P6
D9 R84	5802 H8
D9 R90	5802 P7
D9 R121	5802 H8
D9 R122	5802 H7

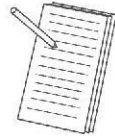

A large rectangular frame containing 20 horizontal lines, designed for writing or drawing.

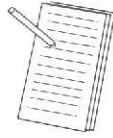

A large rectangular area containing horizontal lines for writing, typical of a notebook page. The lines are evenly spaced and extend across the width of the page. On the right side of the page, there are four circular punch holes for binding.

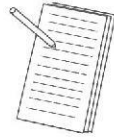

A large rectangular area containing 20 horizontal lines, intended for writing. The lines are evenly spaced and extend across most of the width of the page. On the left side of the page, there are four circular punch holes, indicating that this page is part of a binder or notebook.





A large rectangular area containing horizontal lines for writing, typical of a notebook page. The lines are evenly spaced and extend across the width of the page.



 Pour connaître les dernières dates de mise à jour, voir DOC FLASH : DIF/DOC/PMKSP

#### DROITS DE PROPRIETE

"Les droits de propriété intellectuelle relatifs aux informations techniques contenues dans cette brochure appartiennent exclusivement au Constructeur. Toute reproduction et/ou diffusion de tout ou partie de ces informations sont interdites sans autorisation écrite préalable du Constructeur."

"Les informations techniques contenues dans la présente documentation sont destinées exclusivement aux professionnels de la réparation automobile. Dans certains cas, ces informations peuvent concerner la sécurité des véhicules. Elles seront utilisées par les réparateurs automobiles auxquels elles sont destinées, sous leur entière responsabilité, à l'exclusion de celle du Constructeur."

"Les informations techniques figurant dans cette brochure peuvent faire l'objet de mises à jour en fonction de l'évolution des caractéristiques des modèles de chaque gamme.

Nous invitons les réparateurs automobiles à se mettre en rapport périodiquement avec le Constructeur/avec son réseau, pour se procurer les mises à jour nécessaires."

F

 To see the latest update refer to DOC FLASH : DIF/DOC/PMKSP

#### PROPERTY RIGHTS

"The intellectual copyrights relating to the technical information contained in this brochure are the exclusive property of the Manufacturer. Any reproduction and/or distribution of all or part of this information is forbidden without the Manufacturer's preliminary written authorisation."

"The technical information contained in this documentation is intended exclusively for automobile repair professionals. In certain cases, the information may relate to vehicle safety.

It will be used by the automobile repairers to whom it is addressed, on their full responsibility, to the exclusion of the Manufacturer's liability."

"The technical information that figures in this brochure may be updated in accordance with the changing features of models in each range.

We would request automobile repairers to get in touch with the Manufacturer/the network at regular intervals, to obtain the necessary updates."

GB

 Para conocer las últimas fechas de puesta al día, ver DOC FLASH : DIF/DOC/PMKSP

#### DERECHOS DE PROPIEDAD

"Los derechos de propiedad intelectual relativos a las informaciones técnicas que figuran en este folleto pertenecen exclusivamente al Constructor. Se prohíbe toda reproducción y/o difusión de la totalidad o parte de estas informaciones sin autorización previa y por escrito del Constructor."

"Las informaciones técnicas que figuran en la presente documentación están destinadas exclusivamente a los profesionales de la reparación de automóviles. En ciertos casos, pueden afectar a la seguridad de los vehículos.

Serán utilizadas por los reparadores de automóviles, a quienes están destinadas, bajo su entera responsabilidad, excluyéndose la del Constructor."

"Las informaciones técnicas que figuran en este folleto pueden ser objeto de actualizaciones en función de la evolución de las características de los modelos de cada gama.

Invitamos a los reparadores de automóviles a ponerse en contacto periódicamente con el Constructor/con su red, para conseguir las actualizaciones necesarias."

E

 Para saber as últimas datas de actualizaçao, ver DOC FLASH : DIF/DOC/PMKSP

#### DIREITOS DE PROPRIEDADE

"Os direitos de propriedade intelectual relativos às informações técnicas contidas nesta brochura pertencem exclusivamente ao Construtor. Qualquer reprodução e/ou difusão da totalidade ou parte destas informações são proibidas sem a autorização prévia e escrita do Construtor."

"As informações técnicas contidas na presente documentação destinam-se exclusivamente aos profissionais da reparação automóvel. Em certos casos, estas informações podem referir-se à segurança dos veículos.

Serão utilizadas pelos reparadores automóvel a que se destinam, sob a sua total responsabilidade, excluindo a responsabilidade do Construtor."

"As informações técnicas que figuram nesta brochura podem ser objecto de actualizações consoante a evolução das características dos modelos de cada gama.

Os reparadores automóvel são convidados a entrarem periodicamente em contacto com o Construtor/com a sua rede, para obterem as actualizações necessárias."

P

 Die Daten der aktuellen Ausgaben finden Sie in : DOC FLASH : DIF/DOC/PMKSP

#### EIGENTUMSRECHTE

"Die Rechte auf geistiges Eigentum in Verbindung mit den in der vorliegenden Broschüre enthaltenen technischen Informationen stehen ausschließlich dem Hersteller zu. Jede vollständige oder teilweise Reproduktion und/oder Verbreitung dieser Informationen sind ohne vorherige schriftliche Genehmigung des Herstellers verboten."

"Die in der vorliegenden Dokumentation enthaltenen technischen Informationen sind ausschließlich für Autoreparaturfachleute bestimmt. In einigen Fällen können diese Informationen die Sicherheit der Fahrzeuge betreffen.

Sie werden von den Kraftfahrzeughandwerkern, für die sie bestimmt sind, in ihrer eigenen Verantwortung benutzt, unter Ausschluss der Verantwortung des Herstellers."

"Die in dieser Broschüre enthaltenen technischen Informationen können je nach Fortentwicklung der verschiedenen Modelle in jeder Produktreihe aktualisiert werden.

Wir fordern die Kraftfahrzeughandwerker auf, sich regelmäßig an den Hersteller/an sein Vertriebsnetz zu wenden, um sich die erforderlichen Aktualisierungen zu beschaffen".

D

 Per conoscere l'ultima data agglomerato vedere DOC FLASH : DIF/DOC/PMKSP

#### DIRITTI DI PROPRIETÀ

"I diritti di proprietà intellettuale riguardanti le informazioni tecniche contenute nel presente manuale appartengono esclusivamente al Costruttore. Qualsiasi riproduzione e/o diffusione di tutto o parte di queste informazioni sono vietate senza autorizzazione preventiva scritta del Costruttore."

"Le informazioni tecniche contenute nella presente documentazione sono destinate esclusivamente agli autoriparatori. In alcuni casi, queste informazioni possono riguardare la sicurezza dei veicoli.

Esse verranno utilizzate dagli autoriparatori ai quali esse sono destinate sotto la loro piena responsabilità, ad esclusione di quella del Costruttore."

"Le informazioni tecniche contenute nel presente manuale possono essere soggetto ad aggiornamenti in funzione dell'evoluzione delle caratteristiche dei modelli di ogni gamma.

Invitiamo gli autoriparatori a mettersi in contatto periodicamente con il Costruttore/la sua rete, per procurarsi gli aggiornamenti necessari."

I

 Voor de laatste versiedatum, zie DOC FLASH : DIF/DOC/PMKSP

#### EIGENDOMSRECHT

"Het individuele eigendomsrecht betreffende technische informatie die in deze brochure staat vermeld behoort exclusief aan de Fabrikant. Alle reproductie en/of verspreiding van alles of een gedeelte van deze informatie is verboden zonder voorafgaande, schriftelijke toestemming van de Fabrikant."

"De technische informatie die in deze documentatie staat vermeld is alleen bestemd voor vakmensen in de branche van de automobielreparatie. In bepaalde gevallen kan deze informatie betrekking hebben op de veiligheid van de wagens.

Deze wordt gebruikt door automobielreparateurs waarvoor zij is bestemd, onder hun volledig verantwoordelijkheid, waardoor die van de Fabrikant vervalt."

"De technische informatie die in deze brochure staat vermeld kan onderhevig zijn aan aanvullingen als gevolg van een ontwikkeling in de technische gegevens van de modellen van elke serie.

Wij vragen de automobielreparateurs zich regelmatig met de Fabrikant of zijn netwerk in verbinding te stellen, om deze noodzakelijke aanvullingen te verkrijgen."

NL



ROULEMENTS  
BEARINGS  
RODAMIENTOS  
KUGELLAGER  
CUSCINETTI  
LAGERS

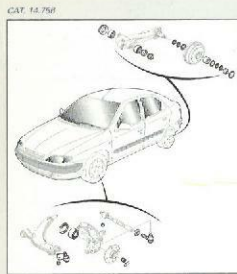

CAT. 14.766  
EDITION 1986

CITROËN

RETROVISEURS EXTERIEURS  
DOOR MIRRORS  
RETROVISORES EXTERIORES  
RETROVISORES EXTERIORES  
AUSSENESPEGEL  
RETROVISORE ESTERNO  
ZUSPIEGEL



CAT. 14.780

08/96

VITRAGE  
GLASS  
ACRISTALAMIENTO  
VIDROS  
SCHEIBEN  
VETRHATA  
RUITEN

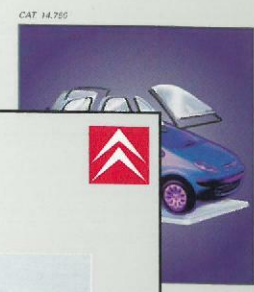

CAT. 14.785

03/000

ECHAPPEMENT  
EXHAUST  
ESCAPE  
ESCAPES  
AUSPUFFANLAGE  
SCARGO  
UWLATEN

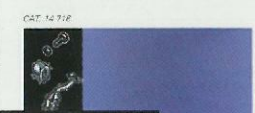

CAT. 14.712

TRANSMISSION  
DRIVESHAFT  
TRANSMISSIÖN  
TRANSMISSIÃO  
GELENKWELLE  
TRASMISSIONE  
AANDRIJFAS



CAT. 14.743

10/2001

RADIATEURS  
RADIATORS  
RADIADORES  
RADIADORES  
WASSERKÜHLER  
RADIATORI  
VANUIT



CAT. 14.783

ECLAIRAGE / SIGNALISATION  
LIGHTING  
ILUMINACION / SENALIZACION  
ILUMINACIÃO / SINALIZAÇÃO  
BELEUCHTUNG / FAHRRICHTUNGSANZEIGE  
ILLUMINAZIONE / SEGNALIZAZIONE  
VERLICHTING / SIGNALISERING



CAT. 14.786

02/0002

SUSPENSION  
SUSPENSION  
SUSPENSÃO  
SUSPENSÃO  
FEDRLUNG  
SOSPENSIONE  
VERING



CAT. 14.746

07/0002

EMBRAYAGE COMPLET / CABLE  
CLUTCH / CABLE  
CONJUNTO EMBRAGUE / CABLE  
EMBRAGAGEM COMPLETA / CABO  
KUPPLUNGSSATZ / KUPPLUNGSSZUG  
FRIZIONE COMPLETA / CAVO  
COMPLETE KOPPELING / KABEL

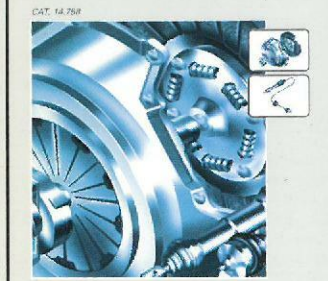

CAT. 14.758

CITROËN

MOTEUR - CLASSE TURBOCOMPRESSEUR  
ENGINE - CYLINDER HEAD - TURBO CHARGER  
MOTOR - CILINDRO TURBO COMPRESSOR  
MOTOR - CADEÇA DE MOTOR - TURBO-COMPRESSOR  
MOTOR - ZYLINDERKOPF - TURBOCOMPRESSOR  
MOTORE - TESTATA - TURBO COMPRESSORE  
MOTOR - CYLINDERKOPF - TURBO COMPRESSOR

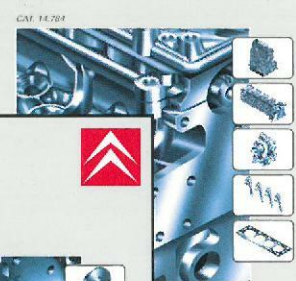

CAT. 14.784

09/2002

COURROIE  
BELT  
CORREA  
CORREIA  
KELRIEMEN  
CINGHIA  
RIEM

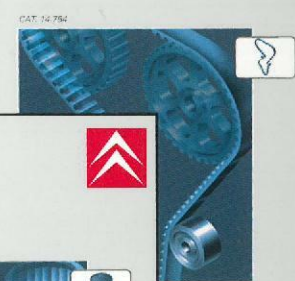

CAT. 14.784

07/0002

FREINAGE  
BRAKES  
FREINADO  
TRAVONES  
BREMSE  
FRENATA  
REMDELEN

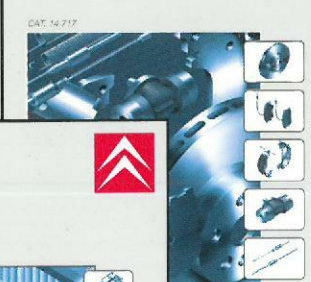

CAT. 14.717

10/0002

FILTRATION  
FILTERS  
FILTROS  
FILTRACÃO  
FILTER  
FILTRAGGIO  
FILTERS

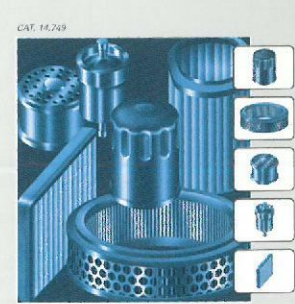

CAT. 14.749

11/2002

CLIMATISATION  
AIR CONDITIONING  
CLIMATIZACION  
AR CONDICIONADO  
KLIMAANLAGE  
CLIMATIZZAZIONE  
AIRCONDITIONING

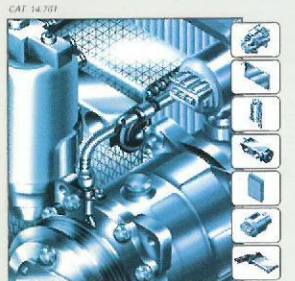

CAT. 14.781

CITROËN

06/2002



CITROËN

Automobiles CITROËN - Siège social : Immeuble Colisée III - 12, rue Fructidor - 75835 Paris Cedex 17 France - Tél. : 01 58 79 79 79  
www.citroen.fr - S.A. au capital de 16 000 000 euros - R.C.S. Paris 642 050 199 - Siret 642 050 199 00644 - APE 741 J

DIRECTION DES SERVICES ET PIECES CITROËN